

# Filling the Knowledge Gaps for Safe Nanotechnology in the Workplace

A Progress Report from the NIOSH Nanotechnology Research Center, 2004–2011

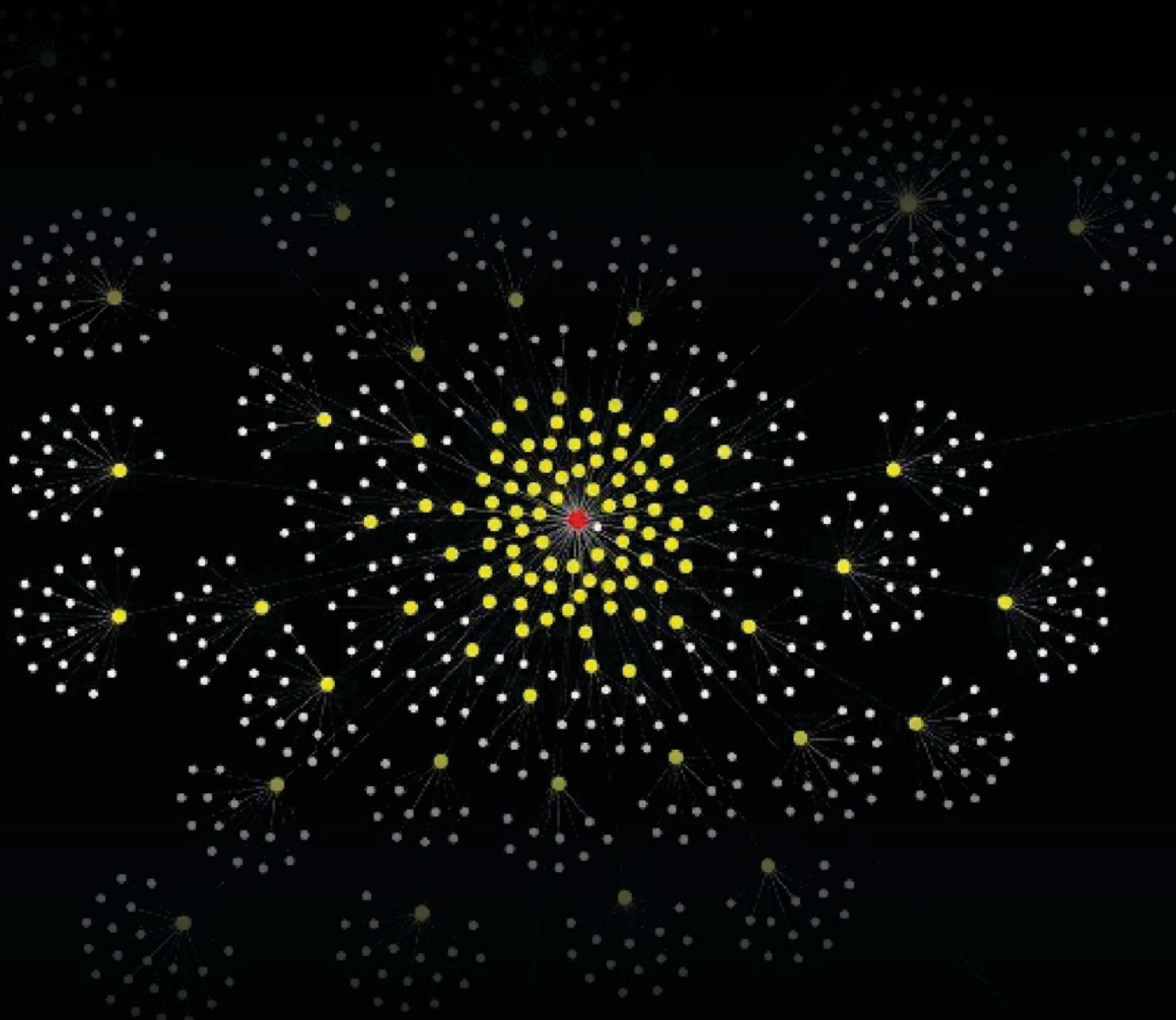

DEPARTMENT OF HEALTH AND HUMAN SERVICES  
Centers for Disease Control and Prevention  
National Institute for Occupational Safety and Health



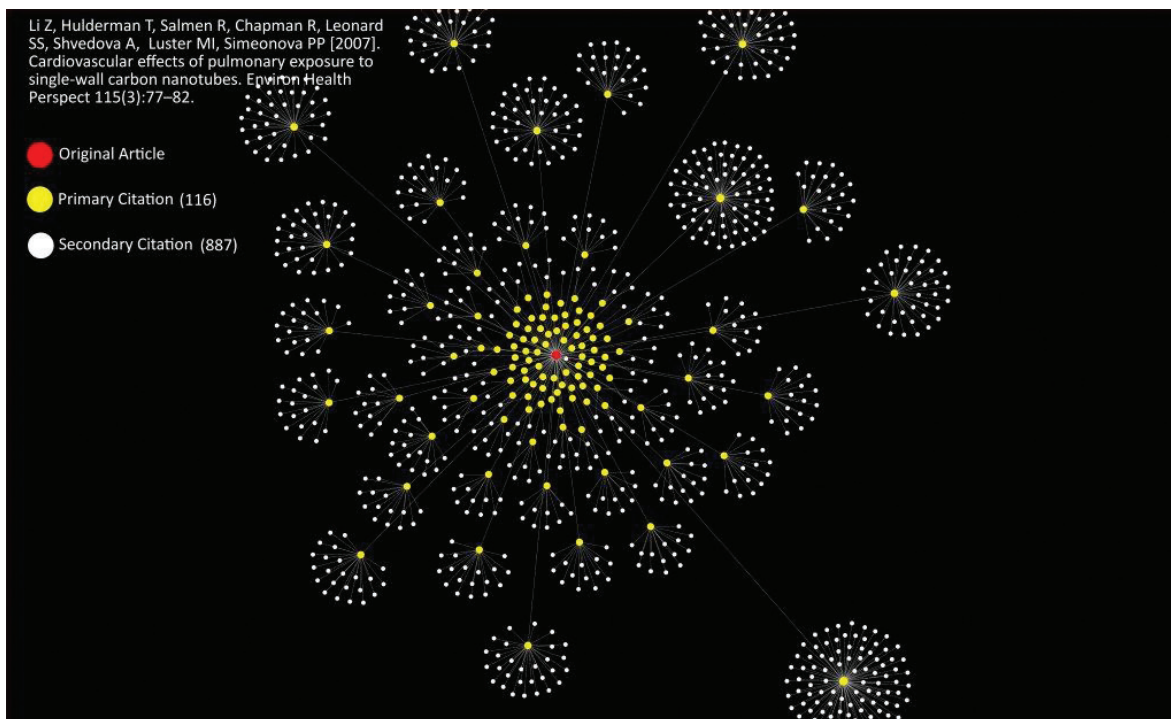

On the cover: A graphical representation of the reach of a highly cited NIOSH journal article specific to nanomaterials. The scatter plot illustrates the initial publication (red dot) surrounded by the number of times it was directly cited in other papers (primary citations are yellow dots) and then the number of times the primary citation papers were cited by other papers (secondary citations are white dots). This diagram was developed using Cytoscape, an open source platform for complex network analysis and visualization.

# Filling the Knowledge Gaps for Safe Nanotechnology in the Workplace

A Progress Report from the NIOSH Nanotechnology Research Center, 2004–2011

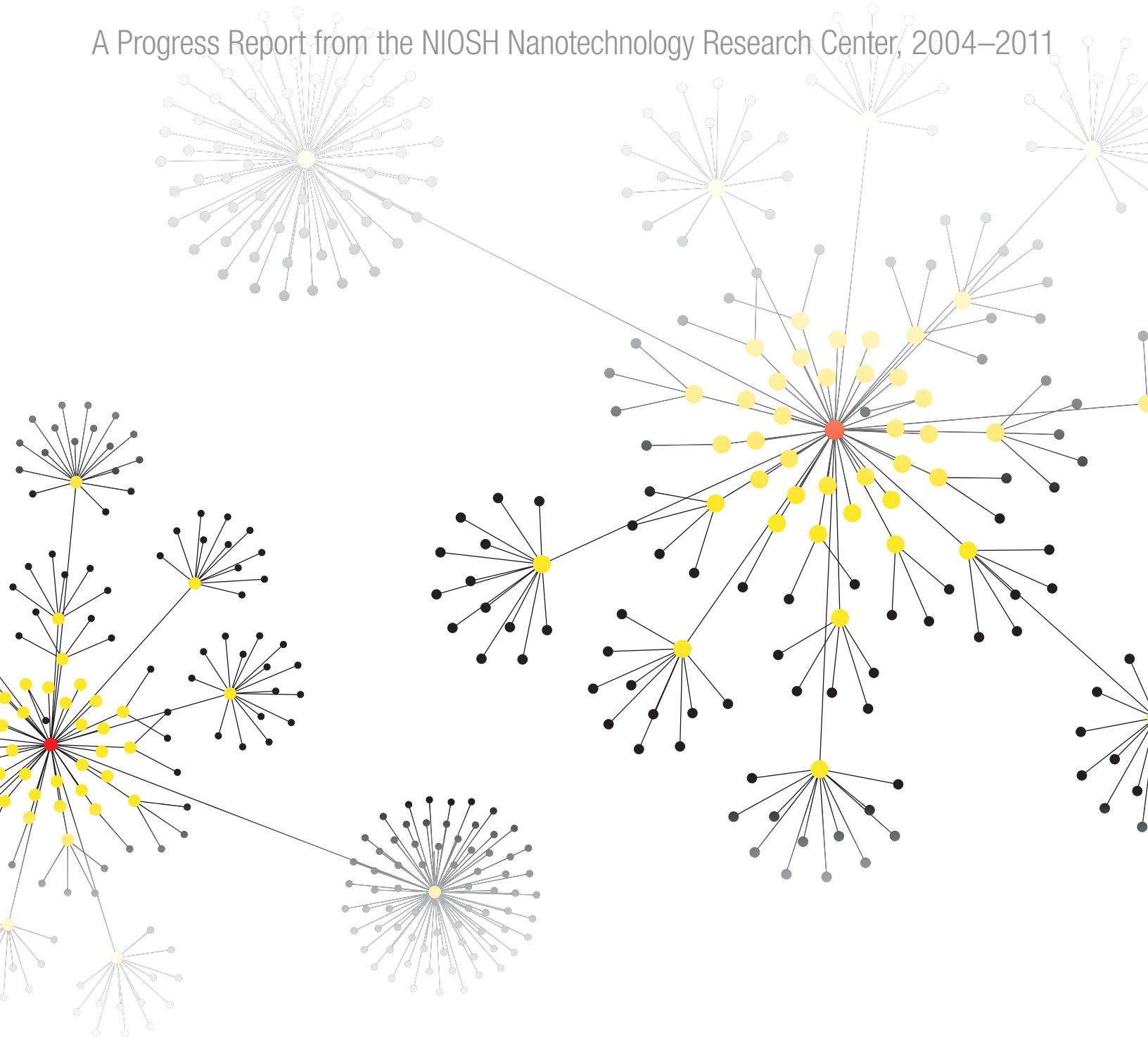

**DEPARTMENT OF HEALTH AND HUMAN SERVICES**  
Centers for Disease Control and Prevention  
National Institute for Occupational Safety and Health



This document is in the public domain and may be freely copied or reprinted.

## Disclaimer

Mention of any company or product does not constitute endorsement by the National Institute for Occupational Safety and Health (NIOSH). In addition, citations to websites external to NIOSH do not constitute NIOSH endorsement of the sponsoring organizations or their programs or products. Furthermore, NIOSH is not responsible for the content of these websites. All Web addresses referenced in this document were accessible as of the publication date.

## Ordering Information

To receive documents or other information about occupational safety and health topics, contact NIOSH:

Telephone: **1-800-CDC-INFO** (1-800-232-4636)

TTY: 1-888-232-6348

E-mail: [cdcinfo@cdc.gov](mailto:cdcinfo@cdc.gov)

or visit the NIOSH website at [www.cdc.gov/niosh](http://www.cdc.gov/niosh).

For a monthly update on news at NIOSH, subscribe to *NIOSH eNews* by visiting [www.cdc.gov/niosh/eNews](http://www.cdc.gov/niosh/eNews).

DHHS (NIOSH) Publication No. 2013-101

November 2012

**SAFER • HEALTHIER • PEOPLE™**



## Foreword

With any new or emerging technology, the greatest period of uncertainty about hazards and associated risks generally occurs in the early stages of development. This is true for engineered nanomaterials, where exposures to the pure and most concentrated form are most likely to occur in the workplace during the research, manufacture, or use of these materials. In 2004, the National Institute for Occupational Safety and Health (NIOSH) established the Nanotechnology Research Center (NTRC) to address the occupational safety and health concerns that might be associated with this new technology. Through the NTRC, NIOSH forged partnerships with other government agencies, countries, academia, industry, labor, and nongovernmental organizations to conduct research on the potential workplace implications and the beneficial applications of nanotechnology. A critical element of the research program is to conduct research on the potential health effects of worker exposure to engineered nanomaterials and to develop guidance in preventing exposure.

In 2007 and 2009, NIOSH published progress reports detailing the accomplishments of the NTRC, including the results of ongoing laboratory and field research and the publication of technical and other guidance documents on the safe handling of engineered nanomaterials (see *Progress Toward Safe Nanotechnology in the Workplace*, [www.cdc.gov/niosh/topics/nanotech/pubs.html](http://www.cdc.gov/niosh/topics/nanotech/pubs.html)). This 2012 update presents the program accomplishments of the NTRC from its inception in 2004 through 2011. It includes an analysis of the progress made toward accomplishing the goals and objectives of the NIOSH Strategic Plan for Nanotechnology Research and toward addressing the goals and research needs identified in the U.S. National Nanotechnology Initiative (NNI) Environmental, Health, and Safety (EHS) research strategy. The NTRC continues to support and promote the responsible development of nanotechnology through its ongoing research program and its contributions to the development of guidelines for hazard identification, exposure assessment, and risk characterization that can be used to develop and implement effective risk management practices.

John Howard, M.D.  
Director, National Institute for Occupational  
Safety and Health  
Centers for Disease Control and Prevention



## Executive Summary

The NIOSH Nanotechnology Research Center (NTRC) was established in 2004 to develop, coordinate, and deliver an organized program of research to identify, investigate, and develop science-based solutions to workplace health and safety knowledge gaps in nanotechnology. The NTRC provides overall strategic direction and coordination of the NIOSH nanotechnology cross-sector research program (<http://www.cdc.gov/niosh/topics/nanotech/>). The responsibilities of the NTRC are in accordance with the legislative mandate issued to NIOSH in Section 20(a) (4) of the Occupational Safety and Health Act of 1970, which states:

*“...conduct special research, experiments, and demonstrations relating to occupational safety and health as are necessary to explore new problems, including those created by new technology in occupational safety and health, which may require ameliorative action beyond that which is otherwise provided for in the operating provisions of this Act.”*

Nanotechnology is a rapidly emerging material science technology that has been identified as a critical U.S. scientific and commercial enterprise with global economic benefits. Concern over the lack of knowledge about the potential health risks associated with the handling of pure, unbound engineered nanomaterials has been expressed by investors, entrepreneurs, government agencies, and public health advocacy groups. Such concerns create potential barriers to the growth of nanotechnology and the commercialization of products and devices that could help address serious global problems concerning energy, transportation, pollution, health, and food. Issues that have been raised about worker health and safety must be addressed to ensure responsible development, societal benefit, and associated economic growth.

### Vision Statement

The NTRC facilitates responsible development of nanotechnology by identifying and addressing gaps in occupational safety and health knowledge. This vision is accomplished by creating a strategic plan of research, coordinating and facilitating the delivery of results, developing and disseminating science-based risk management recommendations, and providing national and world leadership.

### Strategic Plan

In 2005, NIOSH developed a strategic research plan for the NTRC to address critical issues of health and safety associated with nanotechnology. The plan was revised in 2009, and a final report was published following review by the NIOSH Board of Scientific Counselors with input from a work group of subject matter experts. The strategic plan recommended four overarching goals ([www.cdc.gov/niosh/docs/2010-105](http://www.cdc.gov/niosh/docs/2010-105)) [NIOSH 2009a]:

## NIOSH NTRC Strategic Goals

1. Determine whether nanoparticles and nanomaterials pose risks for work-related injuries and illnesses.
2. Conduct research on applying nanotechnology to the prevention of work-related injuries and illnesses.
3. Promote healthy workplaces through interventions, recommendations, and capacity building.
4. Enhance global workplace safety and health through national and international collaborations on nanotechnology research and guidance.

Within these four goals, 10 critical areas of research and communication were identified to serve as the foundation for a comprehensive plan of action:

1. Toxicity and internal dose
2. Measurement methods
3. Exposure assessment
4. Epidemiology and surveillance
5. Risk assessment
6. Engineering controls and personal protective equipment (PPE)
7. Fire and explosion safety
8. Recommendations and guidance
9. Communication and information
10. Applications of nanotechnology for occupational safety and health





**By initiating a plan to conduct concurrent and integrated research in each of these 10 critical areas, NIOSH has undertaken the challenge of addressing the information and knowledge gaps necessary to protect workers so that the ultimate societal benefits of nanotechnology can be realized.**

In 2012, the activities and outputs of the NTRC from 2004 through 2011 (and some projects that carried over into 2012) were evaluated to determine the extent of accomplishing the NTRC Strategic goals. Measurable outputs of the NTRC generally consisted of:

- NIOSH guidance documents, scientific journal publications, and presentations at conferences and workshops
- the development of new technologies, including sampling and analytical methods
- results from NIOSH collaborations and research (toxicology, workplace exposure measurements, engineering control, and epidemiology) used to develop risk management recommendations for the safe handling of nanomaterials
- creation of strategic collaborations and partnerships.

### **Summary of NTRC Program Outputs and Impacts**

Among the many program outputs and impacts, the NTRC researchers:

- Developed some of the earliest guidance on the design and conduct of nanotoxicology studies.
- Identified pulmonary and cardiovascular hazards of some types of carbon nanotubes in animals.
- Determined that the dispersion of ultrafine carbon black nanoparticles in the lungs of rats following intratracheal instillation results in an inflammatory response that is greater than agglomerated ultrafine carbon black.
- Determined that ultrafine TiO<sub>2</sub> or carbon black is more inflammogenic than fine TiO<sub>2</sub> or carbon black on a mass-dose basis.
- Developed a system to generate nanoparticle aerosols for inhalation toxicologic studies.
- Conducted over 40 field assessments in nanomaterial manufacturer and user facilities.
- Produced more than 400 peer-reviewed scientific publications, resulting in over 5,000 primary and 82,000 secondary citations.
- Provided over 650 invited presentations.
- Published a framework for conducting workplace emission testing.
- Developed innovative sampling methods for engineered nanomaterials.
- Contributed to the development of a bio-mathematical model in rats to describe clearance, retention, and translocation of inhaled nanoparticles throughout the body.

- Developed recommended exposure limits (RELs) for TiO<sub>2</sub> and carbon nanotubes (CNTs) and carbon nanofibers (CNFs).
- Developed interim guidance for medical screening and hazard surveillance.
- Identified what research will be needed to ensure the health of workers handling nanomaterials.
- Established formal partnerships and collaborations with private, governmental and academic centers in the U.S. and globally.
- Co-chaired the NNI Nanotechnology Environmental and Health Implications (NEHI) Working Group and contributed significantly to the development of the 2011 NEHI environmental health and safety (EHS) strategy.
- Chaired the Organization for Economic Cooperation and Development (OECD) Working Party on Manufactured Nanomaterials Steering Group 8 on exposure measurement and exposure mitigation for manufactured nanomaterials.
- Provided widely used guidance on responsible development of nanotechnology.
- Helped to establish the U.S. and international position that a precautionary approach to controlling exposures to engineered nanoparticles is warranted.
- Have shown how responsible nanotechnology development and worker safety and health can be achieved.

**Responsible development of nanotechnology must include worker safety and health.** NIOSH has been a leader in identifying hazards of nanomaterials, exposures, and risks to workers and has provided extensive guidance to protect workers in the face of broad uncertainties in these areas. NIOSH hazard identification has vastly increased scientific knowledge about potential hazards of nanomaterials. This increase in scientific knowledge has moved scientists to develop further research and more effectively address knowledge gaps. NIOSH efforts laid the groundwork for generating nanomaterial aerosols so that realistic animal studies could be developed. The investment of \$42.6 million over seven years has served to drive scientific research, as illustrated by the large number of citations of NIOSH publications. Moreover, the pioneering toxicological work served to focus exposure assessment so that the actual exposure of workers could be characterized. Building on the hazard and exposure information, NIOSH developed a broad range of risk management guidance that became a cornerstone in the national and global response to nanotechnology. **NIOSH has helped define the world's precautionary approach to nanotechnology and provided the technical, scientific, and health information to protect workers and develop the technology responsibly.**







## **NTRC Programmatic Reviews**

The NTRC will continue to evaluate its research progress in nanotechnology through a series of programmatic internal and external reviews. For example, past program evaluations have included a review by the National Academies (nanomaterial section of the NIOSH Respiratory Disease program) and a review of the NTRC strategic plan by the NIOSH Board of Scientific Counselors with input from a work group of subject matter experts. One result of these programmatic reviews was the creation of a more focused set of research priorities for 2009–2012. The NIOSH research strategy is consistent with the recommendations of the President’s Council of Advisors on Science and Technology (PCAST) report to the President on the third and fourth assessment of the NNI (<http://nano.gov/node/786>). Internally, the NTRC will continue to conduct annual program reviews, conduct regular project reviews, and publish a biannual or triannual Progress Report.

## Contents

Forward.....	iii
Executive Summary .....	iv
Abbreviations.....	xiii
Acknowledgments.....	xviii
1 Introduction .....	1
2 Qualitative Assessment on Meeting the NTRC Goals .....	3
3 Alignment with the NNI EHS Strategy .....	53
4 NIOSH Extramural Nanotechnology Research Activities .....	55
5 The Next Steps .....	57
6 References .....	59
Appendix A: Project Specific Progress Reports.....	63
Project 1: Nanotechnology Research Center Coordination.....	71
Project 2: Nanotechnology Safety and Health Research Coordination (Nanotoxicology) .....	92
Project 3: Development of New Research in Occupational Health (Nanotoxicology) .....	96
Project 4: Systemic Microvascular Dysfunction: Effects of Ultrafine vs. Fine Particles .....	102
Project 5: Particle Surface Area as a Dose Metric .....	105
Project 6: Role of Carbon Nanotubes in Cardiovascular and COPD-Related Diseases .....	108
Project 7: Investigations of Multi-walled Carbon Nanotube Toxicity .....	112
Project 8: Toxicological Effects of Aerosolized MWCNT .....	116
Project 9: Pulmonary Toxicity of Metal Oxide Nanospheres and Nanowires..	118
Project 10: WC-Co Nanoparticles in Initiating Angiogenesis by Reactive Oxygen Species .....	121
Project 11: Evaluation of the Pulmonary Deposition and Translocation of Nanomaterials.....	123
Project 12: Occupational Exposures and Potential Neurological Risks .....	127
Project 13: Lung Effects of Resistance Spot Welding with Adhesives.....	132
Project 14: Neurotoxicity after Pulmonary Exposure to Welding Fumes .....	133
Project 15: Welding Fumes and Cardiovascular Dysfunction.....	138
Project 16: Potential Aneuploidy Following Exposure to Carbon Nanotubes...	139
Project 17: Nanoparticle Properties and Mechanisms Causing Lung Fibrosis.....	144
Project 18: Pulmonary Toxicity of Carbon Nanotube Particles.....	148



Project 19: Assessment of Engineered Nanomaterials of Respiratory Immunity .....	154
Project 20: Dermal Toxicity of Nanotube Particles .....	159
Project 21: Bioassay Screen of Lung Toxicity of Silver Nanoparticles .....	164
Project 22: Specific Biomarkers for Unusual Toxicity of Nanomaterials .....	166
Project 23: Pulmonary Toxicity of Diesel Exhaust Particles .....	168
Project 24: Induction of Lung Fibrosis by Cerium Oxide in Diesel Exhaust. . .	170
Project 25: Potential Effects of Silicon-based Nanowires on Lung Toxicity. . .	173
Project 26: Workplace Exposure, Inflammation, and Cardiovascular Toxicity. .	177
Project 27: Cardiovascular Toxicity Assessment of Subchronic Inhalation Exposure to Fullerene C60. ....	180
Project 28: Cell-Based Assessment for Iron Nanoparticle-Induced Health Risks	181
Project 29: Assessment of Carbonaceous Materials on Mutagenicity .....	183
Project 30: Durability of Nanoscale Cellulose Fibers in Artificial Human Lung Fluids .....	185
Project 31: Osteopontin and Carbon Nanotubes .....	186
Project 32: Determination of Diameter Distribution for Carbon Nanotubes by Raman Spectroscopy. ....	187
Project 33: Inhalation Facility Support .....	188
Project 34: Generation and Characterization of Nanoparticles .....	196
Project 35: Dustiness of Nanomaterials .....	200
Project 36: Measurement of Nanoscale Carbonaceous Aerosols .....	202
Project 37: Nanoaerosol Monitoring Methods (formerly Automotive Ultrafine Intervention) .....	204
Project 38: Workplace Monitoring of Carbon Nanofibers/Nanotubes. ....	210
Project 39: Real-time Instrument for Nanoaerosol Exposure Measurement . . .	215
Project 40: Nanoparticle Reference Materials for Health Protection .....	218
Project 41: International Coordination of Nanoscale Reference Materials. . . .	220
Project 42: A Standard Method for Determining Airborne Nanoparticle Size .....	222
Project 43: Calm Air Chamber and Wind Tunnel Evaluation of Personal Aerosol Samplers for Nanoparticle Exposure Assessment .....	223
Project 44: Efficacy of NIOSH Method 0600 for Fine and Ultrafine Titanium Dioxide .....	224
Project 45: Ultrafine TiO <sub>2</sub> Surface and Mass Concentration Sampling Method .....	225
Project 46: Development and Evaluation of Nanoaerosol Surface Area Measurement Methods .....	227

Project 47: Respiratory Deposition of Airborne Carbon Nanotubes . . . . .	230
Project 48: Exposure Potential From Use of Nanomaterial-Enabled Consumer Products . . . . .	232
Project 49: Ultrafine Aerosols from Diesel-Powered Equipment . . . . .	233
Project 50: Titanium Dioxide and Other Metal Oxides Exposure Assessment Study . . . . .	237
Project 51: Field Research Team . . . . .	239
Project 52: Factors Affecting Exposure to Engineered Nanomaterials. . . . .	244
Project 53: Assessing the Feasibility of Industrywide Exposure and Epidemiology Studies of Workers Exposed to Engineered Nanomaterials—Phase I . . . . .	247
Project 54: Engineered Carbon Nanomaterials Workforce: Feasibility of Industrywide Exposure Assessment and Epidemiology Studies on Carbon Nanotubes and Nanofibers—Phase II . . . . .	249
Project 55: Nanoparticles—Dosimetry and Risk Assessment . . . . .	252
Project 56: Titanium Dioxide Quantitative Risk Assessment . . . . .	259
Project 57: Engineering Controls for Nanomaterial Handling . . . . .	261
Project 58: Applying PtD to the Safe Handling of Engineered Nanomaterials . .	264
Project 59: Penetration of Nanoparticles Through Respirators/Development of Respirator Filtration Test Methods . . . . .	265
Project 60: Nanoparticle Penetration through Protective Clothing . . . . .	270
Project 61: Respirator Performance Against Engineered Nanoparticles Under Laboratory and Workplace Settings. . . . .	271
Project 62: Development of Personal Protective Equipment Ensemble Test Methods . . . . .	274
Project 63: Explosibility and Flammability of Carbon Nanotubes . . . . .	277
Project 64: Current Intelligence Bulletin: Carbon Nanotubes and Carbon Nanofibers. . . . .	279
Project 65: Assessing the Utility of Control Banding in the U.S. . . . .	281
Project 66: Web-based Nanoparticle Information Library Implementation . . .	283
Project 67: Nanoparticles in the Workplace and Metrics for Field and Toxicity Studies . . . . .	286
Project 68: Global Harmonization of Exposure Measurement and Exposure Mitigation Approaches for Nanomaterials . . . . .	297
Project 69: New Sensor Technology Development for Filter Respirator Cartridge End-of-Service Life Indicators (ESLI) . . . . .	305
Appendix B: NTRC Projects in the 10 Critical Areas for 2004–2011 . . . . .	309
Appendix C: NIOSH Extramural Research . . . . .	317
Appendix D: NIOSH Logic Model . . . . .	373



Appendix E: Progress Toward Meeting the NTRC Performance Measures . . . . . 377  
Appendix F: Summary of the Citation Analysis. . . . . 395



## Abbreviations

AIHA	American Industrial Hygiene Association
AIHce	American Industrial Hygiene conference and exposition
ACGIH	American Conference of Governmental Industrial Hygienists
AM	alveolar macrophage
ANSI	American National Standards Institute
AP-1	activator protein 1
APR	air-purifying respirators
ASME	American Society of Mechanical Engineers
ASSE	American Society of Safety Engineers
ASTM	American Society for Testing and Materials
ATP	adenosine triphosphate
BAL	bronchoalveolar lavage
CARB	California Air Resources Board
CDC	Centers for Disease Control and Prevention
CD-ROM	compact disc, read only memory
CIB	Current Intelligence Bulletin
CMPND	Center for Multifunctional Polymer Nanomaterial and Devices
CNF	carbon nanofiber
CNSE	College of Nanoscale Science and Engineering
CNT	carbon nanotube
CO	carbon monoxide
COIN	Center of Innovation for Nanobiotechnology
COPD	chronic obstructive pulmonary disease
CPC	condensation particle counter
CPSC	Consumer Product Safety Commission
DDT	dichlorodiphenyltrichloroethane
DEP	diesel exhaust particulate
DEER	diesel engine-efficiency and emissions research
DEPE	diesel exhaust particulate extract
DETR	Developmental Engineering Research Team
DHHS	U.S. Department of Health and Human Services
DIC	different interference confocal
DNA	dioxyribonucleic acid
DOD	U.S. Department of Defense



DOE	U.S. Department of Energy
DPF	diesel particulate filter
EC-SOD	extracellular superoxide dismutase
EHS	environmental, health, and safety
ELSI	ethical, legal, and societal implications
EPA	U.S. Environmental Protection Agency
ERC	Education and Research Center
ESLI	end of service-life indicator
ESP	electrostatic precipitator
ESR	erythrocyte sedimentation rate
EU	European Union
FASEB	Federation of American Societies for Experimental Biology
FCA-SS	flux core arc-stainless steel
FDA	U.S. Food and Drug Administration
FISH	fluorescent in situ hybridization
FY	fiscal year
GAO	U.S. Government Accountability Office
GMA-MS	gas metal arc-mild steel
HEI	Health Effects Institute
HEPA	high-efficiency particulate air filter
HHE	Health Hazard Evaluation
HPS	Health Physics Society
IANH	International Alliance for NanoEHS Harmonization
ICOH	International Commission on Occupational Health
ICON	International Council on Nanotechnology
IDLH	immediately dangerous to life and health
IEC	International Electrotechnical Commission
IOHA	International Occupational Hygiene Association
IOM	Institute of Occupational Medicine
ILO	International Labor Organization
ILSI	International Life Sciences Institute
ISO	International Organization for Standardization
IRSST	Institut de recherché Robert-Sauvè en santé et en sécurité du travail
JOEH	Journal of Occupational and Environmental Hygiene
JOEM	Journal of Occupational and Environmental Medicine
kW	kilowatt

LDH	lactate dehydrogenase
LEV	local exhaust ventilation
LLC	limited liability company
LM	<i>Listeria monocytogenes</i>
LNW	long nanowire
MAPKs	mitogen-activated protein kinase
MINChar	Minimum Information Needed for Characterization of Nanomaterials
MMA-HS	manual metal arc-hard surfacing
MOU	Memorandum of Understanding
MOUDI	micro-orifice uniform deposit impactor
MPPD	multipath particle deposition
MWCNT	multi-walled carbon nanotube
NADPH	nicotinamide adenine dinucleotide phosphate
NASA	National Aeronautics and Space Administration
NATO	North Atlantic Treaty Organization
NCER	National Center for Environmental Research
NEAT	nanoparticle emission assessment technique
NEHI	Nanotechnology Environmental and Health Implications
NFκB	nuclear factor kappa beta
NGO	non-governmental organization
NIEHS	National Institute of Environmental Health Sciences
NIH	National Institutes of Health
NIL	Nanoparticle Information Library
NIOSH	National Institute for Occupational Safety and Health
NIST	National Institute of Standards and Technology
nm	nanometer(s)
NNI	National Nanotechnology Initiative
NO	nitric oxide
NORA	National Occupational Research Agenda
NS	nanosphere
NSC	National Safety Council
NSET	Nanoscale Science, Engineering, and Technology
NSF	National Science Foundation
NSTC	National Science and Technology Council
NTP	National Toxicology Program
NTRC	Nanotechnology Research Center



OEP	Office of Extramural Programs
OECD	Organization for Economic Cooperation and Development
OEP	Office of Extramural Programs
OH&S	occupational health and safety
ONAMI	Oregon Nanoscience and Microtechnologies Institute
OPC	optical particle counter
OPN	osteoportun
OSHA	U.S. Occupational Safety and Health Administration
PAMS	portable aerosol mobility spectrometer
PEL	permissible exposure limit
PEROSH	Partnership for European Research in Occupational Safety and Health
PMN	polymorphonuclear neutrophil
PNS	personal nanoaerosol sizer
POSS	polyhedral oligomeric silsesquioxane
PPE	personal protective equipment
r2p	Research to Practice
RELS	recommended exposure limits
RFA	request for application
RMs	reference materials
RNS	reactive nitrogen species
ROI	return on investment
ROS	reactive oxygen species
SBIR	small business innovation research
SEMATECH	semiconductor manufacturing technology consortium
SG	steering group
SMPS	scanning mobility particle sizer
SNW	short nanowire
SRM	standard reference material
STEL	short-term exposure limit
SWCNT	single-walled carbon nanotube
TAPPI	Technical Association of the Pulp and Paper Industry
TC	technical committee
TEM	transmission electron microscopy
TGF- $\beta$	transforming growth factor-beta
TiO <sub>2</sub>	titanium dioxide

TNO	Nederlandse Organisatie voor Toegepast Natuurwetenschappelijk Onderzoek (Netherlands Organization for Applied Scientific Research)
TR	technical report
$\mu\text{g}/\text{m}^3$	microgram per cubic meter
UK	United Kingdom
UN	United Nations
UNITAR	United Nations Institute for Training and Research
USAF	U.S. Air Force
VEGF	vascular endothelial growth factor
Wc-Co	tungsten carbide
WHO	World Health Organization
WT	wild type





## Acknowledgments

This report was developed by the scientists and staff of NIOSH who participate in the Nanotechnology Research Center (NTRC). Paul Schulte is the manager and Charles Geraci is the coordinator of the NIOSH National Occupational Research Agenda (NORA), Nanotechnology cross-sector program. Special thanks go to Laura Hodson for writing and organizing the report. Others who contributed substantially to this progress report include James Antonini, Eileen Birch, Vincent Castranova, Teh-hsun Chen, Brian Curwin, Matt Dahm, Min Ding, Kevin Dunn, Aaron Erdely, Douglas Evans, Larry Foster, Pengfei Gao, Mark Hoover, Bon-Ki Ku, Eileen Kuempel, Pramod Kulkarni, Stephen Leonard, Li Ming Lo, Jane Ma, Ken Martinez, Robert Mercer, Mark Methner, Vladimir Murashov, Terri Pearce, Dale Porter, Viji Potula, Yong Qian, Appavoo Rengasamy, Jennifer Roberts, Liying Wang Rojanasakul, Linda Sargent, Mary Schubauer-Berigan, Ronald Shaffer, Anna Shvedova, Jay Snyder, Krishnan Sriram, Aleksandr Stefaniak, Jennifer Topmiller, Douglas Trout, Leonid Turkevich, and Ralph Zumwalde.

The NIOSH NTRC also acknowledges the contributions of Vanessa Williams, Gino Fazio, Eric Gentry, and Rachel Thieman for the publication design and production and Seleen Collins for editing. Photographs are courtesy of Catherine Beaucham, Teh-hsun Chen, Matt Dahm, Doug Evans, Mark Hoover, Robert Mercer, Ken Martinez, Mark Methner, and Leonid Turkevich.

Thanks are extended to Cathy Sarli and Kristi Holmes, Washington University in St. Louis School of Medicine, for their advice in developing the progress report.

### External Peer Reviewers

Jay West  
Senior Director, Regulatory and Technical Affairs  
American Chemistry Council

William Kojola  
Industrial Hygienist  
The American Federation of Labor–Congress of  
Industrial Organizations (AFL-CIO)

Janet Carter  
Industrial Hygienist  
U.S. Occupational Safety and Health Administration

# 1 Introduction

Historically, the commercial development and application of some potentially useful substances have turned out to have negative health consequences among producers and users if those potential impacts are not identified and investigated early. For example, asbestos was commercially used because of its good insulating and fireproofing properties, but later it was determined to cause significant health problems 20 to 40 years after exposure. Other useful chemicals such as DDT (for eradicating mosquitoes and reducing the incidence of malaria) and lead (for antimicrobial uses and paint formulations) were also determined to be detrimental to human health and the environment, years after they were put into commerce. Mass production of chemicals before investigating potential health concerns and societal impacts has significant human burden and financial repercussions because of the high cost of remedial actions to remove these hazardous materials (e.g., asbestos, lead) and because of the medical and liability costs incurred for compensating individuals with an exposure-related disease or injury.

Nanotechnology and the commercialization of nanoenabled products and devices could help address serious global problems concerning energy, transportation, pollution, health, medicine, and food. The potential benefits of nanotechnology are huge; however, these benefits may not be realized unless a concerted effort is made to evaluate the safety and health concerns regarding these new nanomaterials and to develop effective methods for their responsible introduction. This concern is supported by an industry survey in which nanotechnology business leaders identified health and safety issues as a key barrier to commercialization of their products [Lekus et al. 2006; U.S. Department of Commerce 2007].

NIOSH is committed to promoting the responsible development and advancement of nanotechnology through its research and communication efforts to protect workers. It is difficult to estimate how many workers are involved in this field. Nanotechnology is not one specific type of chemical or industry but more of a scientific understanding and capability that can be used to improve nearly every material in commerce and to make a wide variety of new types of chemicals, materials, and products. By one estimate, there are 400,000 workers worldwide in the field of nanotechnology, with an estimated 150,000 of those in the United States [Roco et al. 2010]. The National Science Foundation has estimated that approximately 6 million workers will be employed in nanotechnology industries worldwide by 2020 (<http://nano.gov/node/622>).

The total NIOSH Nanotechnology Research Center (NTRC) intramural investment from FY 2004 to FY 2011 was \$42.7 million (Figure 1). In that same timeframe there was an additional \$12 million\* investment in the funding of extramural research through grants from the NIOSH Office of Extramural Programs (OEP). This total investment included research (e.g., toxicology, field studies) on ultrafine particulates (i.e., nanoscale particles), during 2004 to 2006, and a portfolio of projects focused specifically on engineered nanomaterials, from 2006 to 2011. The majority of the NIOSH investment in nanotechnology research involved reprogrammed funds, with no additional funds received through or as a part of the National Nanotechnology Initiative (NNI).

---

\*This represents all extramural projects that in any way include nanomaterials. Projects may not necessarily be 100% nanotechnology, but rather a portion of the research includes nanomaterials.

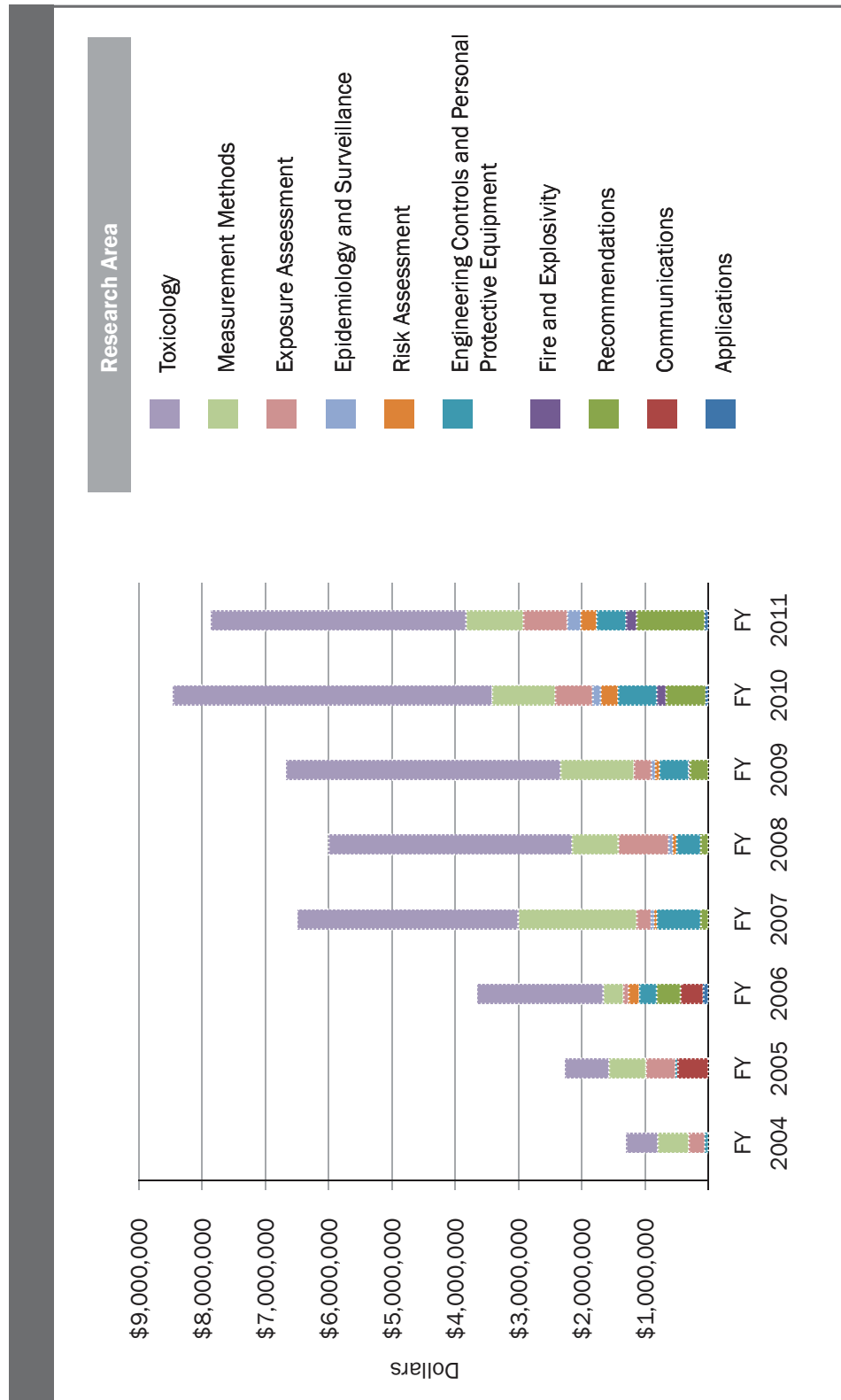

Figure 1. NTRC Intramural funding by fiscal year (FY) and critical research area.

## 2 Qualitative Assessment on Meeting the NTRC Goals

In 2005, NIOSH developed a strategic research plan for the NTRC to address critical issues of health and safety associated with nanotechnology. The plan was updated in 2009 (Figure 2), and a final report was published following review by the NIOSH Board of Scientific Counselors with input from a work group of subject matter experts. The strategic plan recommended four overarching goals [[www.cdc.gov/niosh/docs/2010-105](http://www.cdc.gov/niosh/docs/2010-105)] [NIOSH 2009a]:

### NIOSH NTRC Strategic Goals

1. Determine whether nanoparticles and nanomaterials pose risks for work-related injuries and illnesses.
2. Conduct research on applying nanotechnology to the prevention of work-related injuries and illnesses.
3. Promote healthy workplaces through interventions, recommendations, and capacity building.
4. Enhance global workplace safety and health through national and international collaborations on nanotechnology research and guidance.

Within these four goals, 10 critical areas of research and communication were identified to serve as the foundation for a comprehensive plan of action:

1. Toxicity and internal dose
2. Measurement methods
3. Exposure assessment
4. Epidemiology and surveillance
5. Risk assessment
6. Engineering controls and personal protective equipment (PPE)
7. Fire and explosion safety
8. Recommendations and guidance
9. Communication and information
10. Applications of nanotechnology for occupational safety and health

To ensure an effective nanotechnology research program, projects were initiated to address each element of the risk management process (Figure 3). Areas of research were chosen that support and compliment the portfolio of projects within the NTRC research program, and activity was started in each risk management area. For example, concurrent with the generation of nanoparticle exposures for toxicology research were development and assessment of sampling and analytical methods that could be used for quantifying worker exposures so that comparisons could be made with toxicology study

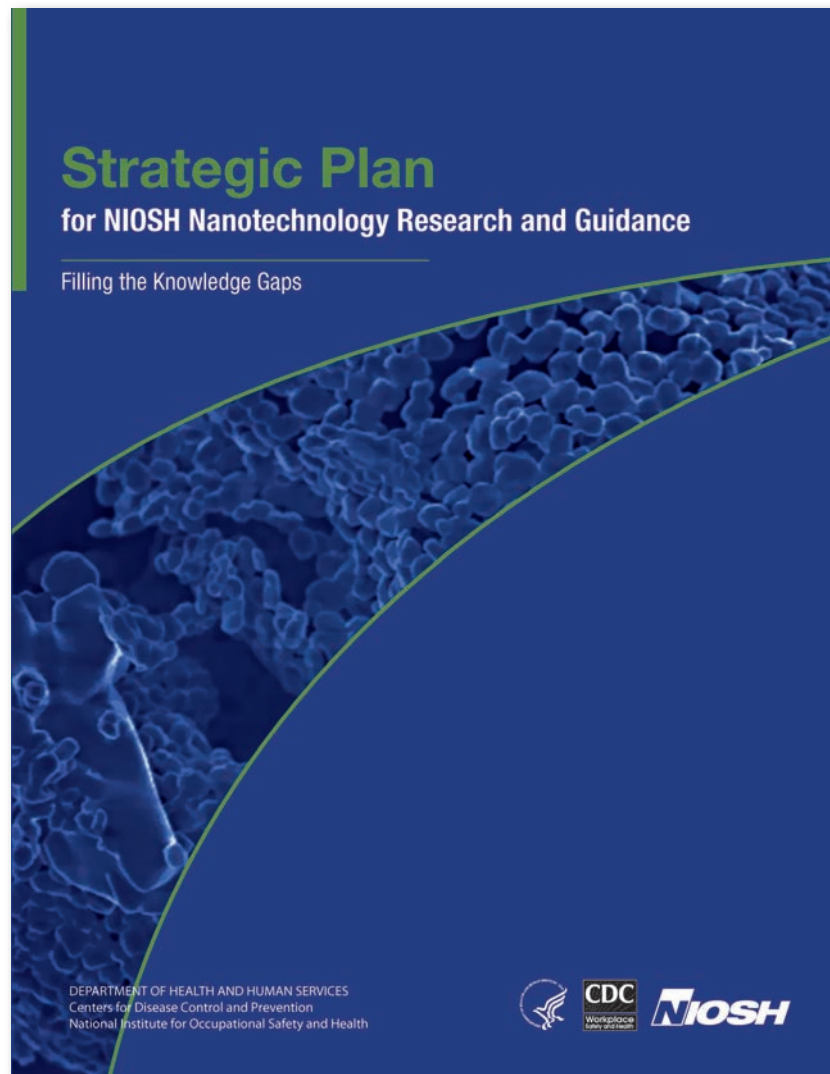

**Figure 2.** Cover of the *Strategic Plan for NIOSH Nanotechnology Research and Guidance*, 2009.

results. Parallel research efforts have also been undertaken to determine 1) the strengths and weaknesses of different risk management strategies for controlling worker exposure to airborne nanoparticles and 2) the types of personal protective equipment (PPE) that might be required to protect exposed workers. As findings of field investigations and laboratory research become available, the information will be used to develop and update guidance for evaluating and managing potential risk from nanomaterials.

### **Program Evaluation Strategy**

The success of a research program is frequently determined by how the results (or outputs) from research activities meet the intended program objectives and advance

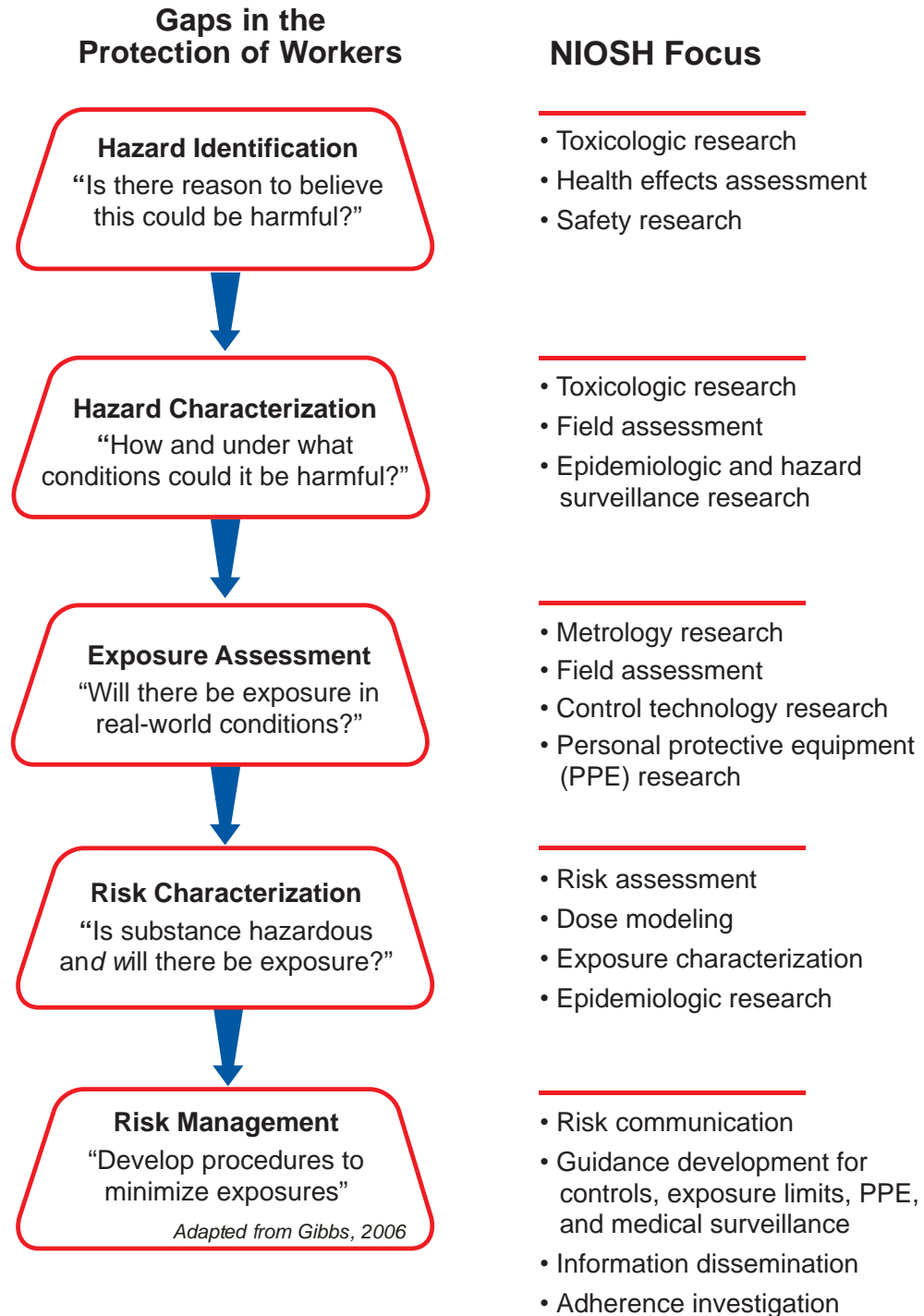

Figure 3. Gaps that need to be filled to protect nanomaterial workers.



knowledge and ultimately stakeholder needs [Sarli et al. 2010]. The NTRC has identified the following outputs as a means of measuring the success of its research program: 1) scientific journal publications, publication and dissemination of NIOSH guidance documents, and communication of research through presentations at scientific (technical) and business conferences and workshops; 2) the development and dissemination of new technologies, including sampling and analytical methods; and 3) results from NTRC research (toxicology and workplace exposure measurements) used to develop risk assessment, characterization, and management strategies. Research outputs for each of the 10 critical research areas follow.

## 2.1 Nanotoxicology and Internal Dose

In the early 2000s, little was known about the potential hazards of engineered nanomaterials, but there was concern that smaller particles with increased surface-to-mass ratios could be highly reactive and cause adverse effects. NTRC nanotoxicologic research is critical to understanding the potential health risks to workers exposed to engineered nanomaterials. Results from experimental animal studies with engineered nanomaterials have provided evidence that some nanoparticle exposures can result in serious health effects involving pulmonary and cardiovascular systems and possibly other organ systems. NTRC researchers have conducted or participated in the following research activities:

- Determined that asbestos and carbon nanotubes (CNTs) affect similar molecular signaling pathways in cultured lung cells, with asbestos exhibiting greater potency
- Determined that nano or ultrafine titanium dioxide (TiO<sub>2</sub>) causes pulmonary inflammation and neuroimmune responses
- Determined that ultrafine TiO<sub>2</sub> or carbon black is more inflammatory than fine TiO<sub>2</sub> or carbon black on a mass-dose basis
- Developed a method to improve dispersion of nanoparticles in biologically compatible suspension media for use in in vitro studies and in vivo exposures employing intratracheal instillation or aspiration of nanoparticle suspensions
- Determined that the dispersion of ultrafine carbon black nanoparticles in the lungs of rats following intratracheal instillation results in an inflammatory response that is greater than with agglomerated ultrafine carbon black
- Determined that pulmonary exposure to single-walled carbon nanotubes (SWCNTs) and multi-walled carbon nanotubes (MWCNTs) in mice causes acute and chronic systemic responses associated with adverse cardiovascular effects
- Determined that SWCNTs, MWCNTs, and carbon nanofibers (CNFs) have equal or greater potency in causing adverse health effects in laboratory animals, including pulmonary inflammation and fibrosis, in comparison with other inhaled particles (ultrafine TiO<sub>2</sub>, carbon black, crystalline silica, and asbestos)



- Determined that CNTs are genotoxic and can transform lung epithelial cells after long-term, low-dose in vitro exposure
- Developed methods for labeling CNTs so that their potential translocation from the lungs to other organs can be studied
- Developed some of the earliest guidance on the design and conduct of nanotoxicology studies
- Co-sponsored a number of nanotoxicology conferences to promote dissemination and growth of scientific information

By conducting some of the world's leading animal and cellular laboratory studies, NTRC researchers have identified a broad range of potential health effects associated with exposure to engineered nanoparticles as well as the physical and chemical characteristics of these nanomaterials that potentially contribute to their biologic activity. The significance of this research is evidenced by the number of times the results of NTRC research have been cited by other researchers. To date, the most highly cited NTRC paper is a sentinel toxicologic study report authored by Anna Shvedova and colleagues, *Exposure to Carbon Nanotube Material: Assessment of Nanotube Cytotoxicity using Human Keratinocyte Cells*. This report has generated 505 primary and 16,482 secondary publication citations (Figure 4) [Shvedova et al. 2003]. This sentinel paper was also cited in 14 patents (or patent applications) from three patent offices [World Intellectual Property Organizations, European Patent Office, and US Patent and Trademark Office] as well as in university theses and dissertations from the US, Germany, United Kingdom, Hong Kong, Switzerland, and France [Elsevier SciVerse Scopus database]. The paper was published in 2003 prior to the official formation of the NIOSH NTRC but after NIOSH began conducting nanotoxicology research.

Other frequently cited NTRC research results include those reported by Maynard et al. [2004] (*Exposure to Carbon Nanotube Material during the Handling of Unrefined Single Walled Carbon Nanotube Material*), with 363 primary and 14,587 secondary publication citations (Figure 5) and cited in 8 patent applications, and those reported by Shvedova et al. [2005] (*Unusual Inflammatory and Fibrogenic Pulmonary Responses to Single Walled Carbon Nanotubes in Mice*), with 449 primary and 9,777 secondary publication citations and cited in 1 patent. Citation data were compiled by using Google Scholar, Thomson Reuters *Web of Knowledge*, and Elsevier SciVerse Scopus database.

The research published by Li et al. [2007] entitled *Cardiovascular Effects of Pulmonary Exposure to Single-Wall Carbon Nanotubes* was nominated for the Charles C. Shepard Science Award (given by the Centers for Disease Control and Prevention [CDC], Department of Health and Human Services). This research was also highlighted as the "Hot-off-the-Presses Peer-Reviewed Research Article" in the *EHS Nano News* [www.ehsnanonews.com/] as one of the first investigations on the potential cardiovascular effects of pulmonary exposure to SWCNTs.



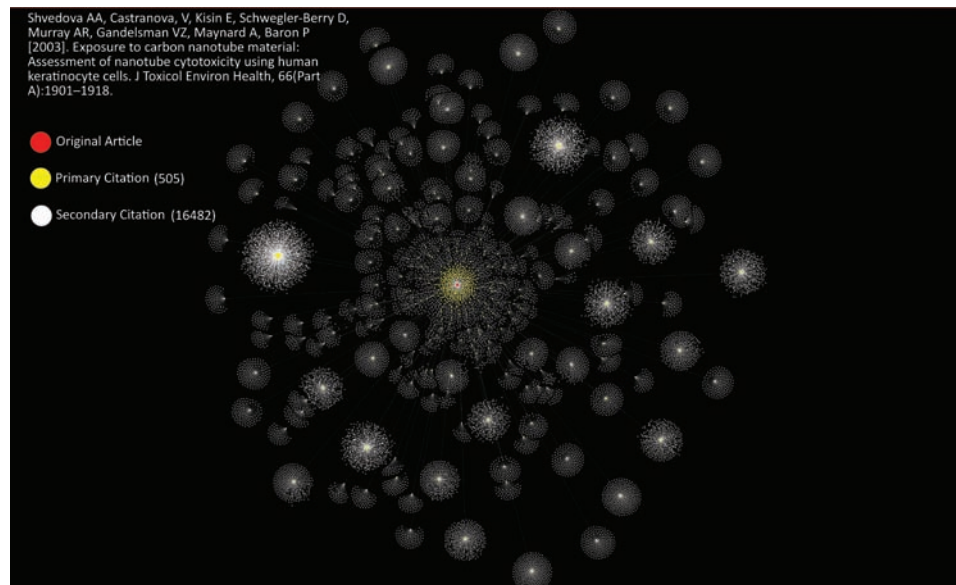

**Figure 4.** A graphical representation of the 505 primary and 16,482 secondary citations of the 2003 article *Exposure to Carbon Nanotube Material: Assessment of Nanotube Cytotoxicity using Human Keratinocyte Cells*. The scatter plot illustrates the initial publication (red dot) surrounded by the number of times it was directly cited in other papers (primary citations are yellow dots) and then the number of times the primary citation papers were cited by other papers (secondary citations are white dots). This diagram was developed with Cytoscape, an open source platform for complex network analysis and visualization.

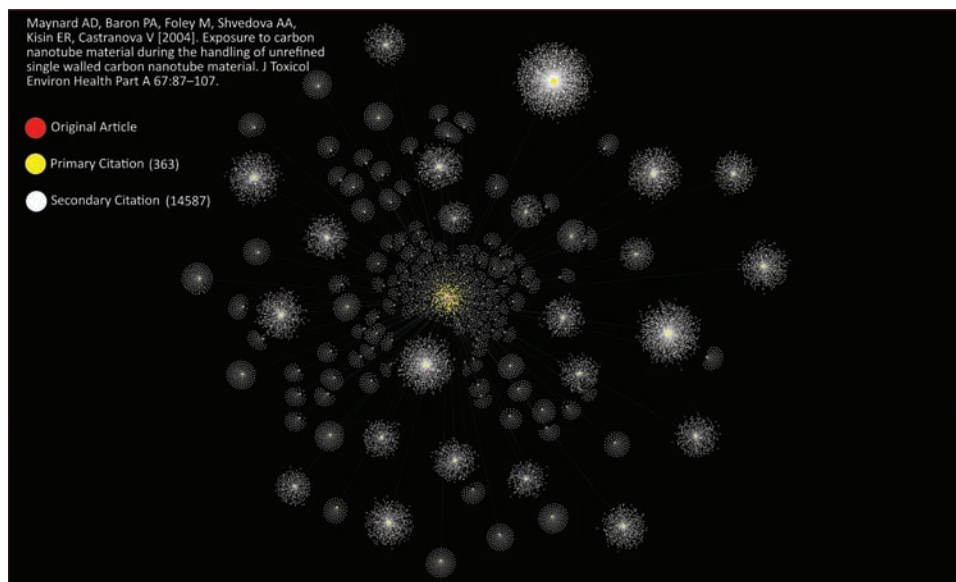

**Figure 5.** A graphical representation of the 363 primary and 14,587 secondary citations of the 2004 article *Exposure to Carbon Nanotube Material during the Handling of Unrefined Single Walled Carbon Nanotube Material*.

### 2.1.1 Development of Innovative Technologies

To conduct experimental animal studies with nanoparticles, NTRC researchers designed an innovative aerosol exposure system to generate particles of specific size for animal inhalation studies [McKinney et al. 2009] (Figures 6 and 7). This system has allowed NTRC researchers to generate airborne exposures to various nanoscale materials (e.g., CNT, crystalline silica, TiO<sub>2</sub>) for toxicological studies. The results from these studies have provided the scientific evidence necessary to make workplace risk management recommendations. The scientific community has expressed interest in the design of this technology, and groups from Japan, England, and Germany have requested information. Researchers from Fraunhofer-Institut, Germany, also visited the NIOSH facilities to learn how to construct their own inhalation exposure system for generating nanofiber exposures.

## 2.2 Measurement Methods

Accurate exposure measurement methods are important for assessing the potential health risk to workers and for validating the effectiveness of exposure controls. Since 2004, NTRC researchers have set the precedent for characterizing occupational exposures to engineered nanoparticles by using both standardized and nonstandardized sampling and analytical techniques. Experience gained from this research has led to the publication of the *Nanomaterial Emission Assessment Technique (NEAT)*, which established the initial framework for NTRC researchers and others in evaluating workplace nanomaterial emissions [Methner et al. 2010]. This stratified (or tiered) exposure emission strategy recommended the assessment of workplace exposures using both commonly applied measurement techniques (e.g., determination of particle count and elemental mass) and more sophisticated nanoparticle analysis (e.g., characterization by electron microscopy). Information gained from the evaluation of workplace exposures was incorporated in the NIOSH 2009 document *Approaches to Safe Nanotechnology: Managing the Health and Safety Concerns Associated with Engineered Nanomaterials* [<http://www.cdc.gov/niosh/docs/2009-125/>].

NTRC researchers were the first to utilize elemental carbon as a selective marker for quantifying CNF and CNT worker exposure [Mether et al. 2007, Birch et al. 2011]. From a direct reading instrument perspective, NTRC researchers observed that respirable particle mass was a more practical monitoring metric than particle number, because the latter metric may be dominated by other particle sources in the workplace [Evans et al. 2010]. As a result, NIOSH field investigations routinely include continuous monitoring of respirable particle mass in addition to other particle metrics (Figure 8). The Evans et al. [2010] publication received the NIOSH 2011 Alice Hamilton Award in the category of Engineering and Physical Sciences.

NTRC researchers continue to refine nanomaterial exposure characterization strategies, using data gathered from ongoing workplace exposure measurement studies and from participation in the global dialogue on this topic. The results from workplace studies on CNT and CNF during 2010–2011 have contributed to the development and advancement of measurement techniques for these carbonaceous nanomaterials [Evans et al.

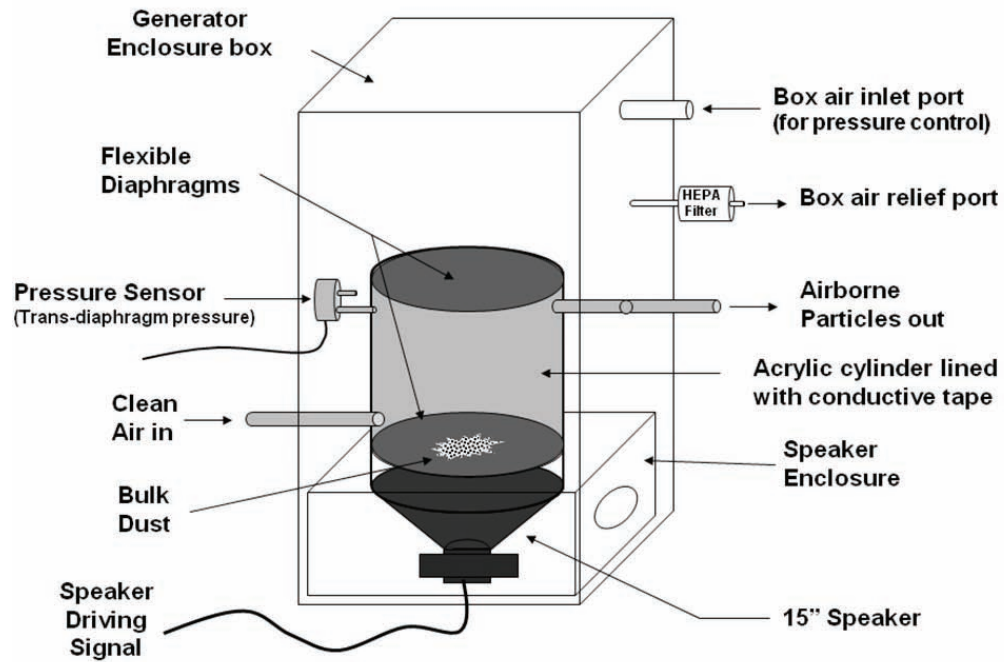

Figure 6. The multi-walled carbon nanotube aerosol generator.

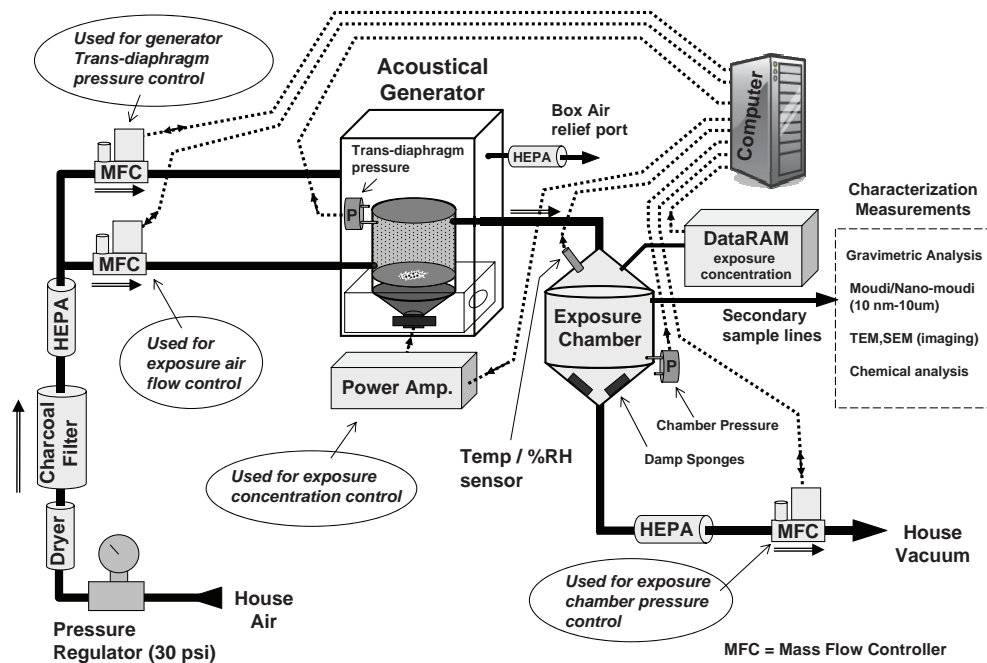
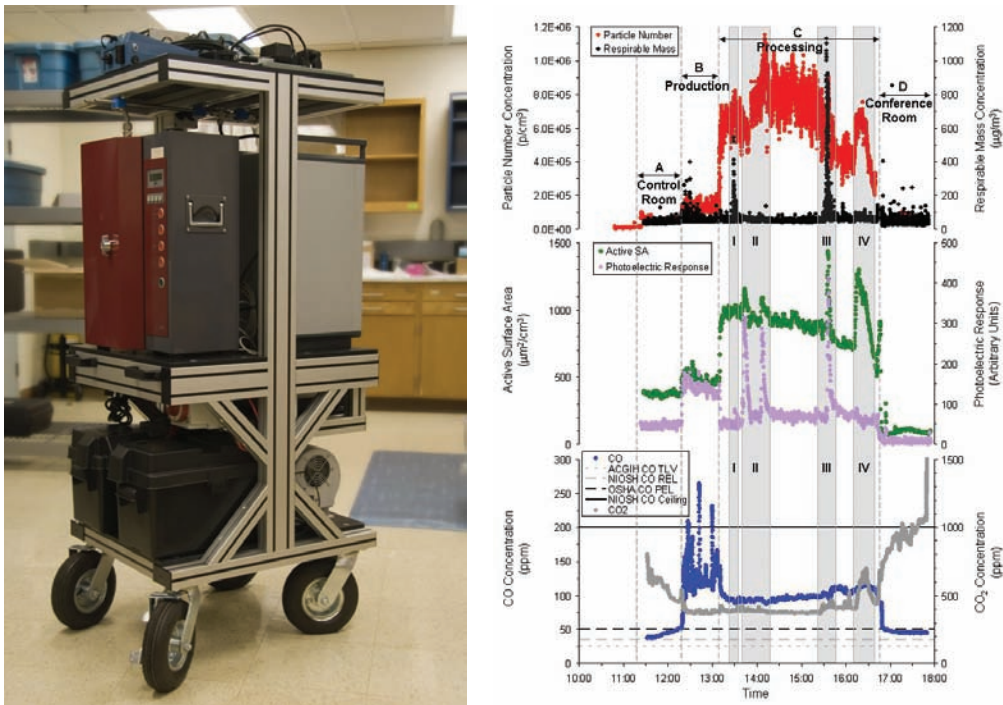

Figure 7. The nanomaterial exposure system interface.



**Figure 8.** Particle instrument array and time series of particle metrics used in the Evans et al. [2010] CNF workplace study.

2010; Birch et al. 2011; Birch 2011]. For example, in the draft 2010 NIOSH Current Intelligence Bulletin (CIB) *Occupational Exposure to Carbon Nanotubes and Nanofibers*, a modified NIOSH sampling and analytical method (NMAM 5040 for CNTs/CNFs) was recommended to provide the means for quantifying occupational exposures to CNTs and CNFs. This modified method is currently in use for an ongoing NIOSH industry-wide study of workers exposed to CNTs and CNFs [Dahm et al. 2011].

NTRC researchers are also collaborating with the National Institute of Standards and Technology (NIST) and National Research Council Canada to identify and develop nanoscale reference materials (RMs) for use in calibrating and evaluating measurement instruments and for toxicology studies. NIOSH provided technical input and aided in the organization of the interlaboratory study for a titanium dioxide RM, NIST SRM 1898: Titanium Dioxide Nanopowder. Current efforts focus on qualifying nanocrystalline cellulose (powder and suspension) and SWCNTs as RMs.

### 2.2.1 Development of Innovative Technologies

NTRC researchers have pioneered the development of new sampling equipment to measure nanomaterials. NTRC researchers developed a hand-held electrostatic precipitator (ESP) particle sampler that permits the collection of airborne nanoparticles onto a sample grid that can be directly used for electron microscopy (EM) analysis. The hand-held ESP eliminates the need for a conventional pump-and-filter to collect airborne nanoparticle samples and provides the ability to quickly assess multiple processes and





areas. This sample collection method also reduces the time needed to prepare samples for EM analysis. The prototype (developed by NIOSH in 2004–2007) was subsequently licensed to a commercial supplier, Dash Connector Technology, Inc., which is marketing the instrument for aerosol and industrial hygiene sampling (Figures 9 and 10).

Two additional nanomaterial sampling instruments have been developed by NTRC researchers: a Portable Aerosol Mobility Spectrometer (PAMS) and a Personal Nano-aerosol Sizer (PNS). Both instruments can continuously measure and record (in near-real-time) particle number, surface area, and mass concentrations of nanoparticle and ultrafine aerosols in the workplace. PAMS is a handheld instrument that uses a condensation particle counter as a detector and allows reliable measurement of aerosols over a wide nanoparticle size range. PNS is a low-cost, robust personal sampler that allows the measurement of personal exposures to nanoaerosols. These instruments are expected to be valuable tools for workplace nanoaerosol exposure measurements. A prototype of PAMS has been successfully developed in collaboration with Kanomax, USA, Inc. (Figure 11). A prototype of PNS has been designed and fabricated, and its performance is being evaluated.

NTRC researchers are continuing to evaluate measurement methods and technologies and conducting research to link the measurements to toxicologic data and health end points.

### 2.3 Exposure Assessment

Workplace exposure assessments are vital to developing accurate risk characterizations of exposure of workers to engineered nanomaterials. The NTRC has direct responsibility for conducting exposure assessments at nanomaterial production and user facilities to support epidemiologic and control research, as well as the development of comprehensive risk management guidance. Since 2006, NTRC researchers have conducted over 40 workplace investigations at research facilities, pilot plants, and manufacturing sites that are actively making or using engineered nanomaterials. This research effort has been one of the most productive activities of the NTRC

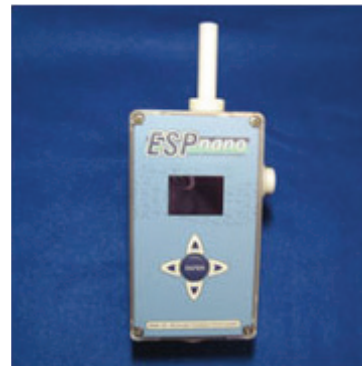

Particle Characterization

**Figures 9 and 10.** Hand-held electrostatic precipitator developed by NIOSH researchers and licensed to Dash Connector Technology, Inc.



**Figure 11.** Portable Aerosol Mobility Spectrometer (PAMS) developed in collaboration with Kanomax, USA, Inc.

because of the success of engaging the private sector as partners. From these efforts, NIOSH has developed partnerships with large and small nanomaterial manufacturing companies and has gained invaluable insight on how nanomaterials are being handled. This activity has also resulted in formal agreements with other government agencies and several major nanotechnology research centers and business consortia for conducting workplace exposure assessments. Three companies that have voluntarily received site evaluations from NTRC researchers were interviewed by Nanowerk, LLC, for its August/September 2007 issue of *Nanorisk* ([www.nanorisk.org/](http://www.nanorisk.org/)). Overall, the companies described the collaborations as beneficial and encouraged other companies to take advantage of NIOSH's expertise, services, instrumentation, and objective assessments. At the 2010 Nanomanufacturing Summit, sponsored by the NanoBusiness Commercialization Association, four companies publically described their experience with NTRC researchers as being extremely helpful in providing guidance on the safe handling of engineered nanomaterials. One of those companies, NanoComp Technologies, Inc., listed NIOSH as a key partner in developing an effective environmental health and safety (EHS) program that supported the growth of its company (M. Banash, 2010 presentation: *Managing NanoEHS: Moving from the Lab to the Plant*).



The most recent demonstration of the effectiveness of NIOSH partnerships comes in a study of NNI EHS by the Government Accountability Office [GAO 2012]. The GAO made inquiries of seven select NNI agencies engaged in EHS research on the extent to which they collaborate with each other and with external partners. The intent of the inquiry was to evaluate the effectiveness of the collaborations. GAO surveyed 100 private sector stakeholders and found that the stakeholders placed greatest value in partnerships with NIOSH, over other NNI agencies (Figure 12). In the same inquiry, the GAO asked how often these same stakeholders went to one of the NNI agencies for information, and which agency. Among those who indicated they went to agency sources “often,” NIOSH was identified as the lead agency.

Workplace exposure assessment studies conducted by NTRC researchers have provided 1) identification of the types of nanomaterials being considered for commercialization, 2) information on the potential for worker exposure associated with the processes that manufacture or use those materials, and 3) the basis for risk management guidance. Early investigations have identified nanomaterial processes and tasks

Usefulness of collaborative EHS research or related activities with NNI member agencies, according to GAO questionnaire respondents

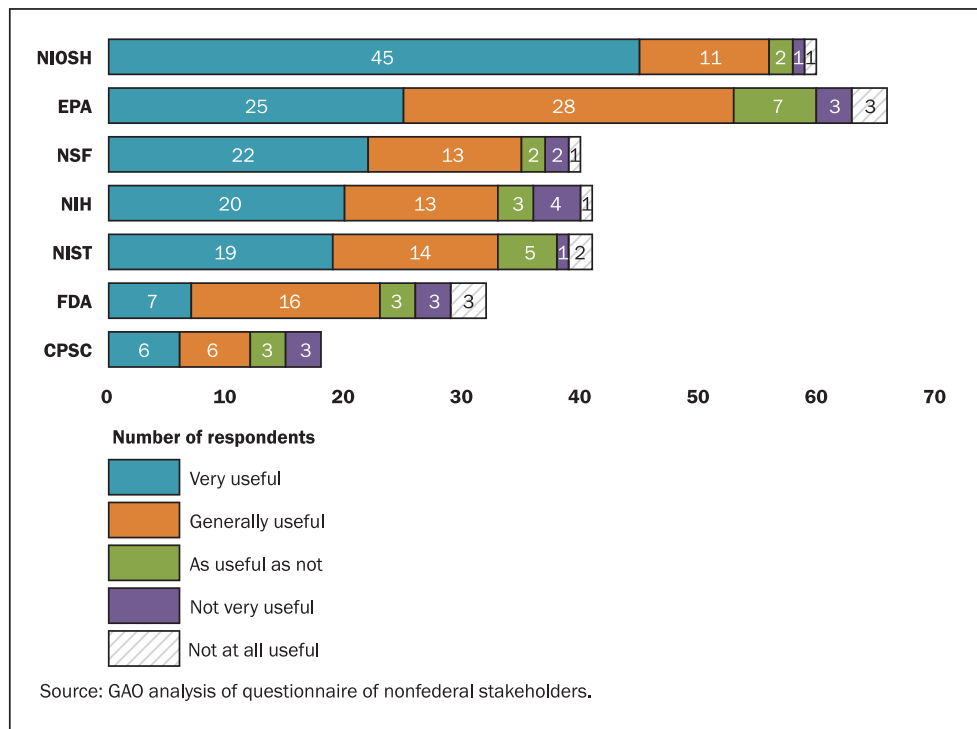

Note: Excludes respondents who selected “No basis to judge” and those who did not check a response.

Figure 12. Summary of the GAO questionnaire on the usefulness of collaborative studies with select Federal agencies working on EHS [GAO 2012].

that were good candidates for detailed follow-up studies to evaluate the effectiveness of in-place exposure control measures (e.g., engineering controls). Recommendations by NTRC researchers on the effective use of exposure controls have resulted in companies adopting improved engineering controls, including local exhaust ventilation (LEV) [Methner and Old (Ed.) 2008, Methner 2010, Evans et al. 2010]. For example:

1. Recommendations from NTRC researchers to a graphene manufacturer resulted in the company taking the following steps to reduce exposures:
  - running the spray dryer ventilation system while scraping out the inside of the spray dryer during equipment cleaning.
  - delaying the product harvest of graphene for at least 15 minutes after process completion to reduce the potential for emissions and worker exposure.
2. Birch et al. [2011] reported respirable elemental carbon concentrations (area samples) inside a nanofiber manufacturing facility that were about 6–68 times higher than outdoors, whereas personal breathing zone samples were up to 170 times higher. Elevated particle number concentrations and high concentrations of carbon monoxide (CO) were also identified at the same facility [Evans et al. 2010]. The report to these companies included recommended engineering control measures for reducing the exposures.
3. In the industrywide exposure assessment study of primary and secondary manufacturers of CNT and CNF, Dahm et al. [2011] identified short-term peak exposures to CNTs and CNFs at various job tasks and processes. Various risk management practices (e.g., engineering controls) were recommended to assist in preventing worker exposure.

By 2011, findings from the NTRC exposure investigations at various workplaces handling engineered nanomaterials (Figures 13–16) had yielded the knowledge and experience needed to conduct more comprehensive exposure assessment studies to quantitate workers' exposure. The findings from these studies supported the initiation of a health effects study of workers exposed to carbonaceous nanomaterials (primarily CNTs and CNFs) and the initiation of studies to evaluate the effectiveness of engineering controls to reduce worker exposure. These research activities will build upon existing partnerships and forge new partnerships to accomplish objectives. Outcomes from this research are expected to provide additional guidance on the safe handling of these materials during commercial application.

## 2.4 Epidemiology and Surveillance

In 2009, NIOSH published the *CIB 60: Interim Guidance for Medical Screening and Hazard Surveillance for Workers Potentially Exposed to Engineered Nanoparticles* [www.cdc.gov/niosh/docs/2009-116/], which provided the first (interim) guidance on medical surveillance and medical screening for workers potentially exposed to engineered nanoparticles [NIOSH 2009c]. To address gaps in information needed to implement an effective occupational health surveillance program for nanotechnology workers, NIOSH and the University of Colorado Mountain and Plains Education and Research Center (ERC) organized the 2010 workshop *Nanomaterials and Worker Health: Medical Surveillance, Exposure Registries, and*





**Figures 13–16.** Nanomaterial workers participating in the NTRC field research efforts.

*Epidemiologic Research.* The workshop was convened to catalyze the thinking behind the research necessary to support human health studies needed to more completely characterize potential health risks. The proceedings from this workshop were subsequently published in a June 2011 supplemental issue of the *Journal of Occupational and Environmental Medicine* [Schulte, Trout, and Hodson 2011] (Figure 17). In 2010, NIOSH drafted the *CIB Occupational Exposure to Carbon Nanotubes and Nanofibers*, which includes recommendations for medical surveillance and screening specific for workers potentially exposed to these materials.

In 2008, NTRC researchers undertook a pilot study to determine whether the conduct of an epidemiological or other health study of workers exposed to carbonaceous nanomaterials was feasible [Schubauer-Bergian et al. 2011]. The initial steps of the study involved identifying potentially eligible U.S. companies producing engineered carbonaceous materials, to determine workforce size, location, and estimated growth. Companies were contacted by telephone and a questionnaire was administered to confirm the use of carbonaceous materials and their interest in participating in the study. A total of 35 U.S. manufacturers and users of carbonaceous nanomaterials completed the survey. Follow-up site visits to 16 of the facilities was conducted to confirm workforce size, location, characteristics of the nanomaterials produced, and whether the reported use of engineering controls and personal protective equipment was accurate (Table 1).

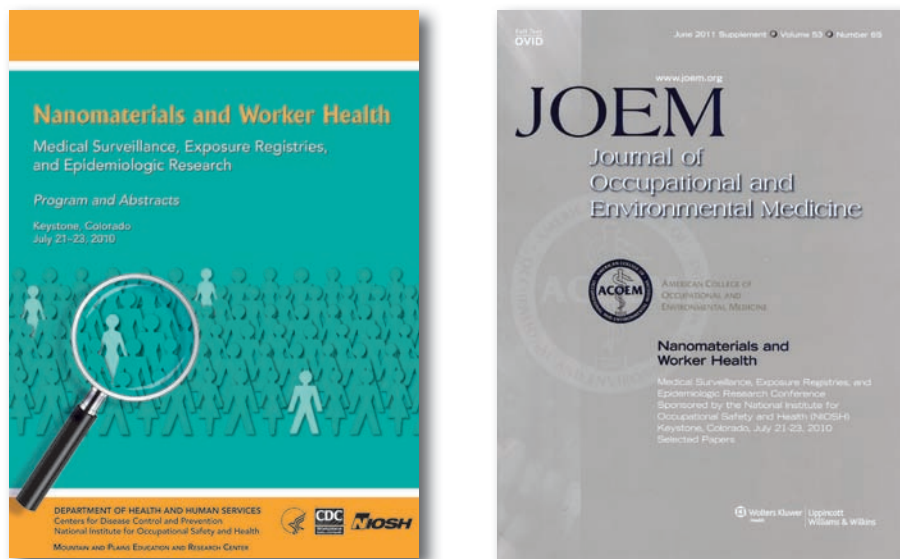

**Figure 17.** The 2010 Nanomaterials and Worker Health conference resulted in a 2011 supplemental issue of the Journal of Occupational and Environmental Medicine dedicated to nanomaterials and worker health, medical surveillance, exposure registries, and epidemiologic health.

**Table 1. Statistics on use of administrative and engineering controls, as well as personal protective equipment, in the carbonaceous nanomaterials industry in the United States**

Variable	NIOSH survey result (2008–2011)*	Concordance of field observations with survey reports	
		Observed exactly as reported	Observed as reported or better
Total N	35	16	16
Wet-wipe cleanup methods	22 (63%)	69%	94%
Use of HEPA vacuum for cleanup	18 (51%)	94%	94%
Lab coats/Tyvek suits	29 (83%)	88%	94%
Gloves	33 (94%)	94%	100%
Respirators	28 (80%)	81%	100%
Local exhaust ventilation	25 (71%)	88%	88%
Chemical fume hoods	29 (83%)	75%	75%
Ventilated enclosures	14 (40%)	75%	88%
Glove boxes	14 (40%)	81%	88%
Enclosed production	12 (34%)	63%	88%

\*Among sites surveyed by NTRC researchers. Includes producers and users of engineered carbonaceous nanomaterials.



The follow-up site visits also included assessments of exposure to CNTs and CNFs, as described in Section 2.3 and reported by Dahm et al. [2011]. These assessments led to the recognition that the conduct of an epidemiologic study of workers potentially exposed to CNTs and CNFs was feasible. Therefore, NIOSH researchers in FY12 developed a draft protocol to conduct a cross-sectional epidemiologic study among 100 workers at facilities manufacturing or using CNTs or CNFs. This protocol focuses on identifying early markers of pulmonary or cardiovascular health effects, together with the collection of worker CNT and CNF personal exposure data.

The NIOSH survey of companies handling CNT and CNFs found that 70% reported having a health and safety program for the use of nanomaterials [Dahm et al. 2011]. The supplemented survey data (n = 35) show that 83% of the companies reported using chemical fume hoods, 71% reported using local exhaust ventilation, 40% reported using ventilated enclosures or gloveboxes, 34% were using enclosed production processes, and more than 80% were using each type of PPE (Table 1). NIOSH subsequently visited 16 of the 35 companies responding to the survey. On-site evaluation confirmed that nearly all companies visited used administrative and engineering controls and PPE as reported or more stringently than reported (Table 1). More than 90% of the CNT and CNF companies used all PPE types, wet-wipe cleanup methods, and HEPA vacuums, as reported in the survey or better. At least 75% were using engineering controls as reported in the survey or better.

NIOSH also conducted field investigations between 2006 and 2012 in 46 facilities (including the 16 handling CNT and CNFs) handling other types of nanomaterials. These field evaluation reports and field notes were evaluated to assess the level of adherence with risk management principles within the participating companies. Since 16 of the ECN facilities participating in the survey were also part of the 46 field evaluations, this created the opportunity to assess the accuracy of self-reported administrative and engineering control and PPE use. Of the 46 companies visited for a field evaluation, PPE use was observed somewhat more frequently than administrative and engineering control use: 89% used some form of PPE and 83% used a hood or other enclosure for at least some processes. Of the 46 companies evaluated, 54% used chemical fume hoods, 59% used local exhaust ventilation, 50% used ventilated enclosures or gloveboxes, 48% used enclosed production processes, and 78% used respiratory protection (Figure 18).

## 2.5 Risk Assessment

NTRC researchers continue to investigate how exposure-response data (human or animal) for fine and ultrafine particles can be used to quantitate the risk of exposure for workers. NTRC researchers conducted a risk assessment on the pulmonary effects seen in experimental animal studies following exposure to fine and ultrafine TiO<sub>2</sub>, CNTs, and CNFs. The results of these assessments supported the development of NIOSH recommended exposure limits (RELs) for ultrafine TiO<sub>2</sub>, CNTs, and CNFs. These are the first occupational exposure limits for these classes of nanomaterials issued by a U.S. government agency.

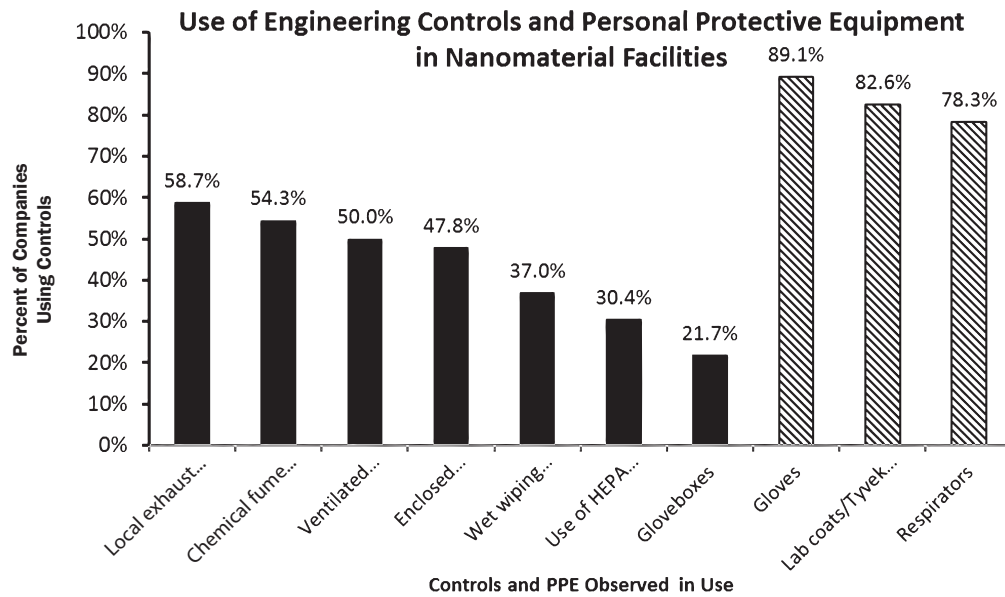

**Figure 18.** A summary of the use of engineering controls and PPE use in 46 nanomaterial facilities visited by NTRC researchers.

NTRC risk assessors continue to collaborate with the following researchers in the development of particle dosimetry models and risk assessment techniques for nanomaterials:

- Institute of Occupational Medicine (IOM), Edinburgh, UK, and EU 7th Framework Program on Risk Assessment of Engineered Nanoparticles (ENPRA)
- Toxicology Excellence for Risk Assessment (TERA)
- Applied Research Associates (ARA), Raleigh, NC
- Lovelace Respiratory Research Institute (LRRI), Albuquerque, NM
- The Hamner Institutes for Health Sciences, Research Triangle Park, NC

These collaborations have resulted in 1) the completion of an olfactory deposition model of spherical nanoparticles in humans and in rats (Hamner Institute/NIOSH research collaboration), 2) modeling methods to predict human respiratory tract deposition for carbon nanofiber/nanotube structures, based on fiber aerosol theory (Hamner Institute and ARA/NIOSH research collaboration), and 3) experiments to characterize deposition of airborne CNTs in a human respiratory tract replica. Data from this later study are being used in the human lung deposition model for carbon nanotubes/nanofibers that is being developed by ARA (LRRI/NIOSH collaboration).



Because of the lack of hazard data on each type of engineered nanomaterial, NTRC researchers are investigating the utility of risk assessment methods that can be applied to categories of nanomaterials (Figure 19).

NTRC researchers also participate in the Organization for Economic Cooperation and Development (OECD) Steering Group 6 (SG6) to develop guidance on critical issues in nanotechnology risk assessment.

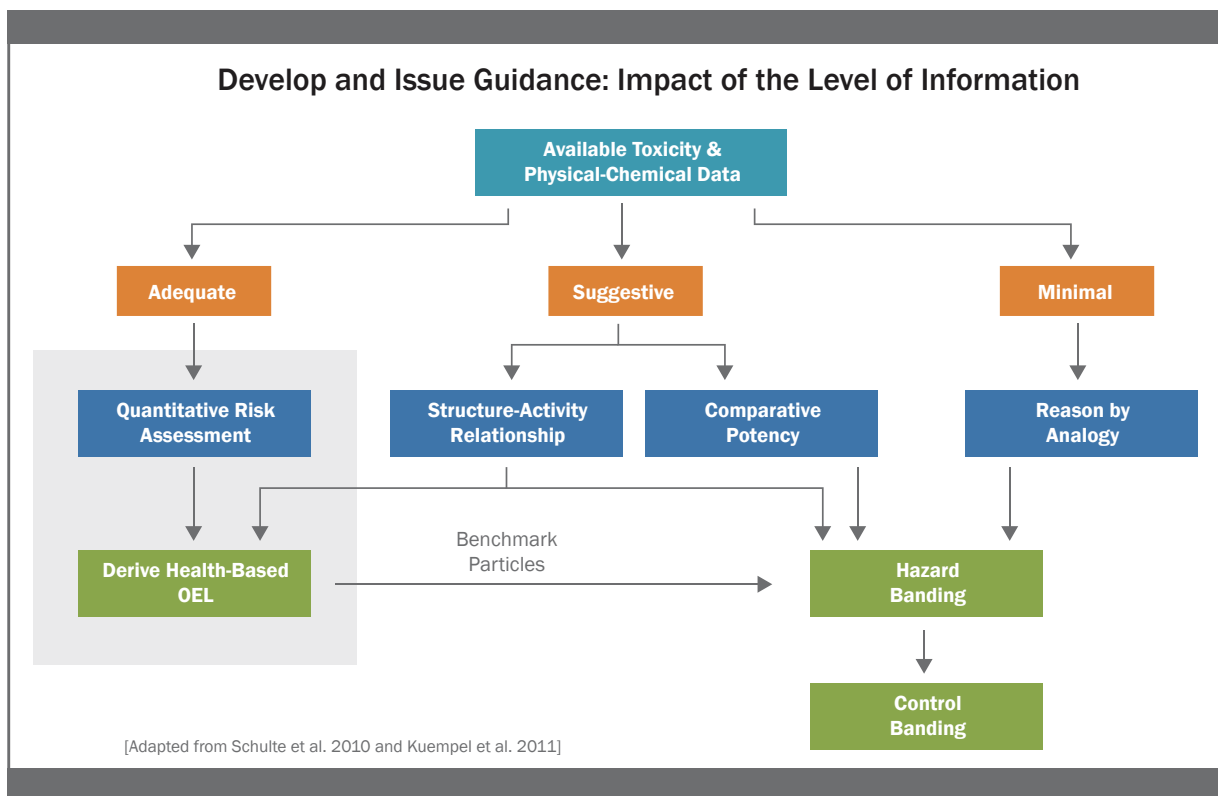

**Figure 19.** Steps to developing occupational exposure limits or control bands, according to availability of toxicologic data.

## 2.6 Engineering Controls and Personal Protective Equipment

Given the uncertainty about the hazard potential of many nanomaterials, there remains the need for information on engineering controls and PPE. NTRC researchers are investigating the effectiveness of various engineering control techniques and PPE in preventing worker exposure to engineered nanoparticles (Figure 20). Results from NTRC field activities (described in 2.3 Exposure Assessment) conducted to assess engineering control measures have been published in the following NIOSH workplace survey reports and peer-reviewed literature:





**Figure 20.** Local exhaust ventilation and PPE used during reactor cleanout.

- Methner MM, Old L (Ed.) [2008]. Engineering case study: effectiveness of local exhaust ventilation in controlling engineered nanomaterial emissions during reactor cleanout operations. *J Occup Environ Hyg* 5(6):D63–D69.
- Methner MM [2010]. Effectiveness of a custom-fitted flange and LEV system in controlling the release of nano-scale metal oxide particulate. *Intl J Occup Environ Health* 16:475–487.
- Evans DE, Ku Ki B, Birch ME, Dunn KH [2010]. Aerosol monitoring during carbon nanofiber production: mobile direct-reading sampling. *Ann Occup Hyg* 54(5):514–531.
- Lo LM, Dunn KH, Hammond D, Almaguer D, Bartholomew I, Topmiller J, Tsai CSJ, Ellenbecker M, Huang CC [2011]. Evaluation of engineering controls for manufacturing nanofiber sheets and yarns. Cincinnati, OH: U.S. Department of Health and Human Services, Centers for Disease Control and Prevention, National Institute for Occupational Safety and Health, DHHS (NIOSH) Report No. EPHB 356–11a.



- NIOSH [2012]. General safe practices for working with engineered nanomaterials in research laboratories. Cincinnati, Ohio: U.S. Department of Health and Human Services, Centers for Disease Control and Prevention, National Institute for Occupational Safety and Health, Publication No. 2012-147 (Figure 21).
- A NIOSH draft document on engineering control guidance for nanomaterial manufacturers and users, entitled *Current Strategies for Engineering Controls in Nanomaterial Handling Processes*, is scheduled for publication in late 2012.

NTRC researchers have evaluated and published the results on the effectiveness of respiratory protection for capturing nanoparticles, as well as created an information blog on the NIOSH Web page [<http://blogs.cdc.gov/niosh-science-blog/category/respiratory-health/>].

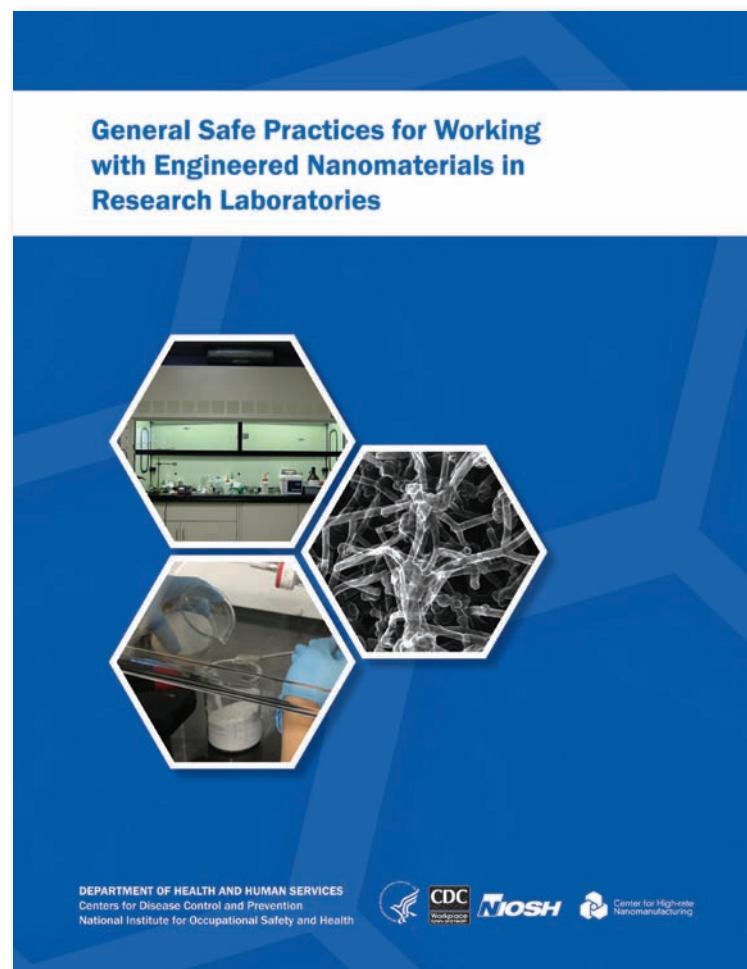

**Figure 21.** The cover of the NIOSH guidance document detailing best practices for working with engineered nanomaterials in research laboratories.

Respirator performance studies conducted by NTRC researchers have shown that NIOSH-approved respirators should provide levels of performance consistent with their assigned protection factors [Rengasamy et al. 2008; Shaffer and Rengasamy 2009; Rengasamy and Eimer 2011; Rengasamy and Eimer 2012].

Research with other types of PPE (gloves and clothing) is ongoing (Figure 22). NTRC researchers developed and evaluated a multidomain magnetic passive aerosol sampler for measuring particulate penetration through protective ensembles. The design of this sampler was submitted as an employee invention to the CDC Technology Transfer Office (Ref. #I-007-08). This new sampler significantly enhances collection of magnetically susceptible particles, better simulates the user's real situation in the workplace than alternative filtration-based approaches, and improves the capability for determining particle penetration through protective clothing materials. Results from a study evaluating the penetration of nanoparticle and submicron particle penetration through different fabrics show that particle penetration increased with increasing face velocity and also increased with increasing particle size up to about 300 to 500 nm [Gao et al. 2011]. Penetrations measured by the wind-driven method were lower than those obtained with the filtration method for most of the fabrics selected, and the relative penetration performances were very different because of the vastly different pore structures of the fabric.

## 2.7 Fire and Explosion Safety

Research is ongoing into the physical and chemical properties that contribute to dustiness, combustibility, flammability, and conductivity of nanomaterials. Explosion testing was performed on 20 types of carbonaceous particles, including SWCNTs, MWCNTs, CNFs, graphene, diamonds, fullerene, and carbon black graphite. The typical overpressure and deflagration indexes were observed to be similar to those of cotton or wood dust. The explosion parameters did not appear to correlate with particle size. For selected materials, explosion testing was conducted at scans of dust concentration, which



**Figure 22.** (Left) An improperly connected glove and garment. (Right) A properly connected glove and coverall do not permit the nanomaterials to touch (reach) the skin.





yielded low minimum explosive concentrations (at the low end of the range typically observed for coals) which could be of concern for workers. Scans of ignition energy proved inconclusive due to electrical shorting of the equipment by the conductive powders.

Research results on dustiness, flammability, and explosibility of nanomaterials have been presented at numerous meetings and conferences. A publication on the dustiness of 27 fine and nanoscale powders, tested with a device developed for pharmaceutical application, is in progress.

## 2.8 Recommendations and Guidance

While in the early stages of understanding the health risks associated with exposure to engineered nanoparticles, NTRC researchers developed the first comprehensive compendium of guidance to inform employers of the potential hazards of nanomaterials and the steps that could be taken to help minimize the health risks from exposure. The document *Approaches to Safe Nanotechnology: An Information Exchange with NIOSH* was first posted on the NIOSH Web site in 2005 and became one of the most widely utilized nanomaterial occupational safety and health guidance documents throughout the world. Recommendations given in the document have provided the rationale and basis for guidance documents developed by the Organization for Economic Cooperation and Development (OECD), the International Standards Organization (ISO), National Institute of Occupational Safety and Health Japan, and Safe Work Australia. The OECD recommendations on exposure measurement and mitigation were tailored after the NIOSH recommendations provided in *Approaches to Safe Nanotechnology*. This OECD guidance document is used by nearly every industrialized country in the world. ISO Standard 12885, entitled *Nanotechnologies: Health and Safety Practices in Occupational Settings Relevant to Nanotechnologies*, also was based on the NIOSH compendium. In 2009, the NIOSH document was updated and released as *Approaches to Safe Nanotechnology: Managing the Health and Safety Concerns Associated with Engineered Nanomaterials* [[www.cdc.gov/niosh/docs/2009-125/](http://www.cdc.gov/niosh/docs/2009-125/)] [NIOSH 2009b]. This document continues to be one of the most widely used and cited occupational risk management frameworks for nanomaterials in the United States. The document has been downloaded from the NIOSH Web site over 11,000 times (Table 2).

An abbreviated companion brochure, *Safe Nanotechnology in the Workplace: An Introduction for Employers, Managers, and Safety and Health Professionals*, was developed to highlight the uncertainty about the health risks of nanomaterials and the need to take precautionary actions to control workplace exposures. Approximately 45,000 copies of the brochure have been distributed in both English and Spanish. Other countries have translated the brochure into Italian, Portuguese, and Japanese.

In 2005, NIOSH posted on the Web for public comment a draft of the world's first recommended exposure limit (REL) specifically for a nanomaterial, by issuing guidance for nanosized TiO<sub>2</sub> in addition to micrometer-sized TiO<sub>2</sub> (bulk fine pigment). Even as a draft, this pioneering document was widely cited. *CIB 63: Occupational Exposure to Titanium Dioxide* [[www.cdc.gov/niosh/docs/2011-160/](http://www.cdc.gov/niosh/docs/2011-160/)] was finalized and disseminated in early 2011 [NIOSH 2011].

**Table 2. Dissemination of NIOSH NTRC nanotechnology guidance documents between 2004 and 2011**

Publication	Number printed	Number disseminated	Number of Web site downloads
NIOSH Pub No. 2004-175 Nanotechnology Workplace Safety and Health	1,099	1,099	1,750
NIOSH Pub No. 2008-112 Safe Nanotechnology in the Workplace: An Introduction for Employers, Managers, and Safety and Health Professionals (English)	36,000	29,055	1,987
NIOSH Pub No. 2008-112 Safe Nanotechnology in the Workplace: An Introduction for Employers, Managers, and Safety and Health Professionals (Spanish)	17,000	15,485	N/A
NIOSH Pub No. 2008-121 NIOSH Field Research Effort Fact Sheet	5,000	2,067	556
NIOSH Pub No. 2009-116 CIB 60. Interim Guidelines for Medical Screening and Hazard Surveillance for Workers Potentially Exposed to Engineered Nanoparticles	3,000	1,338	2,551
NIOSH Pub No. 2009-125 Approaches to Safe Nanotechnology: Managing the Health and Safety Concerns Associated with Engineered Nanomaterials	7,850	2,528	11,487

In 2010, NIOSH drafted another CIB, *Occupational Exposure to Carbon Nanotubes and Nanofibers*. This CIB includes a REL for CNTs and CNFs, as well as comprehensive risk management recommendations for medical surveillance and monitoring, exposure monitoring, and procedures for controlling workplace exposure. Many of the risk management recommendations are derived from field and laboratory findings of NTRC researchers.

NTRC researchers have provided a broad range of guidance on topics ranging from medical surveillance, epidemiologic research, precautionary approaches, occupational exposure limits, active nanomaterials, and governance [Schulte and Salamanca-Buentello 2007; Murashov and Howard 2008; Schulte et al. 2008; Schulte et al. 2009; Howard and Murashov 2009; Schulte et al. 2010; Schulte, Trout, and Hodson 2011; Schulte et al. 2012].



## Highlights of NIOSH Recommendation Activities

1

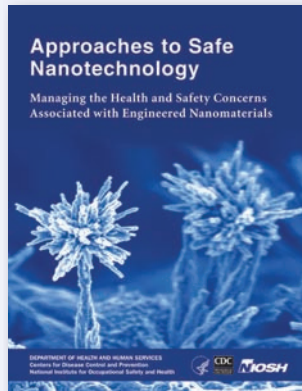

2

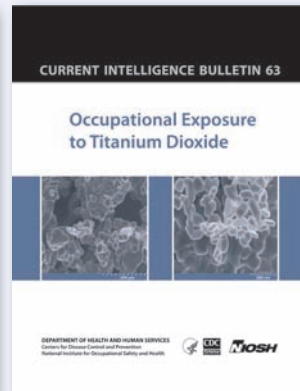

3

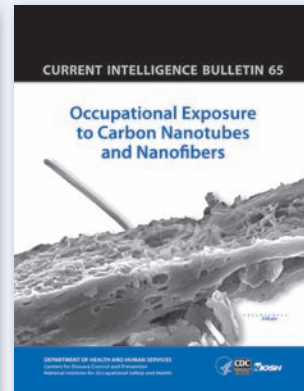

1. *Approaches to Safe Nanotechnology: Managing the Health and Safety Concerns Associated with Engineered Nanomaterials* continues to be one of the most widely used and cited occupational risk management frameworks for nanomaterials.
2. NIOSH is the first agency globally to conduct the scientific research and assessments necessary to issue recommended exposure limits specifically for an engineered nanomaterial (titanium dioxide). Even as a draft, this pioneering document was widely cited. It was published in 2011.
3. NIOSH issued a draft CIB *Occupational Exposure to Carbon Nanotubes and Carbon Nanofibers* in 2010.

## 2.9 Communications and Information

Communicating the results of ongoing research activities is an important objective of the NTRC. Since the inception of the nanotechnology research program in 2004, researchers have delivered over 650 invited presentations, including over 100 internationally, at scientific meetings, symposia, and workshops (Figure 23). NTRC staff members have also conducted workshops and training sessions on effective risk management practices for handling nanomaterials in the workplace (Appendix A). The dissemination of research findings and risk management recommendations resulted in early recognition for NIOSH as a key contributor in the development of the national environmental health and safety research strategy prepared by the U.S. National Nanotechnology Initiative (NNI). Clayton Teague, director of the National Nanotechnology Coordination Office (NNCO), recognized NIOSH at the June 25, 2008, TAPPI International Conference on Nanotechnology for the Forest Products Industry for its initiative in recommending a national occupational

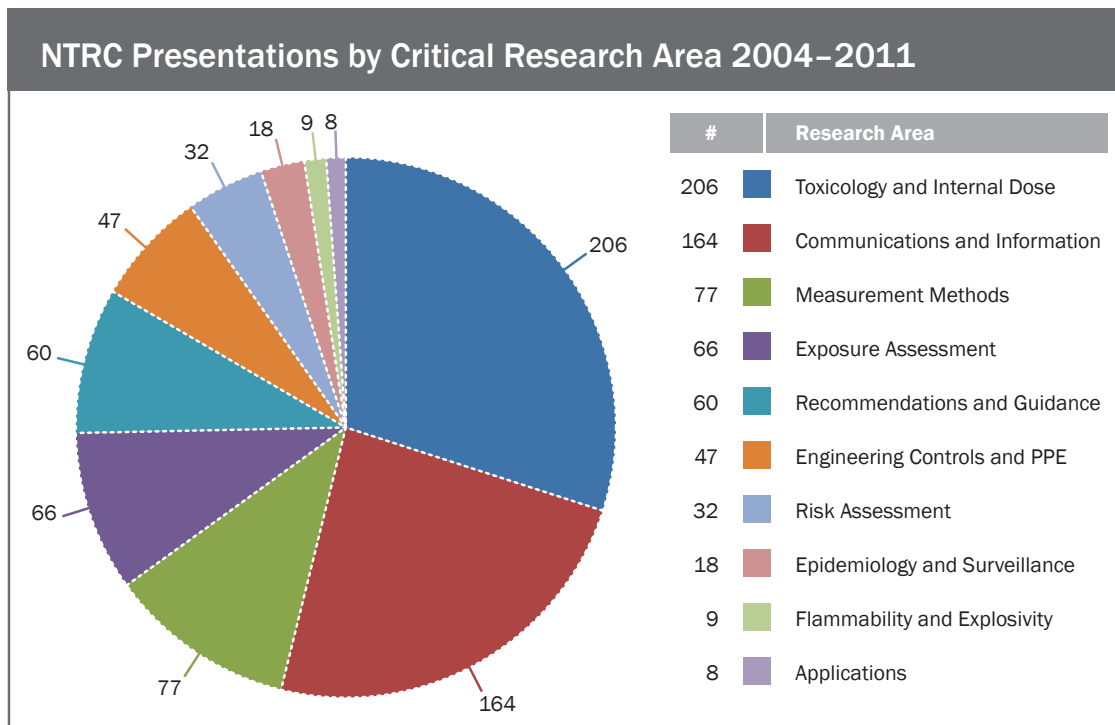

**Figure 23.** Distribution of presentations by critical research area.

health and safety research strategy. The NNCO also cited NIOSH's success in developing partnerships with private companies to assist with responsible development of nanotechnology. This acknowledgement is noteworthy because the NNCO serves as a central point of contact for Federal nanotechnology R&D activities and provides public outreach on behalf of the NNI. The NNCO coordinates the preparation and publication of NNI inter-agency planning, budget, and assessment documents, such as the annual NNI supplement to the President's budget. In addition, the NNCO coordinates development of information for the NNI and its activities for Congress when requested.

NIOSH has sponsored and co-sponsored many nanomaterial workshops at which representatives from academia, labor, industry, and health and safety have collaborated. The substantive input by NTRC researchers on the interpretation of research results, identification of research gaps (toxicology, exposure characterization), and recommendations on good risk-management practices are frequently used in developing the conclusions and recommendations contained in the workshop proceedings.



## NIOSH–Sponsored or –Co-Sponsored Workshops and Conferences on Engineered Nanomaterials

- First Symposium on Occupational Health Implications of Nanomaterials, Buxton, United Kingdom (2004)
- Second Symposium on Occupational Health Implications of Nanomaterials, Minneapolis, MN (2005)
- International Conference on Nanotechnology Occupational and Environmental Health and Safety: Research to Practice; Cincinnati, OH (2006)
- First International Conference on Nanotoxicology, Miami, FL (2006)
- In collaboration with the International Aerosol Research Assembly and the American Association for Aerosol Research: Second International Symposium on Nanotechnology and Occupational Health, in conjunction with International Aerosol Conference, St. Paul, MN (2007)
- Third Symposium on Occupational Health Implications of Nanomaterials, Taipei, Taiwan (2007)
- In collaboration with government, academia, labor, and industry, workshop to review a draft document developed by NIOSH and a cross-agency workgroup, *Interim Guidelines on Medical Screening of Workers Potentially Exposed to Engineered Nanoparticles*, in Washington, DC (2008)
- In collaboration with the National Institute of Standards and Technology, *Enabling Standards for Nanomaterial Characterization* (workshop), in Gaithersburg, MD (2009)
- Second International Conference on Nanotechnology, Zurich, Switzerland (2009)
- In collaboration with OECD, *Exposure Assessment and Exposure Mitigation* workshop, Frankfurt (2009) and Karlsruhe (2010), Germany
- As lead organizer, NNI Workshop on Human and Environmental Exposure, Bethesda, MD (2009)
- Fourth International Conference on Nanotechnology—Occupational and Environmental Health, Helsinki, Finland (2009)
- As lead organizer, *Nanomaterials and Worker Health: Exposure Registries, Medical Surveillance and Epidemiologic Research*, Keystone, CO (2010)
- Fifth International Conference on Nanotechnology—Occupational and Environmental Health, Boston, MA (2011)
- Workshop on Global Harmonization of Exposure Measurements, Boston, MA (2011)
- *Safe Nano Design: Molecule » Manufacturing » Market: Applying Prevention through Design to Nanomaterials*, with the College of Nanoscale Science & Engineering (CNSE), University at Albany, State University of New York, Albany, NY (2012)



### 2.9.1 NIOSH Nanotechnology Web Site

In 2005, NIOSH created the first nanotechnology topic page on the NIOSH Web site devoted to providing information on the potential hazards of engineered nanomaterials in the workplace (Figure 24). The Web site provides a one-stop source of scientific and technical information intended to help guide the public and safety and health professionals in making good risk management decisions. Since its inception in 2005, the topic page on the NIOSH Web site has evolved into a comprehensive source that contains links to all of the NIOSH nanotechnology guidance documents, abstracts of published articles, nanotechnology health and safety news updates, and links to other sources of nanotechnology information. In 2011, individuals from 139 countries visited the NIOSH nanotechnology topic page on the Web site; the United States accounted for 61% of the total visits, and other countries accounted for the remaining 39% (Table 3). The topic page on the Web site receives over 2,000 visits each month (Figure 25).

### 2.9.2 Bibliometric Analysis

When NIOSH published its first progress report, *Progress Toward Safe Nanotechnology in the Workplace* in 2007, NTRC researchers had already published more than 70 articles in the peer-reviewed scientific literature (Figure 26). This number had increased to over 170 with the publication of the second progress report in 2009. These publications included results from some of the first scientific studies demonstrating that

The screenshot shows the NIOSH Nanotechnology Topic Page. At the top, there is a search bar and navigation links. The main content area is titled "NANOTECHNOLOGY" and includes an "Overview" section with text about nanotechnology, a "Spotlights" section with links to new study links and safe practices, and a "Contact Us" section with phone and email information. A sidebar on the left contains a navigation menu with categories like "Workplace Safety and Health Topics", "Industries & Occupations", and "Nanotechnology". A sidebar on the right offers options like "Email page link", "Print page", and "Subscribe to RSS".

Figure 24. Screen shot of the NIOSH Nanotechnology Topic Page.



**Table 3. The top 20 countries accounting for visitors to the NIOSH Nanotechnology Topic Page in 2011.**

Countries	Page views	
1. United States	23,437	60.8%
2. Canada	1,432	3.7%
3. United Kingdom	1,084	2.8%
4. France	937	2.4%
5. India	821	2.1%
6. Japan	745	1.9%
7. Australia	674	1.7%
8. Italy	621	1.6%
9. Spain	534	1.4%
10. Iran (Islamic Republic of)	528	1.4%
11. Brazil	487	1.3%
12. Germany	479	1.2%
13. Malaysia	401	1.0%
14. Korea-South	371	1.0%
15. China	305	0.8%
16. Singapore	271	0.7%
17. Netherlands	256	0.7%
18. Switzerland	241	0.6%
19. Taiwan	241	0.6%
20. Belgium	237	0.6%

### Number of visitors to the NIOSH Nanotechnology Topic Page (2009–2011)

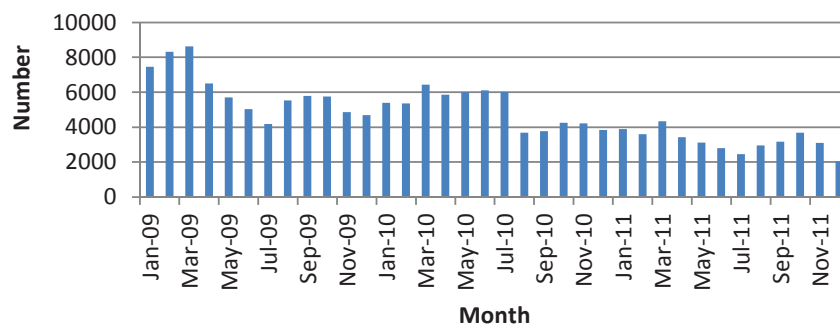

**Figure 25.** Average number of visits to NIOSH Nanotechnology Topic Page.

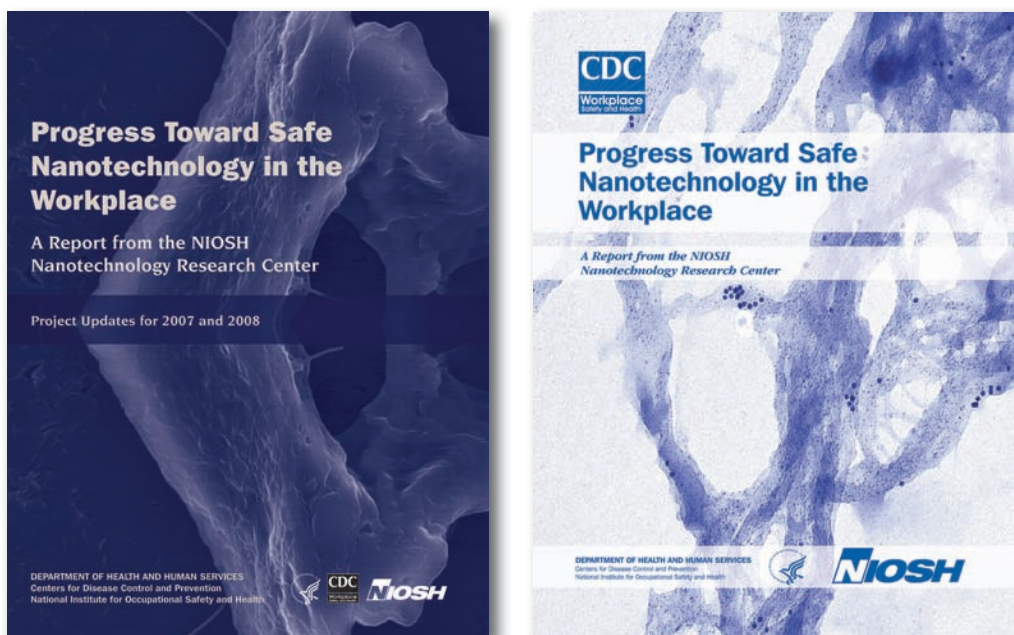

Figure 26. The previously published NTRC Progress Reports.

exposure to CNT causes harmful pulmonary effects (such as acute fibrosis) in mice at relatively low doses. To date, more than 400 articles have been published by the NIOSH nanotechnology program (Appendix A, Figure 27). Publications in the areas of hazard identification and characterization, exposure assessment, risk assessment, and risk management have provided important needed information and a framework for others in addressing potential hazards and risks from engineered nanoparticles.

Because the value of information is determined by those who use it, one measure of the value or outcome of a publication is the number of times it has been cited [Burdorf and Viikara-Juntura 2007; Kostoff et al. 2009]. A diagram of the citation process, with initial citations spawning clusters of secondary citations, is shown in Figure 28.

**As of December 31, 2011, more than 400 NTRC-authored publications pertaining to engineered nanomaterials have been cited over 5,000 times in the peer-reviewed scientific literature. These primary citations have resulted in over 82,000 secondary citations, thus illustrating the impact and reach of NTRC research results in the field of nanotechnology.** As seen in Figure 29, a large number of NTRC-authored journal articles have been much more commonly cited than the average citation value of 5 calculated from 11 journals that NTRC researchers published in. The same holds true even when using a higher value of 20 as an average number of times that publications in biomedical sciences are cited over their lifetime [MacRoberts and MacRoberts 1989]. Citation data were compiled with both Google Scholar and Thomson Reuters Web of Knowledge.



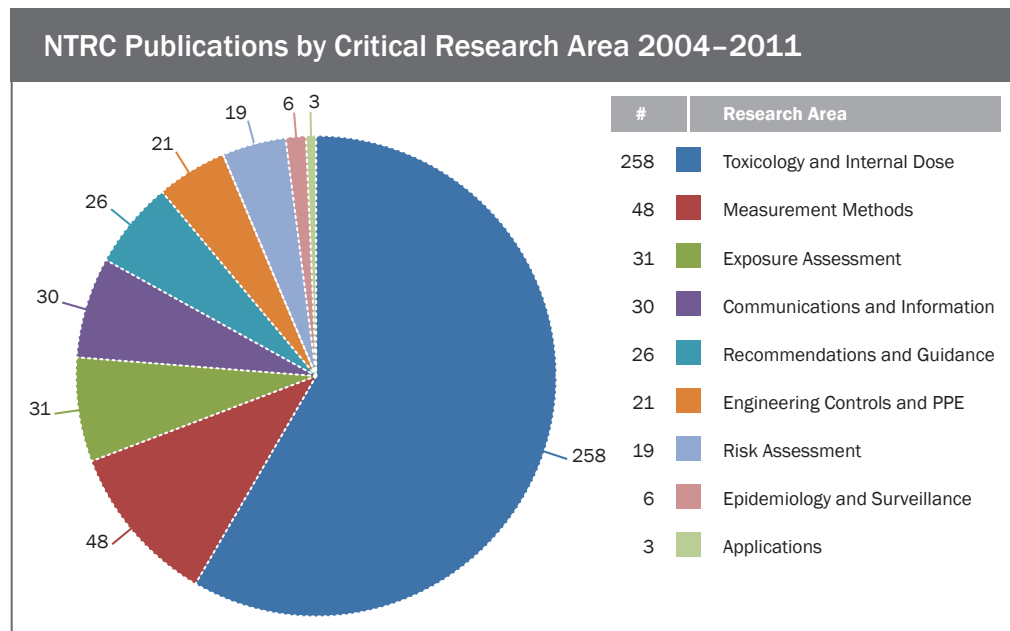

Figure 27. Distribution of journal publications, by critical research area.

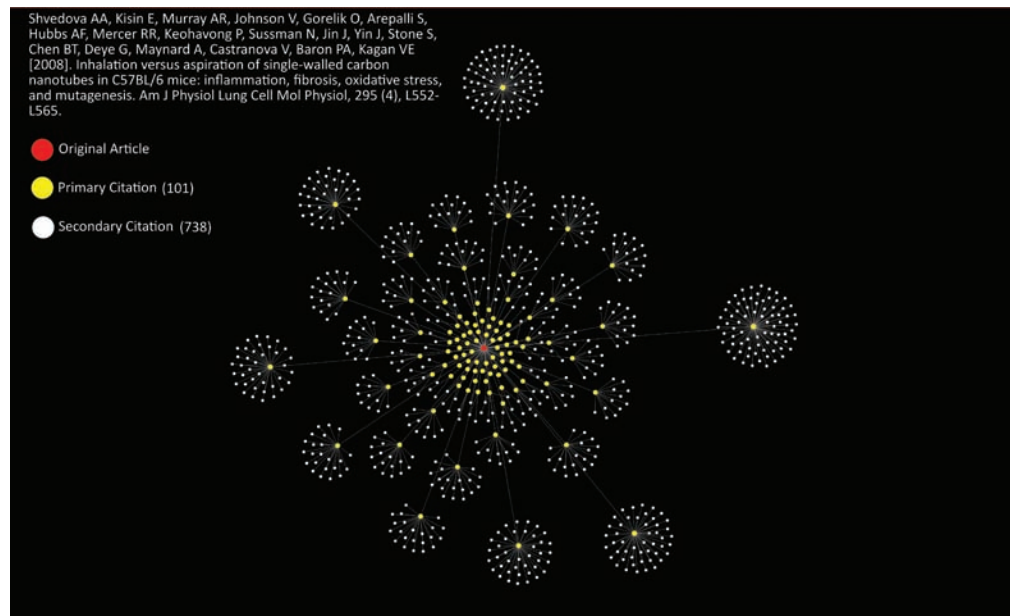
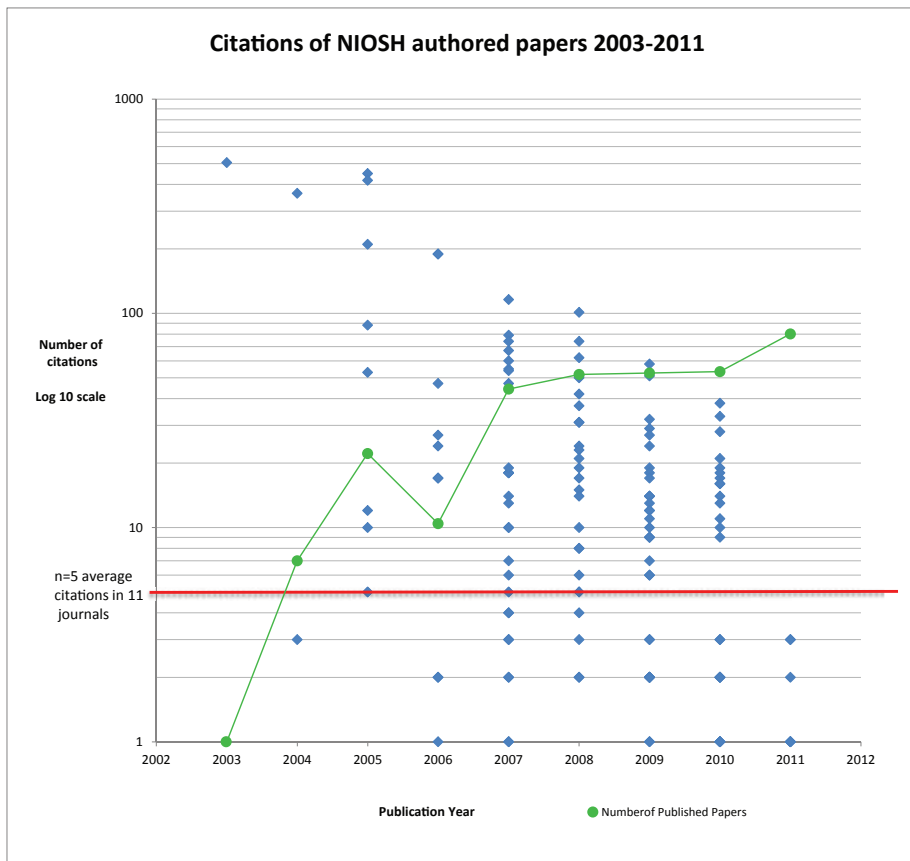

Figure 28. A graphical representation of the Shvedova et al. 2008 paper, *Inhalation Versus Aspiration of Single-Walled Carbon Nanotubes in C57bl/6 Mice: Inflammation, Fibrosis, Oxidative Stress and Mutagenesis*. The scatter plot illustrates the initial publication (red dot) surrounded by the number of times (101) it was directly cited in other papers (primary citations are yellow dots) and then the number of times (738) the primary citation papers were cited by other papers (secondary citations are white dots). This diagram was developed using Cytoscape, an open source platform for complex network analysis and visualization. The paper was one of the first to demonstrate that inhalation of carbon nanotubes would cause pulmonary fibrosis.



**Figure 29.** Citations of NIOSH NTRC-authored publications compared to the average number of citations in 11 biomedical and occupational safety and health journals containing NIOSH publications.\*

\*Scandinavian Journal of Public Health, International Archives of Occupational and Environmental Health, Journal of Toxicology and Environmental Health–Part A–Current Issues, Inhalation Toxicology, Journal of Nanoparticle Research, Journal of Occupational and Environmental Hygiene, Particle and Fibre Toxicology, Annals of Occupational Hygiene, Toxicology Letters, Nature Nanotechnology, and Journal of Aerosol Science.



While citation analysis illustrates the extent to which scientists use and reflect on NTRC research, these citations are influenced by the time since publication. Many of the papers have only been published within the last 2 or 3 years of the time period (2003–2011) and they have not had much opportunity to be cited. The cited half-life (i.e., the number of years going back from the current year) generally is close to 7 years (range, 4.8 to 8.4 years) [Gehanno et al. 2007, Smith 2008]. Consequently, a large number of NIOSH published papers have not been in the literature long enough to reach the average cited half-life, and further citations are anticipated.

### 2.9.2.1 Perspective

To put into perspective the impact of some of the NTRC papers, it is possible to compare the number of times they are cited with other papers that are widely cited. For example, Gehanno et al. [2007] found that among 15,553 articles published in five major occupational medicine journals since 1949, only 85 (0.55%) had been cited more than 100 times. In comparison, the 2003 and 2005 NTRC papers by Shvedova et al. were cited 505 and 449 times, respectively. A review by Kostoff et al. [2009] of the seminal research literature of nanotechnology listed the most highly cited papers going back to 1991. The review focused on physical phenomenon and construct structures rather than on *health-impact-related papers in nanotechnology, but if it had focused on the latter, then the papers by Shvedova et al. [2003 and 2005] would have been the fourth and sixth most cited papers on that seminal list. Clearly, some key NTRC papers identified in this progress report have achieved citation rates comparable to several of the papers that Kostoff et al. assessed as seminal in nanotechnology. Figures 30–37 show the number of citations in eight of the NTRC research areas.*

Six articles published by NTRC researchers from 2008 through 2010 were included in the top-10 most cited articles (as of June 2012), from the *Journal of Occupational and Environmental Hygiene* (JOEH) [<http://www.tandf.co.uk/journals/cited/UOEH.pdf>] (Table 4). This journal has a readership of over 10,000 industrial hygienists and occupational safety and health professionals.

In addition to citations of NIOSH research, NIOSH guidance was also widely cited (Figure 38), as demonstrated by the 80 primary and 661 secondary citations of *Occupational Risk Management of Nanoparticles* [Schulte et al. 2008].

Three articles published by NTRC researchers from 2009 through 2011 were included in the top-5 most cited articles from the *Journal of Toxicology and Environmental Health, Part A* [<http://www.tandfonline.com/toc/uteh20/current#cited>] (Table 5).

In addition, the *Scandinavian Journal of Work, Environment & Health* reported that the 2008 article *Sharpening the Focus on Occupational Safety and Health in Nanotechnology*, by NTRC researchers (Schulte PA, Geraci CL, Zumwalde R, Hoover M, Castranova V, Kuempel E, Murashov V, Vainio H, and Savolainen K; 34:471–478) was one of the top-10 most viewed articles in 2009 [[http://www.sjweh.fi/list\\_top\\_viewed.php?year=2009](http://www.sjweh.fi/list_top_viewed.php?year=2009)]. This journal is distributed to 34 countries on 6 continents and has, according to the journal website, a 5-year impact factor of 3.83.

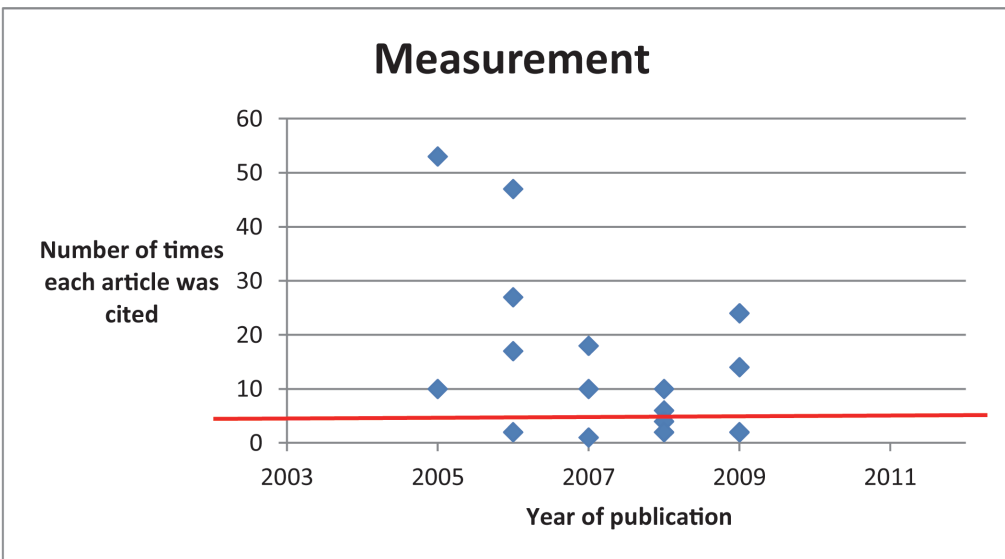
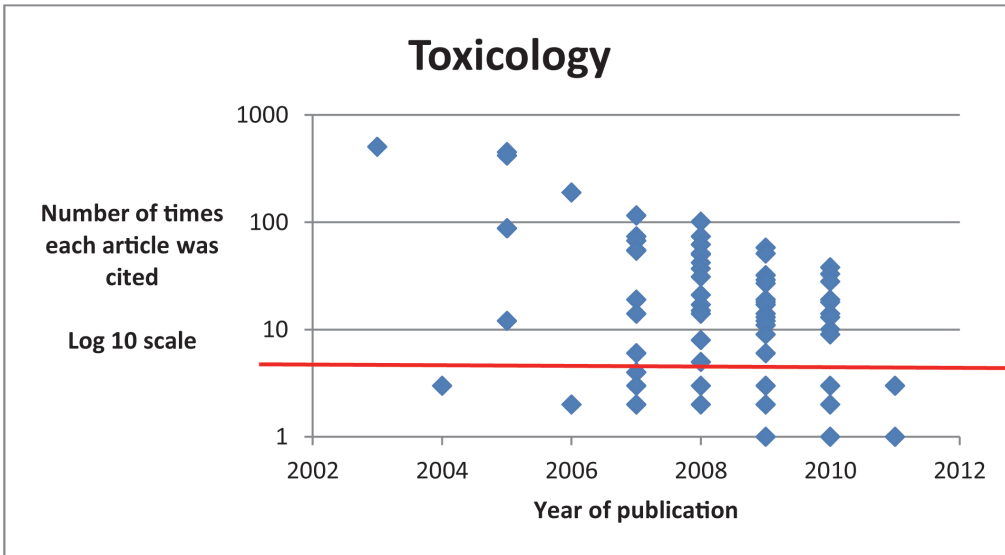

Figures 30–37. Citations by NTRC research area. Recommendations and Guidance and Communications have been combined and there were no publications in the research area of fire and explosion safety. The red line at  $n=5$  is the average number of citations for 11 journals in which the NTRC published.

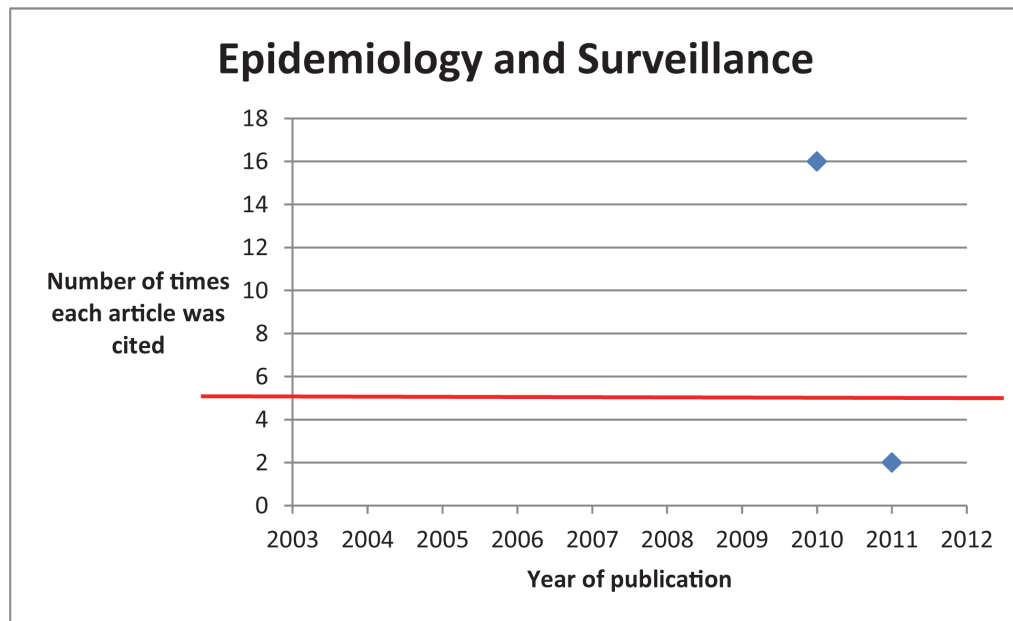
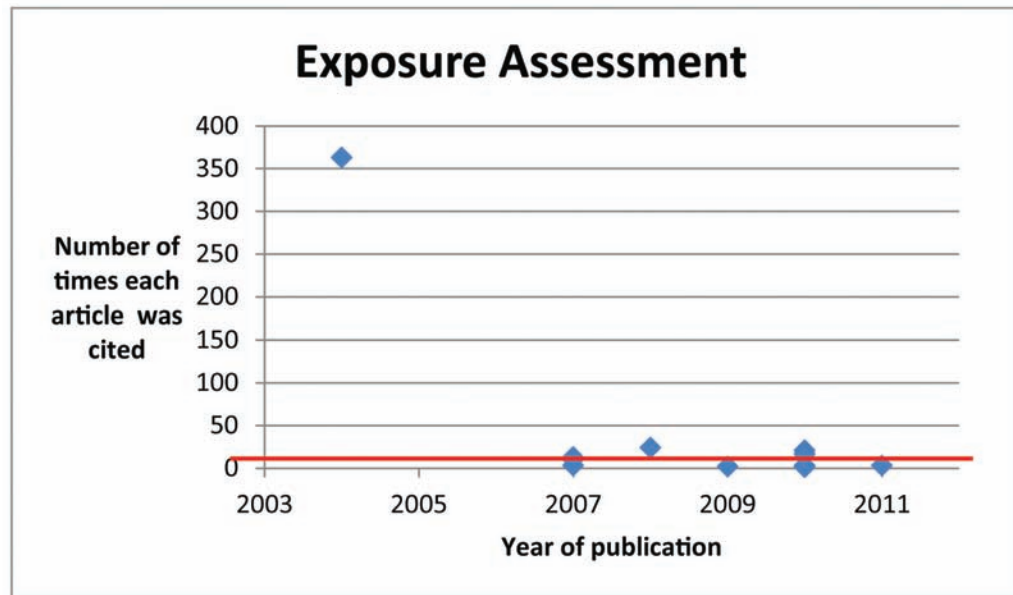

**Figures 30–37 (Continued).** Citations by NTRC research area. Recommendations and Guidance and Communications have been combined and there were no publications in the research area of fire and explosion safety. The red line at  $n=5$  is the average number of citations for 11 journals in which the NTRC published.

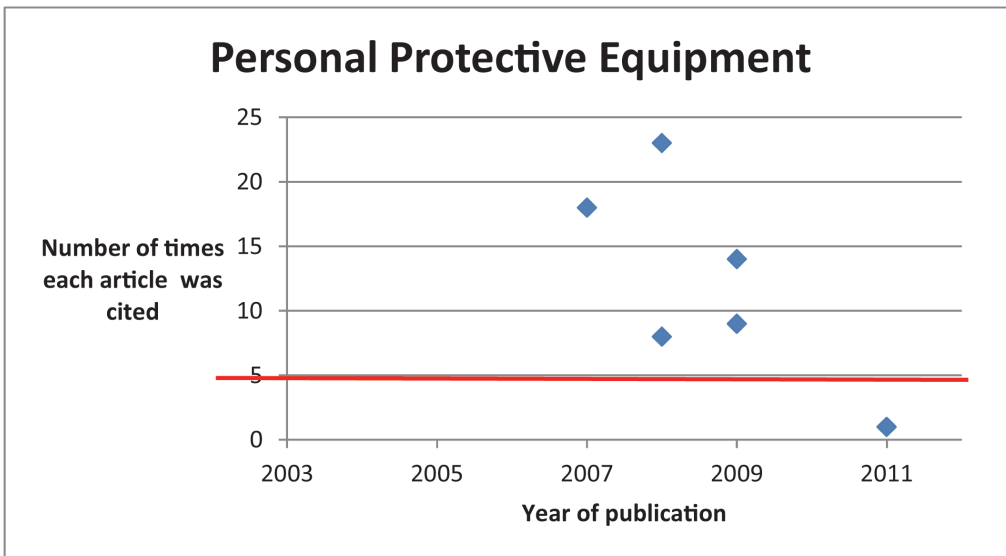
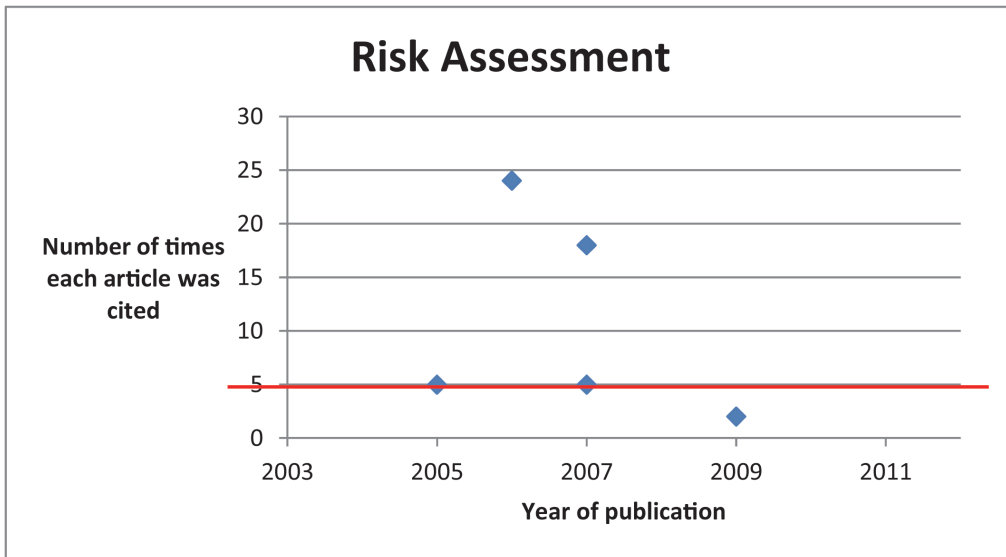

**Figures 30–37 (Continued).** Citations by NTRC research area. Recommendations and Guidance and Communications have been combined and there were no publications in the research area of fire and explosion safety. The red line at  $n=5$  is the average number of citations for 11 journals in which the NTRC published.



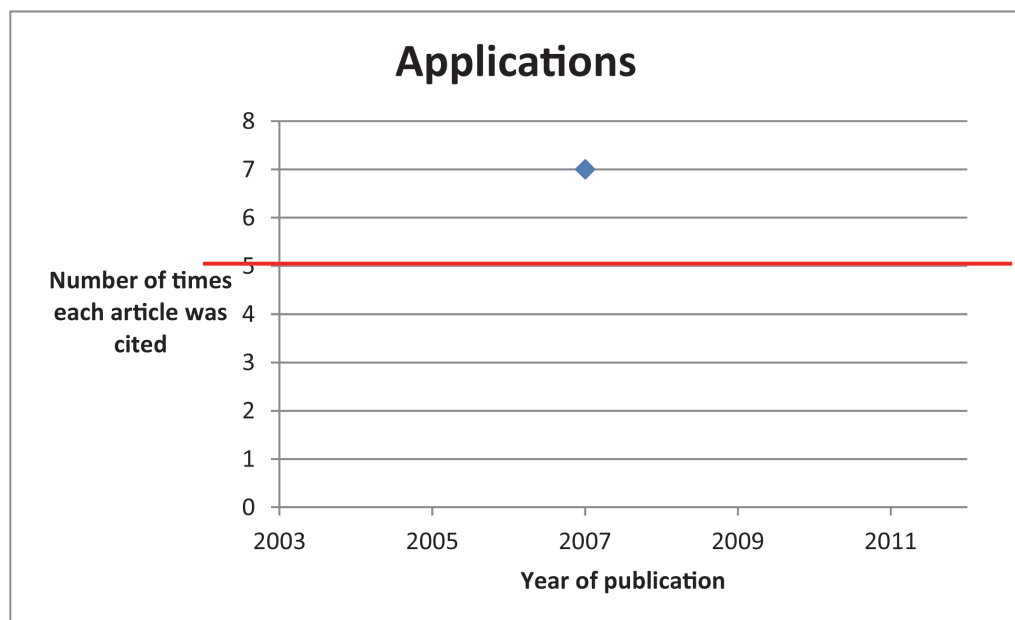
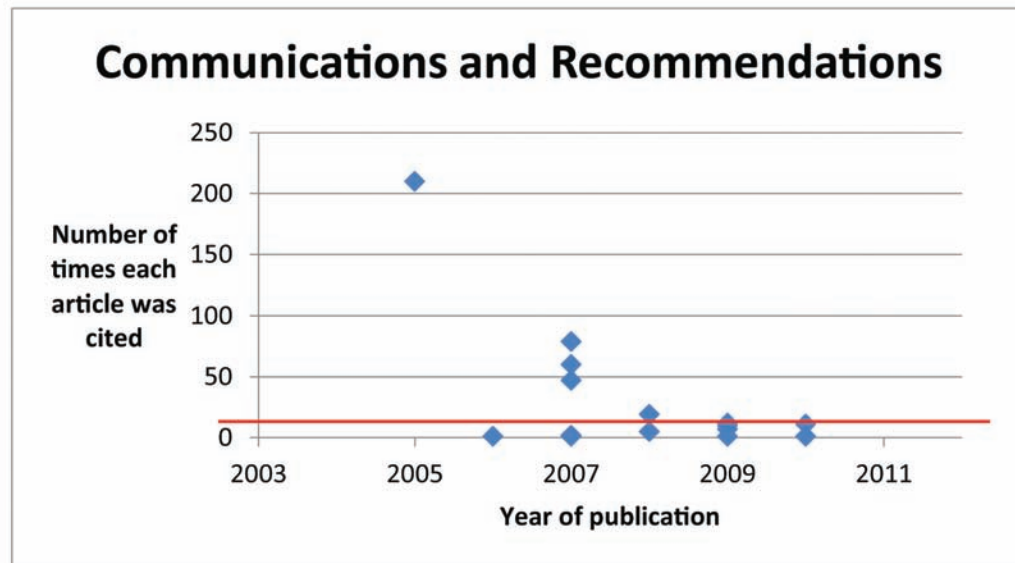

**Figures 30–37 (Continued).** Citations by NTRC research area. Recommendations and Guidance and Communications have been combined and there were no publications in the research area of fire and explosion safety. The red line at  $n=5$  is the average number of citations for 11 journals in which the NTRC published.

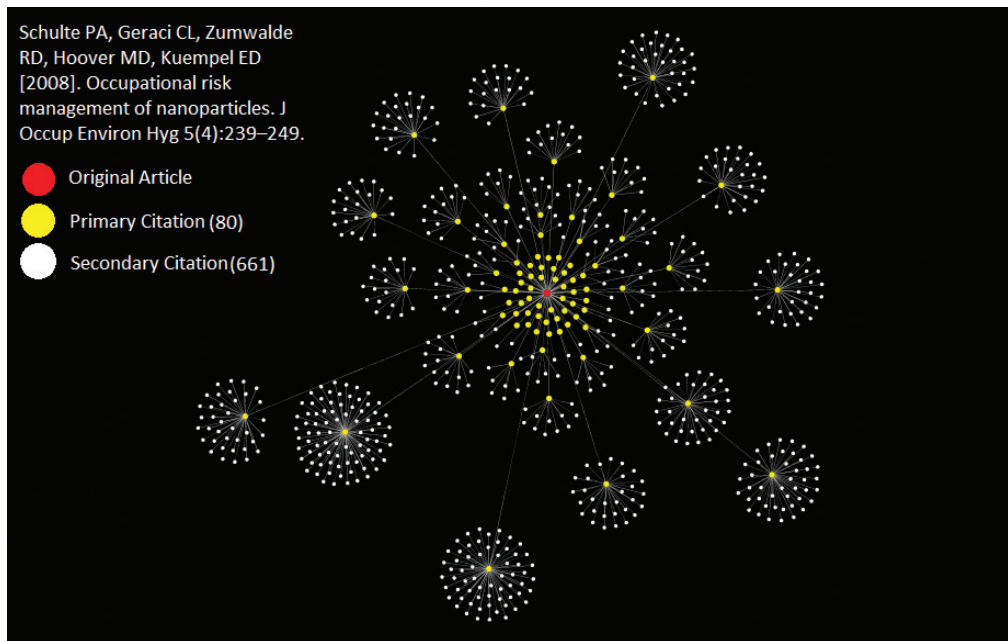

**Figure 38.** A graphical representation of the 80 primary and 661 secondary citations of the 2008 article *Occupational Risk Management of Nanoparticles*.

**Table 4. Six of the top 10 cited JOEH articles for 2008 through 2010 had NIOSH authorship**

Schulte P, Geraci C, Zumwalde R, et al. [2008]. *Occupational Risk Management of Engineered Nanoparticles* (Figure 38), 5(4):239–249.

Methner MM, Old L [2008]. *Effectiveness of Local Exhaust Ventilation (LEV) in Controlling Engineered Nanomaterial Emissions during Reactor Cleanout Operations*, 5(6):D63–D69.

Methner M, Hodson L, Geraci C [2010]. *Nanoparticle Emission Assessment Technique (NEAT) for the Identification and Measurement of Potential Inhalation Exposure to Engineered Nanomaterials—Part A*, 7(3):127–132.

Rengasamy S, King WP, Eimer BC, et al. [2008]. *Filtration Performance of NIOSH-Approved N95 and P100 Filtering Facepiece Respirators against 4 to 30 Nanometer-Size Nanoparticles*, 5(9):556–564.

Methner M, Hodson L, Dames A, et al. [2010]. *Nanoparticle Emission Assessment Technique (NEAT) for the Identification and Measurement of Potential Inhalation Exposure to Engineered Nanomaterials—Part B: Results from 12 Field Studies*, 7(3):163–176.

Heitbrink WA, Evans DE, Ku BK, et al. [2009]. *Relationships Among Particle Number, Surface Area, and Respirable Mass Concentrations in Automotive Engine Manufacturing*, 6(1):19–31.



**Table 5. Three of the top 5 cited articles for Journal of Toxicology and Environmental Health, Part A, 2009 through 2011, had NIOSH authorship**

Wang L, Mercer R, Rojanasakul Y, Qiu A, Lub Y, Scabillonia J, Wuc N, Castranova V [2010]. *Direct Fibrogenic Effects of Dispersed Single-Walled Carbon Nanotubes on Human Lung Fibroblasts*. 73(5-6):410-422.

Rushton EK, Jiang J, Leonard SS, Eberly S, Castranova V, Biswas P, Elder A, Han X, Gelein R, Finkelstein J, Oberdörster G, et al. [2010]. *Concept of Assessing Nanoparticle Hazards Considering Nanoparticle Dosemetric and Chemical/Biological Response Metrics*. 73(5-6):445-461.

Pacurari M, Castranova V, Vallyathan V [2010]. *Single- and Multi-Wall Carbon Nanotubes Versus Asbestos: Are the Carbon Nanotubes a New Health Risk to Humans?* 73(5-6):378-395.

Many of the NTRC journal publications have been nominated for the Alice Hamilton Awards (NIOSH's highest scientific award). A few of the winning publications are listed here.

### 2006 Biological Sciences Category

Shvedova AA, Kisin ER, Mercer R, Murray AR, Johnson VJ, Potapovich AI, Tyurina YY, Gorelik O, Arepalli S, Schwegler-Berry D, Hubbs AF, Antonini J, Evans DE, Ku BK, Ramsey D, Maynard A, Kagan VE, Castranova V, Baron P [2005]. Unusual inflammatory and fibrogenic pulmonary responses to single-walled carbon nanotubes in mice. *Am J Physiol Lung Cell Mol Physiol* 289(5):L698-L708.

### 2009 Biological Sciences Category

Shvedova AA, Kisin E, Murray AR, Johnson VJ, Gorelik O, Arepalli S, Hubbs AF, Mercer RR, Keohavong P, Sussman N, Jin J, Yin J, Stone S, Chen BT, Deye G, Maynard A, Castranova V, Baron PA, Kagan VE [2008]. Inhalation vs. aspiration of single-walled carbon nanotubes in c57bl/6 mice: inflammation, fibrosis, oxidative stress, and mutagenesis. *Am J Physiol Lung Cell Mol Physiol* 295:L552-L565.

### 2010 Biological Sciences Category

Porter DW, Hubbs AF, Mercer RR, Wu N, Wolfarth MG, Sriram K, Leonard S, Battelli L, Schwegler-Berry D, Friend S, Andrew M, Chen BT, Shuji Tsuruoka S, Endo M, Castranova V [2010]. Mouse pulmonary dose- and time course-responses induced by exposure to multi-walled carbon nanotubes. *Toxicology* 269(2-3):136-147.

### 2011 Engineering and Physical Sciences Category

Evans DE, Ku BK, Birch ME, Dunn KH [2010]. Aerosol monitoring during carbon nanofiber production: mobile direct-reading sampling. *Ann Occup Hyg* 54(5):514–531.

### 2011 Bullard Sherwood Award, Research2Practice Knowledge Category

Hodson L, Geraci C, Zumwalde R, Castranova V, Keumpel E, Schulte P, Birch E, Curwin B, Evans D, Gao P, Hoover M, Ku B, Mercer R, Methner M, Murashov V, Pearce T, Rengasamy A, Schubauer-Berigan M, Shaffer R, Shvedova A, Stefaniak A, Trout D, Turkevich L, Williams V, and Fazio G. *Approaches to Safe Nanotechnology: Managing the Health and Safety Concerns Associated with Engineered Nanomaterials*.

### 2.9.3 Collaborations and Partnerships

The fourth goal of the NTRC is to enhance global workplace safety and health through national and international collaborations on nanotechnology research and guidance. NIOSH continues to be an active contributor to the NNI by providing the occupational health and safety expertise in support of the U.S. Government's Strategic Plan for Nanotechnology Health and Safety Research. NIOSH co-chairs the NNI Nanotechnology Environmental and Health Implications (NEHI) Working Group. NTRC researchers made significant contribution to the development of the 2011 NEHI environmental health and safety (EHS) strategy and had primary responsibility for the chapters on human exposure assessment and human health. This EHS research strategy provides guidance to Federal agencies on what research is needed to support the development of risk management policies, regulatory decision-making, product use, research planning, and public outreach. The core research areas in the NNI 2011 EHS Research Strategy are (1) Nanomaterial Measurement Infrastructure, (2) Human Exposure Assessment, (3) Human Health, (4) Environment, (5) Risk Assessment and Risk Management Methods, and (6) Informatics and Modeling.

The NTRC is also conducting several types of research under formal interagency agreements with the National Toxicology Program (NTP), Occupational Safety and Health Administration (OSHA), and Consumer Products Safety Commission (CPSC) and collaborating through a Framework Memorandum with the Department of Defense (DOD). NTRC researchers have informal collaborations with the Environmental Protection Agency (EPA), National Institute of Standards and Technology (NIST), Department of Energy (DOE), and National Aeronautics and Space Administration (NASA). NTRC researchers also 1) serve on the American Society for Testing and Materials (ASTM) standards committees and contribute to ASTM E-56 (Nanotechnology) and 2) chair the ANSI U.S. Technical Advisory Group to ISO Technical Committee 229 Working Group 3 on Nanotechnology Health, Safety, and Environment.

NIOSH has formal partnerships with two research centers under Memoranda of Understanding (MOU). One MOU is with the National Science Foundation (NSF)-funded Center for High-Rate Nanomanufacturing (CHN) at Northeastern University. This MOU provides collaboration with the Nano EHS program at the University of



Massachusetts–Lowell and has provided the opportunity for joint research. A second MOU was developed with the College of Nanoscale Science and Engineering (CNSE), at the State University of New York–Albany. The CNSE partnership provides direct access to the SEMATECH semiconductor industry consortium. Under this partnership NTRC researchers have access to conducting exposure assessments at the CNSE, and NIOSH partnered with CNSE to host a conference in Albany, NY, in summer 2012: Safe Nano Design: Molecule » Manufacturing » Market: Applying Prevention through Design to Nanomaterials [<http://www.cdc.gov/niosh/topics/ptd/nanoworkshop/default.html>]). This first-of-its kind workshop brought together experts in molecular design, toxicology, facility design, exposure assessment, and engineering controls to develop guidance on the application of Prevention through Design principles to nanotechnology.

NIOSH has ongoing collaborations with the International Council on Nanotechnology (ICON) and provides direct support to the GoodNanoGuide at Rice University. NTRC researchers collaborate with the states of California and Massachusetts and have been invited to contribute to several nanobusiness consortia, including the NanoBusiness Commercialization Association, the Nano Panel of the American Chemistry Council, the NanoAlliance of the Society of Chemical Manufacturers and Affiliates, Center of Innovation for Nanobiotechnology (COIN) in North Carolina, and the Consortium for Multifunctional Polymers and Nanodevices (CMPND). NIOSH maintains several private sector partnerships, including close to 40 companies who have sponsored NTRC field research activities. NIOSH maintains working relationships with West Virginia University Nanotechnology Center, West Virginia University Medical School, University of Wisconsin, Madison, University of Iowa, University of Pittsburgh, University of Cincinnati, Birck Center for Nanotechnology at Purdue University, and the University of Dayton Research Institute.

NTRC researchers participate with several health and safety organizations and expert groups, including the American Industrial Hygiene Association (AIHA), American Conference of Governmental Industrial Hygienists (ACGIH), American Society of Safety Engineers (ASSE), Hamner Institutes for Health Sciences, Health Physics Society (HPS), International Safety Equipment Association, International Alliance for Nanotoxicology Harmonization (IAHN), International Life Sciences Institute (ILSI)–based NanoRelease Initiative, Technical Association of the Pulp and Paper Industry's International Nanotechnology Standards Coordination Committee (INSCC), National Safety Council (NSC), and the initiative on Minimum Information Needed for Characterization of Nanomaterials (MINChar).

NTRC researchers participated with experts from 45 other national and international organizations in creating the community-based Nanoinformatics 2020 Roadmap published by the National Nanomanufacturing Network ([www.internano.org/nanoinformatics](http://www.internano.org/nanoinformatics)). Building on experience and input of NTRC researchers, the Roadmap defines nanoinformatics as the science and practice of determining which information is relevant to the nanoscale science and engineering community, and then developing and implementing effective mechanisms for collecting, validating, storing, sharing, analyzing, modeling, and applying that information. The Roadmap provides a framework for the emergence

of nanotechnology in broad sectors of research, development, and commerce, and enables researchers to recognize its potential hazards as well as benefits; evaluate specific applications and exposure situations for nanomaterials; develop controls to prevent or minimize exposure; and confirm the effectiveness of those controls by workplace measurements and epidemiological studies of worker populations. Since its publication in the spring of 2011, the Roadmap has been downloaded more than 1000 times by more than 700 users. The [www.InterNano.org](http://www.InterNano.org) online resource of the National Nanomanufacturing Network provides monthly newsletters and weekly mailers that are distributed to 4,500 subscribers, and it supports the information needs of the nanomanufacturing community by reporting on advances in applications, devices, metrology, and materials that will facilitate the commercial development and marketable application of nanotechnology. Links to NIOSH resources are provided on [InterNano.org](http://InterNano.org).

NTRC researchers have actively shared with health and safety professionals the knowledge and expertise gained from the assessment of exposures in workplaces where various types of engineered nanomaterials are manufactured and used. This sharing of knowledge often includes hands-on training at national, state, and local meetings, workshops, and conferences. The American Industrial Hygiene Association also recorded the training course “Nanoparticles in the Workplace: Assessing and Managing Risks” conducted by NTRC researchers in 2009 and has made the course available on CD-ROM for distance learning. In December 2011, NTRC researchers provided direct assistance to the State of California, Division of Toxic Substances Control, by conducting a day-long training class on nanomaterial exposure assessment techniques. The training class was followed the next day by having the California State staff accompany NTRC researchers on a site visit to a local nano-metal oxide manufacturer to gain hands-on experience for assessing workplace exposures.

On the international level, NIOSH is collaborating with World Health Organization (WHO), United Nations Institute for Training and Research (UNITAR), International Labor Organization (ILO), Organization for Economic Cooperation and Development (OECD), International Organization for Standardization (ISO), International Commission on Occupational Health (ICOH), the NanoImpactNet consortium in the European Union (EU), Japan NIOSH, Safe Work Australia, Institute of Occupational Medicine (IOM), ANSES (Administración Nacional de la Seguridad Social in Argentina), Fundacentro (Brazil), and several European Commission 7th Framework Projects (Figure 39). A member of the NTRC chairs the ICOH Scientific Committee on nanotechnology, and a member of the NTRC chairs the OECD Working Party on Manufactured Nanomaterials steering group (SG) on exposure measurement and exposure mitigation for manufactured nanomaterials (SG8). The OECD publication *Emission Assessment for Identification of Sources and Release of Airborne Manufactured Nanomaterials in the Workplace: Compilation of Existing Guidance* is based on the NIOSH Nanomaterials Emission Assessment Technique described in Appendix A of the NIOSH document *Approaches to Safe Nanotechnology: Managing the Health and Safety Concerns Associated with Engineered Nanomaterials*.

In 2008, NIOSH signed an agreement with ILO to collaborate on several projects specific to nanotechnology, including the development of content for the 5th edition of the ILO Encyclopedia.





**Figure 39.** NIOSH global collaborations.

NIOSH leads the development of a nanotechnology topic page for the World Health Organization ([http://www.who.int/occupational\\_health/topics/nanotechnologies/en/](http://www.who.int/occupational_health/topics/nanotechnologies/en/)). Most recently NIOSH also expanded its leadership in developing global nanotechnology workplace guidance documents for WHO and the Inter-organizational Program for Sound Management of Chemicals.

NTRC researchers are coordinating efforts with the Netherlands Organization for Applied Scientific Research (TNO), Partnership for European Research in Occupational Safety and Health (PEROSH), and NanoImpactNet to develop a global exposure registry database. They are also leading the development of a health surveillance project incorporating exposure registries in the International Occupational Hygiene Association (IOHA).

NIOSH, through its collaborations with ISO, OECD, and WHO, fosters the translation of NIOSH nanotechnology guidance documents into other languages. For example, China Occupational Safety and Health Association is translating *Approaches to Safe Nanotechnology* into Mandarin. NTRC researchers worked with the Italian National Institute for Occupational Safety and Prevention to translate and publish the NIOSH nanotechnology brochure into Italian.

### Highlights of NIOSH Collaboration Activities and Outcomes

NIOSH led the development of *WHO Guidelines on Protecting Workers from Potential Risks of Manufactured Nanomaterials* ([http://www.who.int/occupational\\_health/topics/nanotechnologies/en/](http://www.who.int/occupational_health/topics/nanotechnologies/en/)).

NIOSH's international partnership with the Organisation for Economic Co-operation and Development (OECD) to examine potential occupational health and safety risks from nanoparticles is reflected in the OECD *Report of the Workshop on Risk Assessment of Manufactured Nanomaterials in a Regulatory Context*. NIOSH representatives participated in the workshop and contributed to the report. The workshop provided input for an SG6 document on issues relating to risk assessment methods for engineered nanoparticles. For more information, see [http://www.oecd.org/LongAbstract/0,3425,en\\_2649\\_37015404\\_45020877\\_1\\_1\\_1\\_1,00.html](http://www.oecd.org/LongAbstract/0,3425,en_2649_37015404_45020877_1_1_1_1,00.html).

NIOSH research provided the Consumer Product Safety Commission (CPSC) with valuable information on the nature of a TiO<sub>2</sub> product (aerosol characterization); the potential for consumer exposure (simulated use); and the health hazard potential (animal toxicology testing of the product). This work provided CPSC with important data needed to conduct a consumer-based risk assessment on a spray aerosol product containing nanoparticles and support the development of a policy on this class of products. CPSC is extending its collaboration with NIOSH to include the testing of nano-silver-containing products.

NIOSH is recognized as one of the leading agency participants in the U.S. National Nanotechnology Initiative (NNI) because of its expertise in nanotechnology and development of guidance on the safe handling of engineered nanomaterials.

## 2.10 Applications

NTRC researchers have developed nano-enabled sensors used as end-of-life service indicators for respiratory protection devices. The first application integrated them into air-purifying respirator (APR) and powered air-purifying respirator (PAPR) cartridges for evaluation. Research findings are now being used to update NIOSH PAPR respirator standards related to the useful service life of air-purifying cartridges.

NTRC researchers collaborated in the development of new nanomaterials for chemical sensing. This research resulted in a patent assigned to the Regent of the University of California: Sailor, Ruminski, King, and Snyder, "Optical fiber-mounted porous photonic crystals and sensors," U.S. Patent #7,889,954, issued Feb. 15, 2011. Improved sensitivity and specificity in chemical sensing will have beneficial applications in monitoring exposures to toxic materials in the workplace and will have broad utility in emergency response.

## 2.11 Summary of NIOSH NTRC Progress Through 2011

Nanotechnology, a rapidly emerging application of multiple technologies to materials at the nanoscale, has been identified as an important U.S. commercial enterprise that



**Figure 40.** Nanomaterial worker safety and health: critical for responsible development of the technology and societal benefit

has global scientific and economic benefits. Workers are the first people in society exposed to a new technology and the resulting new or transformed materials. Concerns about nanomaterial worker health and safety must be addressed to ensure the responsible development and associated economic growth. This responsible development is built on addressing worker safety and health (Figure 40).

The emerging nanomaterial manufacturing community has repeatedly stated that it cannot operate effectively in an environment of uncertainty created by a lack of authoritative recommendations from government agencies (Lekus et al. 2006; U.S. Department of Commerce 2007). The availability of recommendations has been identified as necessary for the implementation of effective risk management programs. NIOSH is meeting this mandate by conducting research and disseminating information on preventive and precautionary practices that protect the workforce and promote the responsible development of nanotechnology in the U.S. and globally.

NIOSH was *one of the earliest occupational safety and health agencies globally* to develop guidance on the identification, measurement, and control of occupational exposures to engineered nanoparticles, in the 2005 report *Approaches to Safe Nanotechnology: An Information Exchange with NIOSH*. Researchers with the NIOSH NTRC were also the first to conduct the scientific research and comprehensive scientific data assessment necessary to develop recommended exposure limits (RELs) for TiO<sub>2</sub> and CNTs/CNFs. CIB 63: *Occupational Exposure to Titanium Dioxide*, was published in May 2011, and the

CIB *Occupational Exposure to Carbon Nanotubes and Carbon Nanofibers* was released for public review in November 2010; both documents provide risk management recommendations based on results from NTRC research and from the partnerships with the private sector.

Nanotoxicologic research conducted by the NTRC is considered instrumental in the initial determination in laboratory animal studies that exposure to certain types of engineered nanoparticles have the potential to result in serious health effects involving pulmonary, cardiovascular, and possibly other organ systems. NTRC researchers have identified a broad range of potential health effects and nanoparticle physical and chemical parameters of importance in toxicity.

NIOSH helped to establish the U.S. and international position that a precautionary approach to controlling exposures to engineered nanoparticles is warranted [Schulte and Salamanca-Buentello 2007; Schulte et al. 2008; Murashov and Howard 2008; Howard and Murshov 2009]. Workplace exposure characterization and engineering control evaluation studies have also shown that a range of *NIOSH-recommended control strategies* are being used. In addition, recommendations from these reports have resulted in companies' adopting process changes and implementation of improved engineering controls [Dahm et al. 2011; Methner 2010; Methner 2011; Lo 2011; Evans et al. 2010].

When NIOSH published its first progress report in 2007, NTRC researchers had already published more than 70 articles in the peer-reviewed scientific literature. The number of publications increased to over 170 in the 2009 Progress report, and as of the end of 2011 more than 400 articles had been published in support of the NIOSH NTRC nanotechnology program since its inception. Some of the highlights of the NIOSH NTRC program and publications are listed in Table 6.

The NTRC will continue to evaluate its research progress in nanotechnology through a series of internal and external reviews. For example, past evaluations have included external peer review by the National Academies, as well as a peer review of the NTRC strategic plan by the NIOSH Board of Scientific Counselors with input from a work group of subject matter experts. The review of the last NTRC strategic plan led the NIOSH NTRC to coalesce its priorities to complete the CIBs for TiO<sub>2</sub> and CNTs/CNFs. The NTRC will continue to conduct annual program reviews and regular project reviews and to publish progress reports.

Progress toward meeting the NIOSH NTRC strategic goals is described in Appendices A, B, and C, which contain project summaries, a list of NTRC projects by critical area, and a report of funded extramural activities. Appendix D describes the NIOSH logic and operational models that govern all NIOSH research. Appendix E summarizes how the performance measures of the NTRC Strategic Plan have been met. Appendix F contains the list of citation numbers.

## 2.12 Summary of the Impact of NIOSH Investment in Nanotechnology

Achieving responsible development of nanotechnology requires that the critical elements of worker safety and health be addressed early in the life cycle of

**Table 6. Highlights of the NTRC program and publication activities for 2003–2011**

Year	Highlights
2003	Toxicologic studies on CNT begun
2004	NTRC established
2004	Co-sponsored the First Symposium on Occupational Health Implications of Nanomaterials
2005	First Health Hazard Evaluation at a facility handling carbon nanofibers
2005	Nanotechnology Topic Web Page created
2005	<i>Approaches to Safe Nanotechnology: An Information Exchange</i> posted on the Web
2006	NTRC Field team established
2006	Co-sponsored the NanOEHS conference in Cincinnati, OH
2006	First Progress Report published
2007	70+ NTRC Publications
2008	<i>Safe Nanotechnology in the Workplace an Introduction for Employers, Managers and Safety and Health Professionals</i> published
2009	170+ NTRC Publications
2009	<i>CIB 60: Interim Guidelines for Medical Screening and Hazard Surveillance for Workers Potentially Exposed to Engineered Nanomaterials</i> published
2009	<i>Approaches to Safe Nanotechnology, Managing the Health and Safety Concerns Associated with Engineered Nanomaterials</i> published
2009	<i>Strategic Plan for NTRC 2009–2012</i> published
2010	<i>Draft CIB, Occupational Exposure to Carbon Nanotubes and Carbon Nanofibers</i> published on Web
2011	<i>CIB 63: Occupational Exposure to Titanium Dioxide</i> published
2011	40+ Field Assessments completed
2011	400+ NTRC Publications
2011	Co-sponsor of the Fifth International Conference on Nanotechnology–Occupational and Environmental Health

any application. NIOSH has been a leader in identifying hazards of nanomaterials, evaluating exposures, and characterizing risks to workers, and has provided extensive guidance to protect workers in the face of broad uncertainties in these areas (Table 7). NIOSH toxicology-based hazard identification has vastly increased scientific knowledge about potential hazards of nanomaterials. This increase in scientific knowledge has moved scientists to develop further research and more effectively address knowledge gaps. NIOSH efforts laid the groundwork for developing reliable procedures for generating nanomaterial aerosols so that realistic animal studies could be conducted. The investment of \$42.6 million over seven years has served to drive scientific research, as illustrated by the large number of citations of NIOSH publications. Moreover, the pioneering toxicological work served to focus exposure assessment efforts on high priority materials so that the actual exposure of workers could be characterized. Building on the hazard and exposure information, NIOSH developed a broad range of risk management guidance that became a cornerstone in the national and global response to nanotechnology. NIOSH has helped define the world's precautionary approach to nanotechnology and provided the technical, scientific, and health information to protect workers and develop the technology responsibly.





**Table 7. Impact of NIOSH investment in nanotechnology**

Gaps in the protection of workers and critical research area	Approximate investment 2004–2011	Outputs	Outcomes
<p><b>Hazard Identification</b></p> <p>Is there reason to believe this material could be harmful?</p> <ul style="list-style-type: none"> <li>• Toxicology</li> <li>• Fire and explosibility</li> <li>• Metrology</li> </ul>	<p>\$12.3 million</p>	<p>258 nanotoxicology journal publications that included findings of genotoxicity, cytotoxicity, neurotoxicity, and cardiovascular and respiratory disease in association with various types of nanoparticles (e.g., CNT).</p> <p>Completed 30 nanotoxicology research projects.</p> <p>Over 200 presentations at national and international meetings and conferences pertinent to the toxicity of engineered nanoparticles.</p> <p>9 presentations pertinent to dustiness and flammability of engineered nanoparticles.</p>	<p>Over 5,000 primary and 83,000 secondary citations of NIOSH research papers.</p> <p>Toxicity studies with CNT helped to establish an understanding of possible mechanisms for causing adverse health effects, which may be useful for estimating the potential toxicity of other nanoparticles of similar physical/chemical characteristics. Hazard findings of CNT and CNF toxicity have resulted in the adoption of workplace risk management practices to prevent worker exposure.</p> <p>Awareness was raised of possible flammability of carbonaceous nanomaterials.</p> <p>Most toxicological research drove the assessment of exposure and the development of guidance to protect workers and develop the technology responsibly.</p>
<p><b>Hazard Characterization</b></p> <p>How and under what conditions could it be harmful?</p> <ul style="list-style-type: none"> <li>• Toxicology</li> <li>• Metrology</li> <li>• Field exposure assessments</li> <li>• Epidemiologic and hazard surveillance</li> </ul>	<p>\$13.7 million</p>	<p>258 nanotoxicology journal publications that included findings of genotoxicity, cytotoxicity, neurotoxicity, and cardiovascular and respiratory disease in association with various types of nanoparticles (e.g., CNT).</p> <p>40+ field team assessments and reports, 31 nanomaterial exposure assessment journal articles, and 48 nanomaterial measurement journal articles that</p> <p>1) described techniques and exposure assessment strategies used for characterizing workplace exposures and 2) exposure measurement data.</p> <p>Completed feasibility study and published results on epidemiology study of workers exposed to carbonaceous nanomaterials.</p>	<p>Data used to complete risk assessments of TiO<sub>2</sub>, CNT, and CNF.</p> <p>Raised awareness among nanomaterial producers on the potential hazards of engineered nanomaterials and steps that can be taken to minimize workplace exposures.</p> <p>Engaged the occupational health community in medical surveillance, exposure registries, and epidemiologic studies through presentations and workshops.</p> <p>Partnerships with the private sector accelerated the dissemination and adoption of NIOSH recommendations.</p>

(continued)

**Table 7 (Continued). Impact of NIOSH investment in nanotechnology**

Gaps in the protection of workers and critical research area	Approximate investment 2004–2011	Outputs	Outcomes
<p><b>Exposure Assessment</b></p> <p>Will there be exposures in real-world conditions?</p> <ul style="list-style-type: none"> <li>• Field exposure assessments</li> <li>• Metrology</li> <li>• Engineering controls and PPE</li> </ul>	\$1.1.8 million	<p>40+ field team assessments and reports, 31 nanomaterial exposure assessment journal articles, and 48 nanomaterial measurement journal articles that 1) described techniques and exposure assessment strategies used for characterizing workplace exposures, and 2) exposure measurement data.</p> <p>Developed innovative applications of measurement strategies, including methods for sampling different types of engineering nanoparticles.</p> <p>Collaborated with the National Institute of Standards and Technology (NIST) and National Research Council (NRC) Canada to identify and develop nanoscale reference materials (RMs) for use in calibrating and evaluating measurement instruments and for toxicology studies. A titanium dioxide nanopowder was qualified as a RM, and current efforts focus on qualifying nanocrystalline cellulose (powder and suspension) and SWCNTs as RMs.</p>	<p>Research institutions and companies manufacturing or using engineered nanoparticles adopted many of the techniques recommended by NIOSH scientists on the collection and analysis of engineered nanoparticles.</p> <p>Exposure assessment studies conducted by NIOSH scientists resulted in recommendations for controlling exposure, which were frequently adopted by health and safety professionals.</p> <p>NIST and NRC will be providing nanoscale reference materials.</p>
<p><b>Risk Characterization</b></p> <p>Is substance hazardous and will there be exposure?</p> <ul style="list-style-type: none"> <li>• Risk assessment</li> <li>• Epidemiologic research</li> <li>• Medical surveillance</li> </ul>	\$1.4 million	<p>NIOSH scientists conducted novel risk assessments on TiO<sub>2</sub> and carbon nanotubes (CNT) that were published in the documents:</p> <ol style="list-style-type: none"> <li>1. CIB 63: Occupational Exposure to TiO<sub>2</sub> (NIOSH Pub No. 2011–160).</li> <li>2. CIB, Occupational Exposure to Carbon Nanotubes and Nanofibers (draft Dec 2010).</li> </ol> <p>NIOSH sponsored a workshop on issues related to epidemiology studies, medical surveillance, and worker exposure registries; the findings of that workshop were published in the <i>Journal of Occupational and Environmental Medicine</i>, “Nanomaterials and Worker Health” 2011:53 (6S).</p>	<p>NIOSH published recommended exposure limits for TiO<sub>2</sub> and CNT and CNF based on risk assessments conducted by NIOSH scientists.</p> <p>Engaged the occupational health community in medical surveillance, exposure registries, and epidemiologic studies by presentations, conferences, and workshops.</p> <p>Foundation for hazard banding shared among global partners as a means for identifying workplace exposures to engineered nanomaterials when information on the potential toxicity is limited.</p>

(continued)



**Table 7 (Continued). Impact of NIOSH investment in nanotechnology**

Gaps in the protection of workers and critical research area	Approximate investment 2004–2011	Outputs	Outcomes
<p><b>Risk Management</b></p> <p>Develop procedures to minimize exposures</p> <ul style="list-style-type: none"> <li>• Risk communication</li> <li>• Guidance development</li> </ul>	\$3.4 million	<p>Co-sponsored 16 conferences on issues pertinent to the potential health risks of engineering nanomaterials and the implementation of appropriate risk management practices.</p> <p>NIOSH developed guidance documents:</p> <ol style="list-style-type: none"> <li>1. Approaches to Safe Nanotechnology (NIOSH Pub No. 2009–125).</li> <li>2. CIB: Occupational Exposure to Carbon Nanotubes and Nanofibers (draft published 2010).</li> <li>3. CIB 63: Occupational Exposure to Titanium Dioxide (NIOSH Pub No. 2011–160).</li> <li>4. General Safe Practices for Working with Engineered Nanomaterials in Research Laboratories (NIOSH Pub No. 2012–147).</li> </ol> <p>Created NIOSH Topic Page</p> <p>Provided over 220 presentations at local, national, and international venues pertinent to health and safety information and recommendations.</p> <p>Contributed to international collaborations on the development of risk management practices.</p>	<p>Raised awareness among nanomaterial producers and users on the potential hazards of engineered nanomaterials and steps that can be taken to minimize workplace exposures.</p> <p>Approaches to Safe Nanotechnology downloaded over 11,000 times from the NIOSH web site.</p> <p>Approaches to Safe Nanotechnology translated into Mandarin, Japanese, and Spanish. Approaches to Safe Nanotechnology brochure translated into Japanese, Italian, Spanish, and Portuguese.</p> <p>GoodNanoGuide co-sponsored by NIOSH</p> <p>Recommendations by NIOSH were used in the development of:</p> <ol style="list-style-type: none"> <li>1. ISO Standard published, ISO/TR 12885:2008 Health and Safety Practices in Occupational Settings Relevant to Nanotechnologies</li> <li>2. Development of WHO’s nanotechnology topic page</li> <li>3. OECD sponsored workshops on nanomaterial exposure measurement and exposure mitigation.</li> </ol> <p>Preliminary indication of the wide use of risk management strategies.</p>

### 3 Alignment with the NNI EHS Strategy

NIOSH uses the National Nanotechnology Initiative (NNI) Environmental, Health and Safety (EHS) Research Strategy to help establish and align the objectives of the NTRC program and to identify research projects that provide direct support to specific EHS research needs. The 2008 NNI strategy confirmed that the research priorities and goals established by the NTRC were aligned with the broader EHS issues identified by the NNI (Table 8).

NIOSH continues to be an active participant and contributor to the NNI by providing the occupational health and safety expertise in support of the U.S. Government's Strategic Plan for Nanotechnology Health and Safety Research. NIOSH co-chairs the NNI Nanotechnology Environmental and Health Implications (NEHI) Working Group (Section 2.9.3). NTRC researchers contributed significantly to the development of the 2011 NEHI EHS research strategy, and had primary responsibility for the chapters on human exposure assessment and human health.

The NNI EHS research strategy focuses on the use of science-based risk analysis and risk management to protect the public health and the environment while fostering the technological advancements that benefit society. This strategy is consistent with the NTRC nanotechnology strategic plan, which includes research activities in nanomaterial measurement; human exposure; human health; risk assessment and risk management; and informatics and modeling.

In addition to the NEHI Working Group, NIOSH also has agency level representation on the Nanoscale Science, Engineering and Technology (NSET) Sub-Committee. NSET coordinates the overall U.S. government effort in nanotechnology. Meeting key challenges of health and safety is recognized by NSET as a critical element in promoting the technology. NIOSH provides expert technical support to NSET to meet that challenge.

NTRC research objectives will continue to align with the 2011 NNI EHS research strategy in the development of the FY2013–FY2016 NTRC Strategic Plan (Section 5).



**Table 8. Alignment of critical research areas with the four strategic goals of the NIOSH NTRC (2009–2012) and the 2008 NNI EHS priority environmental health and safety areas**

NIOSH NTRC strategic goals	Toxicity and internal dose	Measurement methods	Exposure assessment <sup>2</sup>	Epidemiology and surveillance	Risk assessment	Engineering controls and PPE	Fire and explosion safety	Recommendations and guidance	Communication and information	Applications
1. Determine if nanoparticles and nanomaterials pose risks for work-related injuries and illnesses	✓ <sup>3</sup> A2 <sup>4</sup> B1 B2 B3 B4 B5	✓ A1 A2 A3 A4 A5 B2	✓ A1 A2 D1 D4 D5 E1 E2	✓ D1 D2 D3 D4 E4	✓ A2 B1 B2 D4 E3	✓ D5	✓ A2			
2. Research application of nanotechnology to prevent work-related injuries and illnesses <sup>1</sup>	✓					✓				✓
3. Promote healthy workplaces through interventions, recommendations, and capacity building		✓ E1	✓ E2	✓ E4	✓ E3 E5	✓ E1		✓ E1 E5	✓ E1 E5	
4. Enhance global workplace safety and health <sup>1</sup>	✓	✓	✓	✓	✓	✓	✓	✓	✓	✓

1. The NNI EHS plan does not address applications or global activities pertaining to environmental health and safety of nanomaterials. However, the NIOSH efforts described herein are consistent with the overall NNI strategy, which identifies international opportunities for collaboration.  
 2. NIOSH is the lead agency for the NNI EHS Strategic Area on human and environmental exposure assessment.  
 3. A ✓ indicates that a goal is addressed by projects within the NIOSH critical research area.  
 4. Alpha-numeric identifications indicate alignment of the NIOSH critical research area with the 2008 NNI priority research needs.

## 4 NIOSH Extramural Nanotechnology Research Activities

The NIOSH Office of Extramural Programs (OEP) manages the competitive process for awarding occupational safety and health grants and cooperative agreements to the research community outside the Institute. This process includes peer review, program relevance, and priorities from the National Occupational Research Agenda (NORA), the NIOSH r2p initiative, congressional mandates, and sector, cross-sector, or coordinated emphasis areas of the NIOSH Program Portfolio (<http://www.cdc.gov/niosh/programs>). From FY-01 to FY-04, OEP funded three R43/44 projects.

In FY-05, NIOSH funded two nanotechnology research grants through the R01 Program Announcement. OEP also began participating in requests for applications (RFAs) for Nanotechnology Research Grants Investigating Environmental and Human Health Issues. For the first RFA, 83 applications were received and 19 were recommended for funding. Fourteen of these met NIOSH criteria for relevance to occupational safety and health. Five of these were in the competitive range for funding consideration and one was funded by NIOSH. EPA funded 14 projects and NSF funded two projects under this RFA.

In FY-06, 81 applications were received in response to the joint RFA on environmental and human health issues. Six of these met NIOSH criteria for relevance, and three of these were in the competitive range for funding consideration. NIOSH was able to fund one application. EPA funded 21 projects, NSF funded 4, and NIEHS funded 3 under this RFA. NIOSH also funded two SBIR grants on nanotechnology in FY-06.

In FY-07, NIOSH funded a three-year career development (mentored scientist) grant involving research at the University of Iowa on personal exposure to nanoparticles. In addition, a two-year exploratory/developmental research project was funded at Colorado State University. NIOSH also participated in RFA-ES-06-008 Manufactured Nanomaterials: Physico-chemical Principles of Biocompatibility and Toxicity, which was jointly sponsored by NIEHS, EPA, and NIOSH.

In FY-08, NIOSH funded a major research grant (R01) from the joint RFA on Manufactured Nanomaterials (Physico-chemical Principles of Biocompatibility and Toxicity). This project was conducted at the University of Iowa. NIOSH also funded a small research grant (R03) at Colorado State University and an SBIR grant at Nanoscale Materials, Inc., in Kansas.

In FY-09 and FY-10, nanotechnology-related research proposals submitted to standing program announcements were considered for funding. NIOSH plans to continue collaborative efforts with EPA/NCER, NSF, NIH/NIEHS, and other international agencies to support nanotechnology research with occupational safety and health implications. OEP will continue to consult with the NTRC regarding needs and future directions for nanotechnology research.

Summaries of the extramural projects funded by NIOSH/OEP are included in Appendix C as part of this portfolio project summary update. Contact information for the principal investigators of the projects is provided in Table C-2.





## 5 The Next Steps

The NTRC will follow the successes established in its first seven years by continuing to work concurrently in all of the major areas of research needed to close knowledge gaps in the the safety and health implications of engineered nanomaterials. Specifically, the NTRC will continue to generate toxicologic data for hazard identification; conduct dose/response risk assessments; evaluate worker exposures and characterize risk; develop, disseminate and assist employers in implementing risk management practices; and continue to develop and disseminate effective communication products and authoritative recommendations. Figure 3 (*Gaps that need to be filled to protect nanomaterial workers*) provides a visual representation of the critical areas of research. For the period 2013–2016, NIOSH will continue to fill information and knowledge gaps by focusing on priority research areas to protect the nanotechnology workforce as shown in Figure 41.

In meeting the NIOSH NTRC Strategic Goals for FY2013– FY2016, the NTRC will accomplish the following:

1. Increase understanding of potential hazards and related health risks to nanomaterial workers
2. Expand understanding of the initial hazard findings of engineered nanomaterials
3. Support the creation of guidance materials to inform nanomaterial workers, employers, health professionals, regulatory agencies and decision makers about hazards, risks, and risk management approaches
4. Support epidemiologic studies for nanomaterial workers, including medical and exposure studies
5. Assess and promote national adherence with risk management guidance, particularly on exposure assessment, control technology, PPE, and occupational exposure limits.

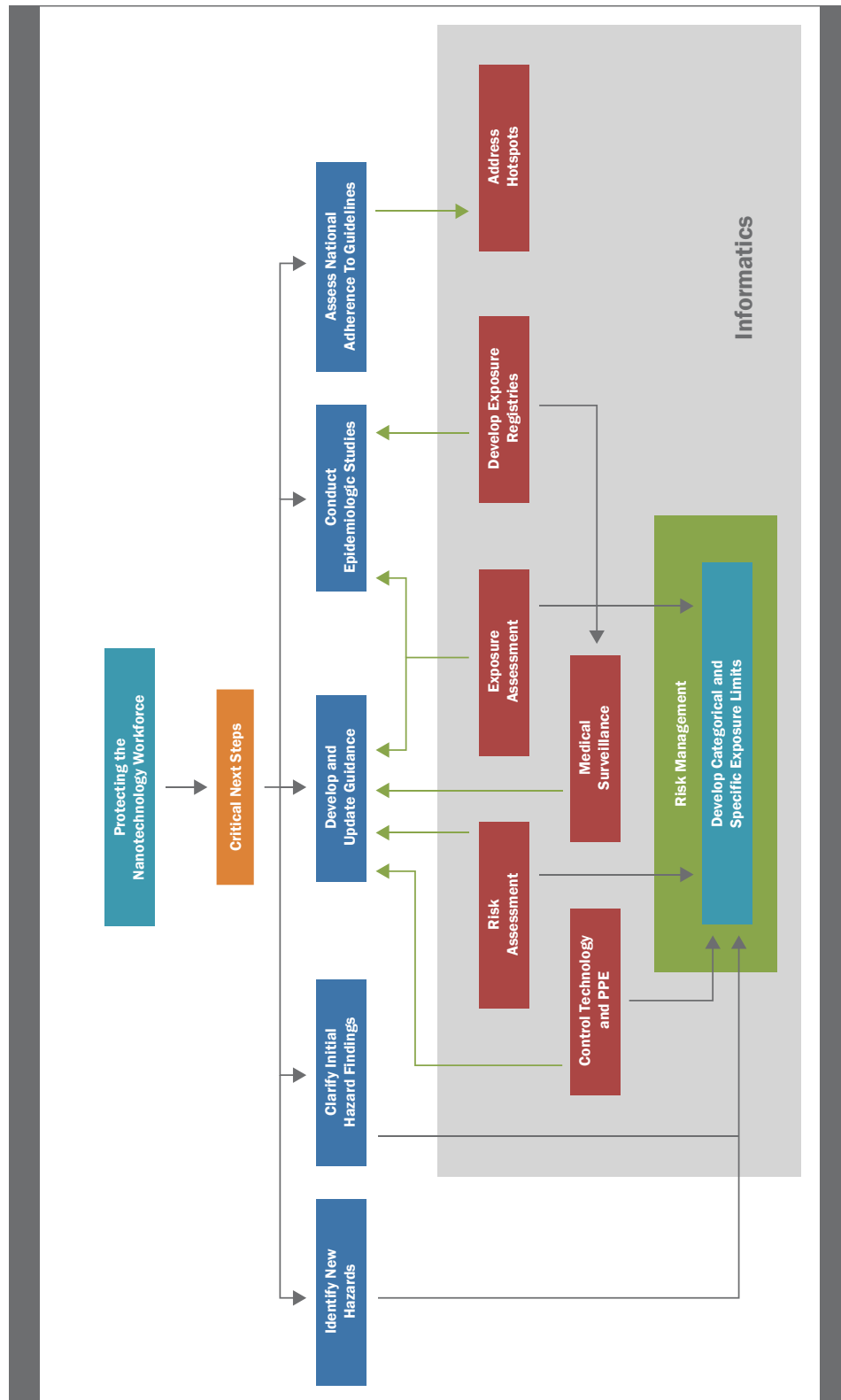

Figure 41. Anticipated focus of NIOSH NTRC nanomaterial research, FY2013–FY2016.

## 6 References

- Birch ME, Ku B-K, Evans DE, Ruda-Eberenz [2011]. Exposure and emissions monitoring during carbon nanofiber production. Part I: elemental carbon and iron-soot aerosols. *Ann Occup Hyg* 55(9):1016–1036.
- Birch ME [2011]. Exposure and emissions monitoring during carbon nanofiber production—part II: polycyclic aromatic hydrocarbons. *Ann Occup Hyg* 55(9):1037–1047.
- Burdorf A, Viikari-Juntura E [2007]. Bibliometric analysis of the Scandanavian Journal of Work, Environment & Health—results from the past 10 years. *Scan J Work Environ Health* 33(4):318–319.
- Dahm MM, Evans DE, Schubauer-Berigan MK, Birch ME, Fernback JE [2011]. Exposure assessment in carbon nanotube and nanofiber primary and secondary manufacturers. *Ann Occup Hyg* [doi:10.1093/annhyg/mer110].
- Evans DE, Ku BK, Birch ME, Dunn KH [2010]. Aerosol monitoring during carbon nanofiber production: mobile direct-reading sampling. *Ann Occup Hyg* 54(5):514–531.
- Evans DE, Turkevich LA, Roettgers CT, Deye GJ, Baron PA [2012]. Dustiness of fine and nanoscale powders. *Ann Occup Hyg* [in press].
- Gao P, Jaques PA, Hsiao T-C, Shepherd A, Eimer BC, Yang M, Miller A, Gupta B, Ronald Shaffer R [2011]. Evaluation of nano- and submicron particle penetration through ten nonwoven fabrics using a wind-driven approach. *J Occup Environ Hyg* 8(1):13–22.
- Gehanno JF, Takahashi K, Darmoni S, Weber J [2007]. Citation classics in occupational medicine journals. *Scand J Work Environ Health* 33(4):245–251.
- Howard J, Murashov V [2009]. National nanotechnology partnership to protect workers. *J Nanopart Res* 11(7):1673–1683.
- Kagan VE, Tyurina YY, Tyurin VA, Konduru NV, Potapovich AI, Osipov AN, Kisin ER, Schwegler-Berry D, Mercer RR, Castranova V, Shvedova AA [2006]. Direct and indirect effects of single walled carbon nanotubes on RAW 264.7 macrophages: role of iron. *Toxicol Lett* 165:88–100.
- Kostoff RN, Murday JS, Lau CGY, Tolles WM [2009]. Seminal nanotechnology literature: A review. *Journal of Nanoscience and Nanotechnology* 9(11):6239–6270.
- Lekus D, Lifset R, Rejeski D [2006]. Nanotechnology startup concerns, information needs, and opportunities to proactively address environmental, health and social issues: focus on



firms in Connecticut and New York. Masters Degree Project, Yale University, July [[http://www.nanotechproject.org/process/files/2717/87\\_nanotech\\_startup\\_study\\_ct\\_and\\_ny.pdf](http://www.nanotechproject.org/process/files/2717/87_nanotech_startup_study_ct_and_ny.pdf)].

Li Z, Hulderman T, Salmen R, Chapman R, Leonard S, Young S, Shvedova A, Luster M, Simeonova P [2007]. Cardiovascular effects of pulmonary exposure to single-wall carbon nanotubes. *Environ Health Perspect* 115(3):77–82.

Lo LM, Dunn KH, Hammond D, Almaguer D, Bartholomew I, Topmiller J, Tsai CSJ, Ellenbecker M, Huang CC [2011]. Evaluation of engineering controls for manufacturing nanofiber sheets and yarns. Cincinnati, OH: U.S. Department of Health and Human Services, Centers for Disease Control and Prevention, National Institute for Occupational Safety and Health, DHHS (NIOSH) Report No. EPHB 356–11a.

MacRoberts MH, MacRoberts BR [1988]. Problems of citation analysis: a critical review. *J Am Soc Inf Sci* 40:342–349.

Maynard AD, Baron PA, Foley M, Shvedova AA, Kisin ER, Castranova V [2004]. Exposure to carbon nanotube material during the handling of unrefined single walled carbon nanotube material. *J Toxicol Environ Health Part A* 67:87–107.

McKinney W, Chen B, Frazer D [2009]. Computer controlled multi-walled carbon nanotube inhalation exposure system. *Inhal Toxicol* 21(12):1053–1061.

Methner, MM, Birch E, Evans DE, Ku B-K, Crouch K, Hoover M, Mazzuckelli L (Ed) [2007]. Identification and characterization of potential sources of worker exposure to carbon nanofibers during polymer composite laboratory operations. *J Occup Environ Hyg* 4(12):D125–D130.

Methner MM, Old L (Ed.) [2008]. Engineering case study: effectiveness of local exhaust ventilation in controlling engineered nanomaterial emissions during reactor cleanout operations. *J Occup Environ Hyg* 5(6):D63–D69.

Methner MM, Hodson L, Geraci C [2010]. Nanoparticle emission assessment technique (NEAT) for the identification and measurement of potential exposure to engineered nanomaterials: Part A. *J Occup Environ Hyg* 7:127–132.

Methner MM [2010]. Effectiveness of a custom-fitted flange and LEV system in controlling the release of nano-scale metal oxide particulate. *Int J Occup Environ Health* 16:475–487.

Murashov V, Howard J [2008]. The U.S. must help set international standards for nanotechnology. *Nature Nanotechnol* 3:635–636.

NIOSH [2009a]. Strategic plan for NIOSH nanotechnology research and guidance. Cincinnati, Ohio: U.S. Department of Health and Human Services, Centers for Disease Control and Prevention, National Institute for Occupational Safety and Health, Publication No. 2010–105.

- NIOSH [2009b]. Approaches to safe nanotechnology: managing the safety and health concerns associated with engineered nanomaterials. Cincinnati, Ohio: U.S. Department of Health and Human Services, Centers for Disease Control and Prevention, National Institute for Occupational Safety and Health, Publication No. 2010–125.
- NIOSH [2009c]. Current intelligence bulletin 60: interim guidance for medical screening and hazard surveillance for workers potentially exposed to engineered nanomaterials. Cincinnati, Ohio: U.S. Department of Health and Human Services, Centers for Disease Control and Prevention, National Institute for Occupational Safety and Health, Publication No. 2009–116.
- NIOSH [2011]. Current intelligence bulletin 63: occupational exposure to titanium dioxide. Cincinnati, Ohio: U.S. Department of Health and Human Services, Centers for Disease Control and Prevention, National Institute for Occupational Safety and Health, Publication No. 2011–160.
- NIOSH [2012]. General safe practices for working with engineered nanomaterials in research laboratories. Cincinnati, Ohio: U.S. Department of Health and Human Services, Centers for Disease Control and Prevention, National Institute for Occupational Safety and Health, Publication No. 2012–147.
- Rengasamy S, King W, Eimer B, Shaffer R [2008]. Filtration performance of NIOSH-approved N95 and P100 filtering facepiece respirators against 4–30-nanometer-size nanoparticles. *J Occup Environ Hyg* 5:556–564.
- Rengasamy S, Eimer B [2011]. Total inward leakage of nanoparticles through filtering facepiece respirators. *Ann Occup Hyg* 55:253–263.
- Rengasamy S, Eimer B [2012]. Nanoparticle filtration performance of NIOSH certified particulate air purifying filtering facepiece respirators: evaluation by light scattering photometric and particle number-based test methods. *J Occup Environ Hyg* 9(2):99–109 [DOI: 10.1080/18459624.2011.642703].
- Rengasamy S, Eimer B [2012]. Nanoparticle penetration through filter media and leakage through face seal interface of N95 filtering facepiece respirators. *Ann Occup Hyg*, Jan 31 [DOI:10.1093/annhyg/mer122].
- Roco MC, Mirkin CA, Hersam MC [2010] Nanotechnology research directions for societal needs in 2020: retrospective and outlook. Arlington, VA: National Science Foundation [<http://wtcec.org/nano2/>].
- Sarli CG, Dubinsky EK, Holmes KL [2010]. Beyond citation analysis: a model for assessment of research impact. *J Med Libr Assoc* 98(1):17–23.
- Schubauer-Berigan MK, Dahm MM, Yencken MS [2011]. Engineered carbonaceous nanomaterials manufacturers in the United States: workforce size, characteristics and feasibility of epidemiologic studies. *J Occup Environ Med* 53(6 Suppl):S62–S67.





- Schulte PA, Salamanca-Buentello F [2007]. Ethical and scientific issues of nanotechnology in the workplace. *Environ Health Perspect* 115:512.
- Schulte PA, Geraci CL, Zumwalde R, Hoover M, Castranova V, Kuempel E, Murashov V, Vainio H, Savolainen K [2008]. Sharpening the focus on occupational safety and health of nanotechnology in the workplace. *Scand J Work Environ Health* 34(6):471–478.
- Schulte PA, Schubauer-Berigan MK, Mayweather C, Geraci CL, Zumwalde R, McKernan JL [2009]. Issues in the development of epidemiologic studies of workers exposed to engineered nanomaterials. *J Occup Env Med* 51:323–335.
- Schulte PA, Murashov M, Zumwalde R, Kuempel E, Geraci CL [2010]. Occupational exposure limits for nanomaterials: state of the art. *J Nanopart Res* 12:1971–1987.
- Schulte PA, Trout D, Hodson L [2011]. Introduction to nanomaterials and worker health: medical surveillance, exposure registries, and epidemiologic research. *JOEM* 53(6S):1.
- Schulte PA, Kuempel E, Zumwalde R, Geraci CL, Schubauer-Berigan M, Castranova V, Hodson L, Murashov V, Dahm MM, Ellenbecker M [2012]. Focused actions to protect carbon nanotube workers. *Am J Ind Med* [DOI10.1002/ajim.22028].
- Shaffer R, Rengasamy S [2009]. Respiratory protection against nanoparticles: a review. *J Nanopart Res* 11:1661–1672.
- Shvedova AA, Castranova V, Kisin E, Schwegler-Berry D, Murray AR, Gandelsman VZ, Maynard A, Baron P [2003]. Exposure to carbon nanotube material: assessment of nanotube cytotoxicity using human keratinocyte cells. *J Toxicol Environ Health* 66(Part A):1901–1918.
- Shvedova A, Kisin E, Mercer R, Murray A, Johnson VJ, Potapovich A, Tyurina Y, Gorelic O, Arepalli S, Schwegler-Berry D, Antonini J, Evans DE, Ku B-K, Ramsey D, Maynard A, Kagan VE, Castranova V, Baron P [2005]. Unusual inflammatory and fibrogenic pulmonary responses to single walled carbon nanotubes in mice. *Am J Physiol: Lung Cell Mol Physiol* 289:L698–L708.
- Shvedova AA, Potapovich AL, Osipov AN, Tyurina YY, Kisin E, Schwegler-Berry D, Mercer RR, Castranova V, Kagan VE [2006]. Oxidative interactions of single walled carbon nanotubes with RAW 264.7 macrophages: role of iron. *Toxicology* 90(1):A1557.
- Smith DR [2007]. Historical development of journal impact factors and its relevance for occupational health. *Ind Health* 45:730–742.
- U.S. Department of Commerce [2007]. Barriers to nanotechnology commercialization: final report. September. [<http://www.ntis.gov/pdf/Report-BarrierNanotechnologyCommercialization.pdf>].
- U.S. Government Accountability Office [2012]. Nanotechnology improved performance information needed for environmental, health, and safety research GAO-12-427, May 21, 2012 [<http://www.gao.gov/products/GAO-12-427>].

# Project-Specific Progress Reports

## APPENDIX A

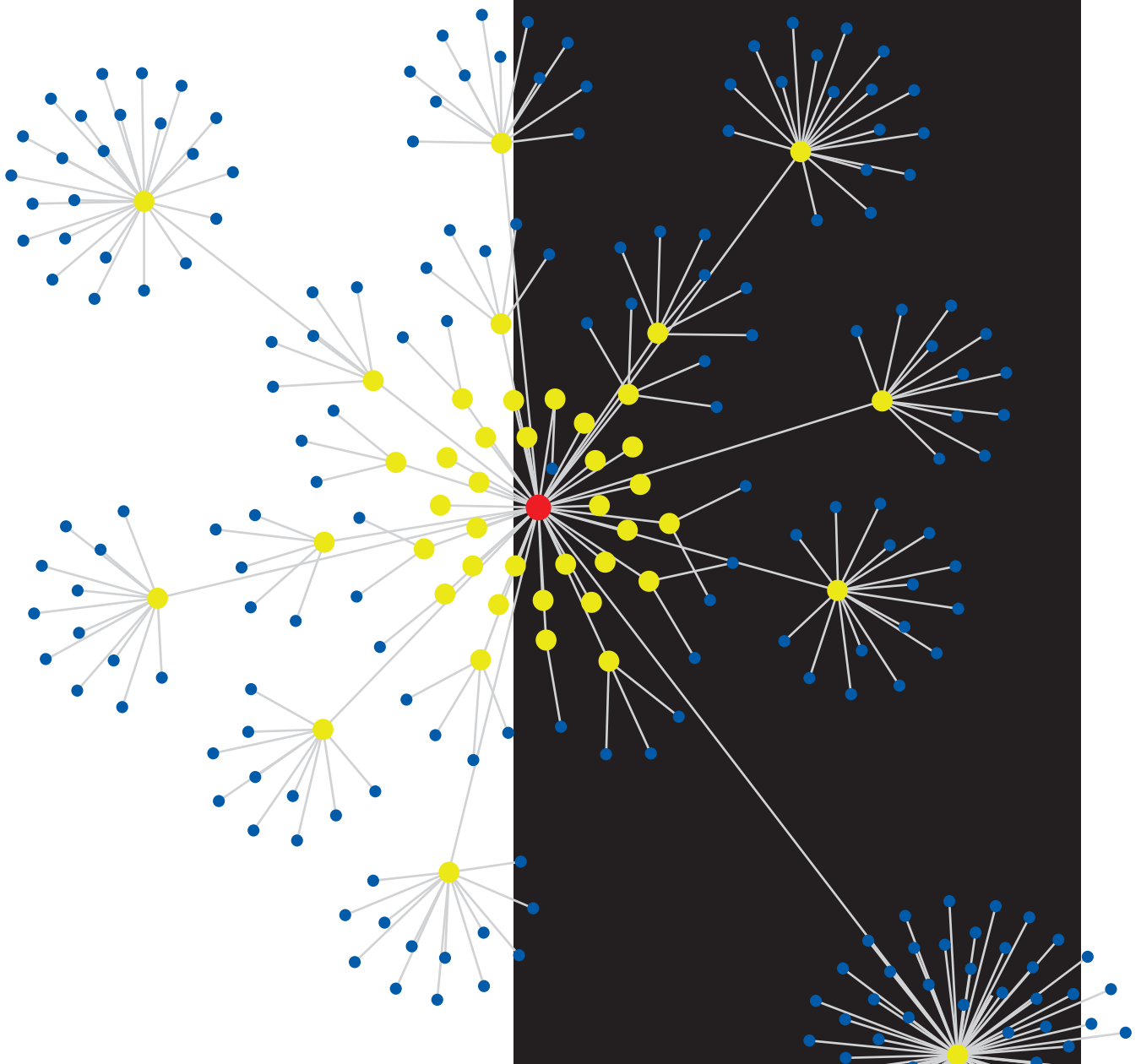

**Summary of 69 NIOSH Nanotechnology Research Projects, 2004–2011**

<b>Project number</b>	<b>Project title</b>	<b>Principle investigator</b>	<b>Project duration</b>
1	Nanotechnology Research Center Coordination	Charles Geraci, PhD	FY2005–2012
2	Nanotechnology Safety and Health Research Coordination (Nanotoxicology)	Vincent Castranova, PhD	FY2004–2008
3	Development of New Research in Occupational Health (Nanotoxicology)	Vincent Castranova, PhD	FY2009–2012
4	Systemic Microvascular Dysfunction: Effects of Ultrafine vs. Fine Particles	Vincent Castranova, PhD	FY2006–2010
5	Particle Surface Area as a Dose Metric	Vincent Castranova, PhD	FY2004–2008
6	Role of Carbon Nanotubes in Cardiovascular and COPD-Related Diseases	Aaron Erdely, PhD	FY2004–2010
7	Investigations of Multi-Walled Carbon Nanotube Toxicity	Dale Porter, PhD	FY2007–2011
8	Toxicological Effects of Aerosolized MWCNT	Dale Porter, PhD	FY2010–2012
9	Pulmonary Toxicity of Metal Oxide Nanospheres and Nanowires	Dale Porter, PhD	FY2007–2011
10	WC-Co Nanoparticles in Initiating Angiogenesis by Reactive Oxygen Species	Min Ding, PhD	FY2008–2011
11	Evaluation of the Pulmonary Deposition and Translocation of Nanomaterials	Robert Mercer, PhD	FY2006–2011

(continued)

**Summary of 69 NIOSH Nanotechnology Research Projects, 2004–2011 (Continued)**

<b>Project number</b>	<b>Project title</b>	<b>Principle investigator</b>	<b>Project duration</b>
12	Occupational Exposures and Potential Neurological Risks	Krishan Sriram, PhD	FY2008–2012
13	Lung Effects of Resistance Spot Welding Using Adhesives	James Antonini, PhD	FY2007–2010
14	Neurotoxicity after Pulmonary Exposure to Welding Fumes	James Antonini, PhD	FY2007–2010
15	Welding Fume and Cardiovascular Dysfunction	Hong Kan	FY2010–2013
16	Potential Aneuploidy Following Exposure to Carbon Nanotubes	Linda Sargent, PhD	FY2007–2010
17	Nanoparticle Properties and Mechanisms Causing Lung Fibrosis	Liyang Wang Rojanasakul, PhD	FY2008–2012
18	Pulmonary Toxicity of Carbon Nanotube Particles	Anna Shvedova, PhD	FY2004–2008
19	Assessment of Engineered Nanomaterials on Respiratory Immunity	Anna Shvedova, PhD	FY2009–2012
20	Dermal Toxicity of Nanotube Particles	Anna Shvedova, PhD	FY2005–2010
21	Bioassay Screen of Lung Toxicity of Silver Nanoparticles	Jenny Roberts, PhD	FY2010–2012
22	Specific Biomarkers for Unusual Toxicity of Nanomaterials	Liyang Wang Rojanasakul, PhD	FY2007–2009
23	Pulmonary Toxicity of Diesel Exhaust Particles	Jane Ma, PhD	FY2003–2008

(continued)

**Summary of 69 NIOSH Nanotechnology Research Projects, 2004–2011 (Continued)**

<b>Project number</b>	<b>Project title</b>	<b>Principle investigator</b>	<b>Project duration</b>
24	Induction of Lung Fibrosis by Cerium Oxide in Diesel Exhaust	Jane Ma, PhD	FY2009–2012
25	Potential Effects of Silicon-based Nanowires on Lung Toxicity	Stephen Leonard, PhD	FY2008–2012
26	Workplace Exposure, Inflammation and Cardiovascular Toxicity	Aaron Erdely, PhD	FY2010–2014
27	Cardiovascular Toxicity Assessment of Subchronic Inhalation Exposure to Fullerene C60	Aaron Erdely, PhD	FY2009–2010
28	Cell-based Assessment for Iron Nanoparticle-Induced Health Risks	Yong Qian, PhD	FY2008–2011
29	Assessment of Carbonaceous Materials on Mutagenicity	Anna Shvedova, PhD	FY2008–2009
30	Durability of Nanoscale Cellulose Fibers in Artificial Human Lung Fluids	Aleksandr Stefaniak, PhD	FY2011–2012
31	Osteopontin and Carbon Nanotubes	Petia Simeonova, PhD (deceased)	FY2004–2009
32	Determination of Diameter Distribution for Carbon Nanotubes by Raman Spectroscopy	Madalina Chirila, PhD	FY2007–2009
33	Inhalation Facility Support	Teh-Hsun B. Chen, PhD	FY2000–2015
34	Generation and Characterization of Nanoparticles	Bon-Ki Ku, PhD	FY2004–2008

(continued)

**Summary of 69 NIOSH Nanotechnology Research Projects, 2004–2011 (Continued)**

<b>Project number</b>	<b>Project title</b>	<b>Principle investigator</b>	<b>Project duration</b>
35	Dustiness of Nanomaterials	Douglas Evans, PhD	FY2007–2010
36	Measurement of Nanoscale Carbonaceous Aerosols	M. Eileen Birch, PhD	FY2007–2008
37	Nanoaerosol Monitoring Methods	M. Eileen Birch, PhD	FY2006–2012
38	Workplace Monitoring of Carbon Nanofibers/Nanotubes	M. Eileen Birch, PhD	FY2009–2012
39	Real time Instrument for Nanoaerosol Exposure Measurement	Pramod Kulkarni, DSc	FY2008–2011
40	Nanoparticle Reference Materials for Health Protection	Aleksandr Stefaniak, PhD	FY2007–2009
41	International Coordination of Nanoscale Reference Materials	Aleksandr Stefaniak, PhD	FY2010–2012
42	A Standard Method for Determining Airborne Nanoparticle Size	Aleksandr Stefaniak, PhD	FY2009–2011
43	Calm Air Chamber and Wind Tunnel Evaluation of Personal Aerosol Samplers for Nanoparticle Exposure Assessment	Terri Pearce, PhD	FY2008–2010
44	Efficacy of NIOSH Method 0600 for Fine and Ultrafine Titanium Dioxide	Terri Pearce, PhD	FY2010–2011
45	Ultrafine TiO <sub>2</sub> Surface and Mass Concentration Sampling Method	Aleksandr Stefaniak, PhD	FY2007–2011

(continued)

**Summary of 69 NIOSH Nanotechnology Research Projects, 2004–2011 (Continued)**

<b>Project number</b>	<b>Project title</b>	<b>Principle investigator</b>	<b>Project duration</b>
46	Development and Evaluation of Nanoaerosol Surface Area Measurement Methods	Bon-Ki Ku, PhD	FY2009–2010
47	Respiratory Deposition of Airborne Carbon Nanotubes	Pramod Kulkarni, PhD	FY2010–2012
48	Exposure Potential from Use of Nanomaterial-Enabled Consumer Products	Aleksandr Stefaniak, PhD	FY2009–2012
49	Ultrafine Aerosols from Diesel-Powered Equipment	Aleksandar Bugarski, PhD	FY2004–2008
50	Titanium Dioxide and Other Metal Oxides Exposure Assessment Study	Brian Curwin, PhD	FY2006–2010
51	Field Research Team	Charles Geraci, PhD	FY2006–2012
52	Factors Affecting Exposure to Engineered Nanomaterials	M. Abbas Virji, PhD	FY2010–2012
53	Assessing the Feasibility of Industrywide Exposure and Epidemiology Studies of Workers Exposed to Engineered Nanomaterials—Phase I	Mary Schubauer-Berigan, PhD	FY2008–2009
54	Assessing the Feasibility of Industrywide Exposure and Epidemiology Studies of Workers Exposed to Engineered Nanomaterials—Phase II	Matthew Dahm, MPH	FY2010–2011
55	Nanoparticles—Dosimetry and Risk Assessment	Eileen Kuempel, PhD	FY2005–2012
56	Titanium Dioxide Quantitative Risk Assessment	David Dankovic, PhD	FY2005–2011

(continued)



**Summary of 69 NIOSH Nanotechnology Research Projects, 2004–2011 (Continued)**

<b>Project number</b>	<b>Project title</b>	<b>Principle investigator</b>	<b>Project duration</b>
57	Engineering Controls for Nanomaterial Handling	Li-Ming Lo, PhD	FY2010–2012
58	Applying PtD to the Safe Handling of Engineered Nanomaterials	Donna Heidel, CIH	FY2009–2013
59	Penetration of Nanoparticles through Respirators/ Development of Respirator Filtration Test Methods	Samy Rengasamy, PhD	FY2005–2011
60	Nanoparticle Penetration through Protective Clothing	Pengfei Gao, PhD	FY2009–2010
61	Respirator Performance Against Engineered Nanoparticles Under Laboratory and Workplace Settings	Ziqing Zhuang, PhD	FY2011–2015
62	Development of Personal Protective Equipment Ensemble Test Methods	Pengfei Gao, PhD	FY2005–2012
63	Explosibility and Flammability of Carbon Nanotubes	Leonid Turkevich, PhD	FY2010–2013
64	Current Intelligence Bulletin: Carbon Nanotubes and Carbon Nanofibers	Eileen Kuempel, PhD	FY2009–2014
65	Assessing the Utility of Control Banding in the U.S.	T.J. Lentz, PhD	FY2004–2012
66	Web-Based Nanoparticle Information Library Implementation	Arthur Miller, PhD	FY2004–2008
67	Nanoparticles in the Workplace and Metrics for Field and Toxicity Studies	Mark Hoover, PhD	FY2004–2011

(continued)

**Summary of 69 NIOSH Nanotechnology Research Projects, 2004–2011 (Continued)**

<b>Project number</b>	<b>Project title</b>	<b>Principle investigator</b>	<b>Project duration</b>
68	Global Harmonization of Exposure Measurement and Exposure Mitigation Approaches for Nanomaterials	Vladimir Murashov, PhD	FY2006–2011
69	New Sensor Technology Development for Filter Respirator Cartridge End-of-Service Life Indicators (ESLI)	Jay Snyder, MS	FY2002–2010

## Project 1: Nanotechnology Research Center Coordination

Principal Investigator: Charles Geraci, PhD

Project Duration: FY 2005–2012

**Critical Topic Areas:** (1) toxicity and internal dose, (2) measurement methods, (3) exposure assessment, (4) epidemiology and surveillance, (5) risk assessment, (6) engineering controls and personal protective equipment, (7) fire and explosion safety, (8) recommendations and guidance, (9) communication and information, and (10) applications.

### Accomplishments and Research Findings

- Coordinated the NIOSH Nanotechnology Research Program across 10 critical areas identified in the strategic research plan developed by the NTRC to identify and prioritize nanotechnology research.
- Sponsored and provided strategic direction to the Nanotechnology Field Research Team, which conducted 31 site visits to 26 sites in the reporting period.
- Fostered collaboration among investigators across the entire NIOSH Nanotechnology Research Program.



Metal oxide reactor cleanout



- Developed and maintained successful interagency agreements with
  - Occupational Safety and Health Administration
  - Consumer Product Safety Commission
  - National Toxicology Program
- Fostered collaboration in nanotechnology research with
  - AIHA
  - ASSE
  - NSC
  - U.S. Air Force
  - U.S. Army
  - NASA
  - DOE
  - International Alliance for NanoEHS Harmonization
  - University of Massachusetts, Lowell
  - The Ohio State University
  - University of Dayton Research Institute
  - SUNY, Albany College of Nanoscale Science Engineering (CNSE)
- Represented NIOSH on several national and international working groups on nanotechnology, safety, and health.
- Presented overviews of the NIOSH Nanotechnology Research Program to numerous organizations.
- Provided briefings to the President's Council of Advisors on Science and Technology.

### Publications and Abstracts

- Hoover MD, Stefaniak AB, Day GA, Geraci CL [2007]. Exposure assessment considerations for nanoparticles in the workplace. In: Monteiro-Riviere NA, Tran CL, eds. *Nanotoxicology: characterization, dosing, and health effects*. New York: Informa Healthcare USA Inc., pp.71–83.
- Kuempel ED, Geraci CL, Schulte PA [2007]. Risk assessment approaches and research needs for nanomaterials: an examination of data and information from current studies. In: Simeonova PP, Opopol N, Luster MI, eds. *Nanotechnology: toxicological issues and environmental safety; NATO security through science series book*. New York: Springer-Verlag, pp.119–145.
- Murashov V, Howard [2007]. Occupational health and nanotechnology. *J Applied Biosafety* 12(3):43–56.

- Schulte PA, Salamanca-Buentello F [2007]. Ethical and scientific issues of nanotechnology in the workplace. *Environ Health Perspect* 115:5–12.
- NIOSH [2008]. Safe nanotechnology in the workplace: an introduction for employers, managers, and safety and health professionals. Cincinnati, OH: U.S. Department of Health and Human Services, Centers for Disease Control, National Institute for Occupational Safety and Health, National Institute for Occupational Safety and Health, DHHS (NIOSH) Publication No. 2008–112.
- NIOSH [2008]. The nanotechnology field research team update. Cincinnati, OH: U.S. Department of Health and Human Services, Centers for Disease Control, National Institute for Occupational Safety and Health, National Institute for Occupational Safety and Health, DHHS (NIOSH) Publication No. 2008–120.
- NIOSH [2008]. NIOSH nanotechnology field research effort fact sheet. Cincinnati, OH: U.S. Department of Health and Human Services, Centers for Disease Control, National Institute for Occupational Safety and Health, DHHS (NIOSH) Publication No. 2008–121.
- NIOSH [2008]. NIOSH nanotechnology metal oxide particle exposure assessment study. Cincinnati, OH: U.S. Department of Health and Human Services, Centers for Disease Control, National Institute for Occupational Safety and Health, National Institute for Occupational Safety and Health, DHHS (NIOSH) Publication No. 2008–122.
- NIOSH [2008]. Draft strategic plan for NIOSH nanotechnology research: filling the knowledge gaps. Cincinnati, OH: U.S. Department of Health and Human Services, Centers for Disease Control, National Institute for Occupational Safety and Health, National Institute for Occupational Safety and Health, February 2008.
- Schulte PA, Geraci CL, Zumwalde RD, Hoover MD, Kuempel ED [2008]. Occupational risk management of nanoparticles. *J Occup Environ Hyg* 5(4):239–249.
- Schulte PA, Trout D, Zumwalde R, Kuempel E, Geraci CL, Castranova V, Mundt D, Mundt K, Halperin W [2008]. Options for occupational health surveillance of workers potentially exposed to engineered nanoparticles: state of the science. *J Occup Med* 50(5):517–526.
- Schulte PA, Geraci CL, Zumwalde R, Hoover M, Castranova V, Kuempel E, Murashov V, Vainio H, Savolainen K [2008]. Sharpening the focus on occupational safety and health of nanotechnology. *Scand J Work Environ Health* 34:471–478.
- Murashov V, Howard J [2008]. The U.S. must help set international standards for nanotechnology. *Nature Nanotech* 3:635–636.
- NIOSH [2009]. Interim guidance for medical screening and hazard surveillance for workers potentially exposed to engineered nanoparticles. Cincinnati, OH:



U.S. Department of Health and Human Services, Centers for Disease Control, National Institute for Occupational Safety and Health, National Institute for Occupational Safety and Health, DHHS (NIOSH) Publication No. 2009–116.

- NIOSH [2009]. Approaches to safe nanotechnology: managing the health and safety concerns with engineered nanomaterials. Cincinnati, OH: U.S. Department of Health and Human Services, Centers for Disease Control, National Institute for Occupational Safety and Health, National Institute for Occupational Safety and Health, DHHS (NIOSH) Publication No. 2009–125.
- NIOSH [2009]. Strategic plan for NIOSH nanotechnology research and guidance. Cincinnati, OH: U.S. Department of Health and Human Services, Centers for Disease Control, National Institute for Occupational Safety and Health, National Institute for Occupational Safety and Health, Publication No. 2010–105.
- Schulte PA, Schubauer-Berigan MK, Mayweather C, Geraci CL, Zumwalde R, McKernan JL [2009]. Issues in the development of epidemiologic studies of workers exposed to engineered nanoparticles. *J Occup Environ Med* 51(3):323–335.
- Murashov V, Howard J [2009]. Letter to the editor. *Nature Nanotech* 4:205–206.
- Murashov V, Howard J [2009]. Essential features for proactive risk management of nanotechnology. *Nature Nanotech* 4(8):467–470.
- Howard J, Murashov V [2009]. National Nanotechnology Partnership to Protect Workers. *J Nanoparticle Res* 11(7):1673–1683.
- Schulte PA, Schubauer-Berigan MK, Mayweather C, Geraci CL, Zumwalde R, McKernan JL [2009]. Issues in the development of epidemiologic studies of workers exposed to engineered nanoparticles. *J Occup Environ Med* 51:323–335.
- Schulte PA [2010]. Nanoparticles. In: Identification of research needs to resolve the carcinogenicity of high-priority IARC carcinogens. IARC Technical Publication No. 42. Lyon, France: IARC.
- Trout DB, Schulte PA [2010]. Medical surveillance, exposure registries, and epidemiologic research for workers exposed to nanomaterials. *Toxicology* 269:128–135.



NTRC Researchers at 2012 bi-annual meeting



- Schulte PA, Murashov V, Zumwalde R, Kuempel ED, Geraci CL [2010]. Occupational exposure limits for nanomaterials: state of the art. *J Nanoparticle Res* 12(6):1971–1987.
- Geraci CL, Castranova V [2010]. Challenges in assessing nanomaterial toxicology: a personal perspective. *Wiley Interdiscip Rev Nanomed Nanobiotechnol* 2(6):569–577.
- Ramachandran G, Ostraat M, Evans DE, Methner MM, O’Shaughnessy P, D’Arcy J, Geraci CL, Stevenson E, Maynard A, Rickabaugh K [2011]. A strategy for assessing workplace exposures to nanomaterials. *J Occup Environ Hyg* 8(11):673–685.
- Murashov V, Schulte P, Geraci C, Howard J [2011]. Regulatory approaches to worker protection in nanotechnology industry in the USA and European Union. *Ind Health* 49(3):280–296.
- Dankovic D, Kuempel E, Geraci C, Gilbert S, Rice F, Schulte P, Smith R, Sofge C, Wheeler M, Lentz TJ, Zumwalde R, Maynard A, Attfield M, Pinheiro G, Ruder A, Hubbs A, Ahlers H, Lynch D, Toraason M, Vallyathan V [2011]. Current intelligence bulletin 63: occupational exposure to titanium dioxide. Cincinnati, OH: U.S. Department of Health and Human Services, Public Health Service, Centers for Disease Control and Prevention, National Institute for Occupational Safety and Health, DHHS (NIOSH) Publication No. 2011–160.
- Brouwer D, Berges M, Fransman W, Virji A, Bello D, Hodson L, Gabriel S, Tielemans E [2011]. Harmonization of measurement strategies for the assessment of exposure to manufactured nano object: report of a workshop. *Ann Occup Hyg* 56(1):1–9.
- Schulte PA, Trout DB, Hodson LL [2011]. Nanomaterials and worker health: medical surveillance, exposure registries, and epidemiologic research [introduction to supplement]. *J Occup Environ Med* 53(6) (Suppl):S1–S2.
- Methner M, Beaucham C, Crawford C, Hodson L, Geraci C [2012]. Field application of the Nanoparticle Emission Assessment Technique (NEAT): task-based air monitoring during the processing of engineered nanomaterials (ENMs) at four facilities. *J Occup Environ Hyg* 9(9):543–555.
- Howard J [2011]. Dynamic oversight: implementation gaps and challenges. *J Nanoparticle Res* 13:1427–1434 (DOI 10.1007/s11051-011-0225-2).
- Eastlake A, Hodson L, Geraci C, Crawford C [2012]. A critical evaluation of material safety data sheets (MSDS) for engineered nanomaterials. *J Chem Health Safety* 19(5):1–8. (DOI 10.1016/j.jchas.2012.02.002).





## Invited Presentations

- Schulte PA [2005]. NIOSH Nanotechnology Research. Nanoparticle Occupational Health and Safety Workshop sponsored by the Massachusetts Toxics Use Reduction Institute and the Center for High-Rate Nonmanufacturing. Westborough, Massachusetts, December 2.
- Schulte PA [2005]. Panel member. Ethical and legal aspects of nanomaterials and environmental regulation. Materials Research Society Fall Meeting. Boston, Massachusetts, December 1.
- Kuempel E, Geraci C, Schulte P [2006]. Risk assessment approach, and research need for nanoparticles. NATO Advanced Research Workshop on Nanotechnology. Varna, Bulgaria, August 18.
- Schulte PA [2006]. Overview of conference. International Conference on Nanotechnology Occupational and Environmental Health and Safety: Research to Practice. Cincinnati, Ohio, December 5.
- Schulte PA [2007]. NIOSH Nanotechnology Program. Meeting of the Nano-Business Alliance. Washington, DC, January 30.
- Schulte PA [2007]. Nanotechnology: A progress report on understanding occupational safety and health issues. Woodrow Wilson International Center for Scholars. Washington DC, February 28.
- Schulte PA, Mundt D, Mundt K [2007]. Medical Surveillance and Nanotechnology Overview. Workshop on Occupational Health Surveillance and Nanotechnology Workers. Arlington, Virginia, April 17–18.
- Schulte PA [2007]. Occupational Safety and Health Issues in Nanotechnology. International Commission on Occupational Health. Milan, Italy, June 12.
- Schulte PA [2007]. Progress in addressing gaps in the occupational safety and health of nanotechnology. 3rd International Symposium on Nanotechnology and Environmental Health. Taipei, Taiwan, August 30.
- Schulte PA [2007]. Analysis of ethical issues of nanotechnology in the workplace. (Invited Presentation) 3rd International Symposium on Nanotechnology and Environmental Health. Taipei, Taiwan, August 31.
- Schulte PA [2007]. Interim guidance on medical monitoring of workers potentially exposed to engineered nanoparticles. US Nanotechnology Policy Coordinating Group on the NIOSH Current Intelligence Bulletin. Washington, DC, September 17.
- Schulte PA [2007]. Occupational Safety and Health Issues of Nanotechnology in the Workplace. Keynote address 2007 E&S Loss Control Executive Forum. Orlando, Florida, November 7.
- Schulte PA [2007]. Occupational Safety and Health Issues of Nanotechnology in the Workplace. Nanotechnology and Occupational Health and Safety Conference. Santa Barbara, California, November 15.

- Schulte PA [2007]. Current occupational safety and health issues of nanotechnology in the USA. European NanOSH Conference. Helsinki, Finland. December 3.
- Geraci CL [2007]. Nanotechnology: an overview of health and safety issues. Implications and applications. Ohio Safety Congress and Expo, Columbus, Ohio, March 20.
- Geraci CL [2007]. The NIOSH Nanotechnology Research Program: occupational implications and applications. General Electric nanotechnology summit, Miskayuna, New York, April 18.
- Geraci CL [2007]. Nanotechnology: using basic risk management concepts to address difficult questions. Society for Chemical Hazard Communication Spring Meeting, San Antonio, Texas, April 25.
- Geraci CL [2007]. The NIOSH Nanotechnology Research Program: occupational implications and applications. Northeastern University panel on nanotechnology and policy, Boston, Massachusetts, May 1.
- Geraci CL [2007]. Nanomaterials in the workplace: applying basic risk management principles. American Society of Safety Engineers webinar, May 15.
- Geraci CL [2007]. Nanotechnology: an international perspective from NIOSH. Education Safety Association of Ontario Annual Conference, Ontario, Canada, May 31.
- Geraci CL, Hoover MD [2007]. Exposure assessment and sampling issues for nanotoxicology and safe handling of nanoparticles in the workplace. American Industrial Hygiene Association Conference and Exposition, Roundtable 201. Toxicology and exposure assessment issues for nanotechnology: an update for industrial hygienists, Philadelphia, Pennsylvania, June 2–7.
- Geraci CL [2007]. One year later: an update of the NIOSH Nanotechnology Research Program. American Industrial Hygiene Association Conference and Exposition, Roundtable 218. Ask the experts: an update on the NIOSH Nanotechnology Research Program, Philadelphia, Pennsylvania, June 2–7.
- Geraci CL [2007]. Building OS&H capability in nanomaterial manufacturing: an example of “research to practice.” American Society of Safety Engineers Conference and Exposition, Orlando, Florida, June 25.
- Geraci CL [2007]. Meeting the challenge: an update of the NIOSH Nanotechnology Research Program. ORC Worldwide Occupational Safety and Health Joint Meeting, Washington, DC, August 8.
- Geraci CL, Methner MM, Dunn KH, Coe-Sullivan S [2007]. Occupational safety and health field study of workers potentially exposed to quantum dot nanomaterials. International Symposium on Nanotechnology: Occupational and Environmental Health, Taipei, Taiwan, August 29.



- Geraci CL [2007]. Occupational risk management for nanomaterials along the product life cycle. International Symposium on Nanotechnology: Occupational and Environmental Health, Taipei, Taiwan, September 1.
- Geraci CL [2007]. International collaboration opportunities in nanotechnology research. International Symposium on Nanotechnology: Occupational and Environmental Health, Taipei, Taiwan, September 1.
- Geraci CL [2007]. Progress in addressing the occupational safety and health concerns of nanotechnology. President's Council of Advisors on Science and Technology, briefing panel, Washington, DC, September 11.
- Geraci CL [2007]. Workplace risk management of nanomaterials: challenges and lessons learned. NanoTexas'07, Dallas, Texas, October 3.
- Geraci CL [2007]. Nanotechnology: the new workplace, industrial hygiene implications. Professional Conference on Industrial Hygiene, Louisville, Kentucky, October 17.
- Geraci CL [2007]. Nanotechnology: the new workplace. Nano 101 for the industrial hygienist. Professional Conference on Industrial Hygiene, Louisville, Kentucky, October 23.
- Geraci CL [2007]. The NIOSH Nanotechnology Research Program. Professional Conference on Industrial Hygiene, Louisville, Kentucky, October 23.
- Geraci CL [2007]. Nanotechnology: the new workplace. Workplace exposure assessment challenges. American College of Occupational Medicine State-of-the-Art Conference/International Conference on Health Care Worker Health, Vancouver, British Columbia, Canada, October 27.
- Geraci CL [2007]. Safe development of nanotechnology. Massachusetts governor's panel on nanotechnology, Office of Technical Assistance and Technology, Boston, Massachusetts, November 15.
- Geraci CL, Hoover MD [2007]. A risk assessment and control approach. Teleweb on nanotechnology health and safety: case studies in the occupational setting. American Conference of Governmental Industrial Hygienists, December 4.
- Hodson LL [2007]. Nanoparticles: NIOSH Nanoparticles Research Program. The Insurance Loss Control Association, Lexington, Kentucky, October 31.
- Hoover MD, Geraci CL [2008]. Nanotoxicology issues for assessing and managing occupational exposure risks for nanoparticles in the workplace. American Industrial Hygiene Association Distance Learning Program, January 31.
- Geraci CL [2008]. Occupational safety and health issues and nanotechnology. Education Resource Committee program directors meeting, Galveston, Texas, February 10.
- Schulte PA [2008]. Occupational safety and health issues and nanotechnology. Food and Drug Law meeting, Washington, DC, February 18 and 19.

- Geraci CL [2008]. Progress in addressing the occupational safety and health concerns of nanotechnology. Meeting with Lockheed Martin, Baltimore, Maryland, February 1.
- Geraci CL [2008]. Progress in addressing the occupational safety and health concerns of nanotechnology. Meeting with the New Jersey Technology Council, Rutgers University, Camden, New Jersey, March 4.
- Geraci CL, Methner MM, Pearce TA, Hodson LL [2008]. Nanotechnology for industrial hygienists. American Industrial Hygiene Association—Central Ohio section meeting, Columbus, Ohio, April 22.
- Geraci CL [2008]. Nanotechnology and occupational safety and health: What do we know? SSHA Annual High Technology Environmental Health and Safety Symposium, Portland, Oregon, March 27.
- Geraci CL, Hoover MD, Heidel DS, Pearce TA, Methner MM, Hodson LL [2008]. Nanoparticles in the workplace: assessing and managing risks. American Industrial Hygiene Association Conference and Exposition, Minneapolis, Minnesota, May 31–June 5.
- Geraci CL [2008]. Update on NIOSH research on the measurement of nanoparticles in the workplace. American Industrial Hygiene Association Conference and Exposition, Roundtable 218. Ask the experts: an update on NIOSH Nanotechnology Research Program, Minneapolis, Minnesota, May 31–June 5.
- Geraci CL [2008]. NIOSH guidance on nanotechnology: protecting our workers' environmental, health, and safety issues in nanomaterials workshop. Meeting sponsored by The American Ceramic Society/National Institute of Standards and Technology, Gaithersburg, Maryland, June 8–10.
- Geraci CL [2008]. Nanotechnology and occupational safety and health: What do we know? International Conference on Nanotechnology for the Forest Products Industry, St. Louis, Missouri, June 25.
- Geraci CL [2008]. The NIOSH nanotechnology field research team—a brief summary and update of activities. DOE nanoscale science research centers symposium: safe handling of engineered nanoscale materials, teleseminar to Argonne, July 9.
- Geraci CL [2008]. Engineering Controls: The Continuum of Prevention through Design, Control Banding, and Engineering Controls. OECD Working Party on Manufactured Nanomaterials Workshop on Exposure Assessment and Exposure Mitigation, Frankfurt, Germany, October 20.
- Geraci CL [2008]. Nanotechnology: real world challenges for the industrial hygienist. Professional Conference on Industrial Hygiene. Tampa, Florida, November 11.



- Geraci CL [2008]. Nanotechnology: Real world challenges for the industrial hygienist. California Industrial Hygiene Council, San Diego, California, December 8.
- Methner MM, Hodson LL, Geraci CL [2008]. Nanotechnology Emission Assessment Technique (NEAT) used by NIOSH for Identifying Sources and Releases of Engineered Nanoparticles. Ohio Valley American Industrial Hygiene Association section, West Chester, Ohio, December 16.
- Hodson LL [2008]. Workplace exposure assessment and risk management practices for nanomaterials. The Ohio Safety Congress and Expo, Columbus, Ohio, April 3.
- Hodson LL [2008]. The NIOSH field research team—a brief summary and update of activities. U.S. Air Force (USAF) workshop on biological interaction of engineered nanoparticles, Wright Patterson AFB, Dayton, Ohio, June 24.
- Hodson LL [2008]. NIOSH Nanotechnology Research Program. American Industrial Hygiene Association, Indiana section meeting, Indianapolis, Indiana, July 9.
- Hodson LL [2008]. Nanoparticles—NIOSH Nanoparticle Research Program. The Edison Electric Institute spring occupational health and safety conference, Louisville, Kentucky, April 29.
- Schulte PA [2008]. Occupational Safety and Health Issues and Nanotechnology (Keynote Address). Institute of Environmental Sciences and Technology. Bloomington, Illinois, May 6.
- Schulte PA [2008]. Occupational Safety and Health Issues and Nanotechnology 1st Annual Conference on Nanotechnology Law, Regulation and Policy. Washington, DC, February 29.
- Schulte PA [2008]. Prevention through Design National Initiative. ORC Worldwide quarterly occupational safety and health meeting. Washington, DC, February 7.
- Schulte PA [2008]. Occupational Safety and Health Issues in Nanotechnology (Keynote Address). Northwest Occupational Health Conference. Seattle, Washington, October 15.
- Schulte PA, Kuempel E, Castranova V, Trout D [2008]. Assessing the toxicologic evidence base for medical surveillance of workers exposed to engineered nanoparticles (poster presentation). Second International Nanotechnology Conference—Nanotox 2008. Zurich, Switzerland, September 9.
- Schulte PA [2009]. Medical surveillance, exposure registries, and epidemiologic research. Presentation at the 4th International Conference on Nanotechnology—Occupational and Environmental Health. Helsinki, Finland, August 28.
- Schulte PA [2009]. Risk identification and evaluation of nanomaterials. Meeting on the nanotechnologies for members of the WHO Collaborating Center in Occupational Health. Helsinki, Finland, August 26.

- Schulte PA [2009]. Issues in epidemiological studies of workers exposed to engineered nanomaterials. 29th International Congress on Occupational Health. Capetown, South Africa, March 23.
- Schulte PA [2009]. Nanoparticles: challenges and solutions. 29th International Congress on Occupational Health. Capetown, South Africa, March 22–27.
- Geraci CL [2009]. Nanotechnology: is your (process) safety management system ready? Executive Conference Workshop on Handling Potent Pharmaceutical Compounds, Philadelphia, Pennsylvania, January 15.
- Geraci CL [2009]. Reapplication of potent compound handling containment practices to engineered nanoparticles. Executive Conference Workshop on Handling Potent Pharmaceutical Compounds, Philadelphia, Pennsylvania, January 15.
- Geraci CL [2009]. Good current practices for managing nanomaterials. 2nd Annual Massachusetts Nanotechnology Workshop, Massachusetts Department of Environmental Protection, Boston, Massachusetts, January 29.
- Geraci CL [2009]. Nanotechnology: the new workplace. Human health and exposure issues. NanoImpact Net Coordination Meeting, Lausanne, Switzerland, March 25.
- Geraci CL [2009]. Nanotechnology: the new workplace. NIOSH research to meet the challenge. Howard Hughes Medical Institute—Janelia Farm Research Campus, Environmental Health and Safety Conference, Loudon, Maryland, April 13–15.
- Geraci CL [2009]. Nanotechnology: the new workplace. NIOSH research to meet the challenge. INNO 09, IRSST Symposium, Montreal, Canada, April 24.
- Geraci CL [2009]. The role of NIOSH in responsible development of nanotechnology. NSTI Nanotech2009, Houston, Texas, May 4.
- Geraci CL [2009]. Working with nanomaterials: NIOSH research to meet the challenge. SOCMA-AIU Holdings, Inc., Webinar, April 21.
- Geraci CL [2009]. Evaluating exposure to engineered nanoparticles: progress in support of risk characterization. Toxicology and Risk Assessment Conference (TRAC), West Chester, Ohio, April 27.
- Geraci CL [2009]. An update of the NIOSH nanotechnology research program. American Industrial Hygiene Conference and Expo, Toronto, Canada, May 31.
- Geraci CL [2009]. The NIOSH Nanotechnology Research Program: update on carbon nanotube activity. California DTSC Carbon Nanotube Panel, San Francisco, California, June 22.
- Geraci CL [2009]. Nanotechnology: the new workplace. NIOSH research to meet the challenge. NPE International Plastics Expo, Chicago, Illinois, June 26.





- Geraci CL [2009]. An update of the NIOSH Nanotechnology Research Program. University of California, School of Public Health Nanoparticle Safety Symposium, Webinar, July 29.
- Geraci CL [2009]. Evaluating nanoparticle emissions in the workplace: a description of the approach used by NIOSH and a summary of findings from 12 site visits. 4th International Conference on Nanotechnology Occupational and Environmental Health, Helsinki, Finland, August 26.
- Geraci CL [2009]. Nanotechnology: the new workplace. Awareness to meet the challenge. Greater St. Louis Safety and Health Conference, St. Louis, MO, October 15.
- Geraci CL [2009]. Working with nanomaterials—addressing HS&E concerns in the workplace through successful collaborations. California DTSC Nanotechnology Initiative Symposium V: An Industry Perspective, Sacramento, California, November 16.
- Geraci CL [2009]. Nanomaterial exposure measurements: challenges and experiences. NNI Workshop: Nanomaterials and Human Health & Instrumentation, Metrology, and Analytical Methods, Washington, DC, November 18.
- Geraci CL [2009]. Nanotechnology: the new workplace. Meeting the challenge. 2nd USAF ASC/AFRL ESOH Nanomaterials Workshop, Dayton, Ohio, November 3.
- Hodson LL [2009]. Demonstration of the NIOSH nanoparticle emission assessment technique and facilitator of a breakout session on paint with silver nanoparticles. The Safe Development of Nanotechnology in Massachusetts. Boston, Massachusetts, January 29.
- Hodson LL [2009]. Nanotechnology—potential exposures and emission monitoring of engineered nanoparticles. 48th Annual Navy and Marine Corps Public Health Conference, Hampton, Virginia, March 25.
- Hodson LL [2009]. NIOSH nanotechnology research program and the nanoparticle emission assessment technique. University of SW Texas ERC, Health and Safety Conference on Nanotechnology. Austin, Texas, April 26.
- Hodson LL [2009]. Evaluating nanoparticle emissions in the workplace: a description of the approach used by NIOSH and a summary of findings from 12 site visits. Nanotech 2009, Houston, Texas, May 4.
- Crawford C, Hodson LL [2009]. Guidance for preparing good material safety data sheets (MSDSs) for engineered nanomaterials. Poster presentation at AIHce 2009, Toronto, Canada, June 1–4.
- Hodson LL [2009]. Update of the NIOSH nanotechnology field research team. AIHce 2009, Toronto, Canada, June 3.
- Hodson LL [2009]. Nanotechnology: a “tiny” primer on future and current issues. FL Workers Compensation Educational Conference, Orlando, FL August 17.



- Geraci CL, Hodson LL [2009]. Nanotechnology: demonstration of the emission assessment technique. Greater St. Louis Safety and Health Conference, St. Louis, MO, October 15.
- Hodson LL [2009]. Nanotechnology: role today and EHS implications. California Industrial Hygiene Council Conference, San Francisco, California, December 16.
- Schulte PA [2010]. NIOSH nanotechnology research program. Committee to Develop a Research Strategy for Environmental Health Aspects of Engineered Nanoparticles, National Academy of Science. Washington, DC, February 3.
- Geraci CL [2010]. Nanotechnology: risk management challenges. Yuma Pacific—Southwest Section, AIHA, Annual Meeting, Irvine, California, January 15.
- Geraci CL [2010]. The U.S. NIOSH nanotechnology research program. Keynote address to a special workshop of science and labor ministries in Japan, Tokyo, Japan, January 27–29.
- Geraci CL [2010]. The NIOSH nanotechnology research program: meeting the challenge for a safer workplace. Keynote address at a special symposium on worker education at the 2010 International Conference on Nanoscience and Nanotechnology, Sydney, Australia, February 23–25.
- Geraci CL [2010]. Nanotechnology: an opportunity to shape good policy by effectively converting research to practice. Keynote address at the 2nd Coordinating Meeting of NanoImpactNet, Lausanne, Switzerland, March 12.
- Geraci CL [2010]. Nanotechnology: collaboration opportunities for workplace safety. NanoBusiness Alliance Annual Policy Meeting, Washington, DC, March 16.
- Geraci CL [2010]. Risk management & the workplace. NNI Capstone Workshop: Risk Management Methods & Ethical, Legal, and Societal Implications of Nanotechnology, Washington, DC, March 30–31.
- Geraci CL [2010]. Update: NIOSH nanotechnology activities: what's new, and will it impact your research labs? Howard Hughes Medical Institute—Environmental Health and Safety Conference, Janelia Farm Research Campus, Ashburn, Virginia, April 7.
- Geraci CL [2010]. Working with nanomaterials: NIOSH research to meet the challenge. Chubb Insurance Company Loss Control Cornerstone Webinar, April 8.
- Geraci CL [2010]. Progress review: NTRC coordination. Scientific Symposium and NIOSH NTRC 2010 Update, Wheeling, West Virginia, April 20–21.
- Geraci CL [2010]. NIOSH nanotechnology activities: what's new, and will it apply to your research labs? Webinar for NASA Goddard Space Flight Center, Safety Campaign, April 26.



- Geraci CL [2010]. Prevention through design, nanotechnology, and green chemistry: facilitating a green economy. Green Chemistry Council, Houston, Texas, April 28.
- Geraci CL [2010]. Making green jobs safe: using prevention through design and green chemistry in nanotechnology. Good Jobs, Green Jobs Conference, Washington, DC, May 5.
- Geraci CL [2010]. Exposure to nanomaterials: challenges and lessons from the workplace. Toward Regulation of Nanomaterials. University of Notre Dame, May 10–12.
- Geraci CL [2010]. Overview of nanotechnology: NIOSH research to meet the challenge. Webinar presented to the Florida Office of the Judges of Compensation Claims, May 14.
- Geraci CL [2010]. Ask the experts: an update on NIOSH nanotechnology research. American Industrial Hygiene Conference, Denver, Colorado, May 25–27.
- Geraci CL [2010]. An overview of key health, safety and environmental issues. NanoTech 2011, Anaheim, California, June 21.
- Geraci CL [2010]. Exposure assessment: current exposure data. Nanomaterials and Worker Health: Medical Surveillance, Exposure Registries, and Epidemiologic Research, Key Stone, Colorado, July 21–22.
- Geraci CL [2010]. Responsible development of nanotechnology: NIOSH research to meet the challenge. Destination Nano Scientific Symposium, UMass-Lowell, Lowell, Massachusetts, September 22.
- Geraci CL [2010]. Nanotechnology: an opportunity for partnership, good science and good policy. Nanotechnology and Society: Emerging Organizations, Oversight, and Public Policy Systems, UMass-Amherst, Amherst, Massachusetts, September 24.
- Geraci CL [2010]. The NIOSH nanotechnology program: strategic research supporting responsible development. Smalley Institute Year of Nano, Occupational EH&S Symposium, Rice University, Houston, Texas, October 12.
- Geraci CL [2010]. Nanotechnology in the workplace: NIOSH research to meet the challenge. 2010 Technical Conference of the Association of Industrial Metalizers, Coaters and Laminators, Myrtle Beach, South Carolina, October 20.
- Geraci CL [2010]. Nanoinformatics and field investigations: customer and supplier. Nanoinformatics 2010, Arlington, Virginia, November 3–5.
- Geraci CL [2010]. Nanotechnology: challenges and opportunities for the industrial hygienist. Keynote address at the 2010 Northeast Regional Industrial Hygiene Conference and Exposition, Brunswick, NJ, December 3.

- Geraci CL [2010]. Nanotechnology: this century's biggest challenge. 20th Annual California Industrial Hygiene Council Conference, San Diego, California, December 6.
- Geraci CL [2010]. NIOSH nanotechnology research: promoting responsible development and partnerships. NNI Innovation Summit, Washington, DC, December 8–10.
- Schulte PA [2010]. Nanotechnologies and nanomaterials in the occupational setting. National Nanotechnology Initiative at Ten: Nanotechnology Innovation Summit, National Harbour, MD, December 8–10.
- Schulte PA [2010]. NIOSH nanotechnology efforts: progress report on protecting H & S of nanotech workers, Nanoinformatics 2010, Arlington, Virginia, November 3.
- Schulte PA [2010]. Nanotechnology Symposium VI: Progress in Protection, Department of Toxic Substance Control and California NanoSystems Institute. Los Angeles, California, October 13.
- Schulte PA [2010]. Nanotechnologies and nanomaterials in the workplace. Invited keynote presentation at the 8th International Scientific Conference, International Occupational Hygiene Association. Rome, Italy, September 29.
- Schulte PA [2010]. Occupational safety and health aspects of nanotechnology. Wisconsin Legislative Special Committee on Nanotechnology. Madison, WI, September 16.
- Schulte PA [2010]. Exposure Registries, Nanomaterials, and Worker Health Conference. Keystone, Colorado, July 22.
- Schulte PA [2010]. Overview of conference and issues. Opening presentation at the Conference on Nanomaterials and Worker Health: Medical Surveillance, Exposure Registries, and Epidemiologic Research. Keystone, Colorado, July 21.
- Schulte PA, Geraci CL [2010]. Protecting the health and safety of workers: a progress report. New England Nanomanufacturing Summit 2010. Lowell, Massachusetts, June 22.
- Schulte PA [2010]. Health surveillance of workers involved with nanomaterials. Invited presentation via SKYPE at the 1st Symposium on Impact of Nanotechnology in Workers Health and Safety and the Environment. Sao Paulo, Brazil, May 25.
- Schulte PA [2010]. Nanotechnology: the 3rd industrial revolution in preventing adverse health effects from nanotechnology. Public Health Grand Rounds: Centers for Disease Control and Prevention, Atlanta, Georgia, April 15.
- Schulte PA [2010]. NIOSH nanotechnology research program. Committee to Develop a Research Strategy for Environmental Health Aspects of Engineered Nanoparticles: National Academy of Science. Washington, DC, February 3.



- Hodson LL [2010]. Occupational health aspects of engineered nanomaterials: the NIOSH perspective. Northwestern University Town Hall Meeting, Evanston, Illinois, January 12.
- Hodson LL [2010]. Application of control banding to engineered nanomaterials. One section of an AIHA teleweb training class on hazard banding. February 25.
- Hodson LL [2010]. Risk management of nanomaterials. 2010 Indiana Safety and Health Conference, Indianapolis, Indiana, March 2.
- Hodson LL [2010]. Occupational health aspects of polymer nanocomposites. Polymer Nanocomposites 2010, Lehigh University, Bethlehem, Pennsylvania, March 8.
- Hodson LL, Methner MM, Geraci CL [2010]. Lessons learned from the field: how to protect yourself from occupational exposure to engineered nanomaterials. Nanotech 2010, Anaheim, California, June 24.
- Methner MM, Hodson LL, Geraci CL, Crawford C [2010]. Findings from the nanotechnology field research team: a photodocumentary. Poster at the Nanomaterials and Worker Health Conference, Keystone, Colorado, July 21–23.
- Hodson LL, Methner MM, Geraci CL, Crawford C [2010]. Findings from the nanotechnology field research team. Poster at the Nanomaterials and Worker Health Conference, Keystone, Colorado, July 21–23.
- Hodson LL [2010]. Imaging challenges. NanoImpact Net, Dublin, Ireland, September 9.
- Hodson LL [2010]. Advantages of the nanoparticle emission assessment technique and challenges of data interpretation. NanoImpact Net, Dublin, Ireland, September 9.
- Hodson LL [2010]. Engineering case control studies: nanomaterials. Professional Conference on Industrial Hygiene (PCIH), Fort Worth, Texas, October 12.
- Hodson LL [2010]. The NIOSH nanotechnology research program: meeting the challenge for a safer workplace. American Institute of Chemical Engineers (AIChE), Salt Lake City, Utah, November 9.
- Hodson LL [2010]. Minimizing potential exposure to nanomaterials in the workplace through process design. American Institute of Chemical Engineers (AIChE), Salt Lake City, Utah, November 9.
- Hodson LL [2010]. Exposure to nanomaterials: lessons learned from the workplace. American Institute of Chemical Engineers (AIChE), Salt Lake City, Utah, November 9.
- Hodson LL [2010]. Nanomaterial workplace sampling. Workshop on Nano Measurement Strategy and Database, TNO, Zeist, the Netherlands, December 16–17.

- Trout D [2010]. Medical surveillance and screening overview. NTRC 2010 Update, Wheeling, West Virginia, April 20.
- Trout D [2010]. Medical surveillance for workers potentially exposed to nanomaterials. Nanomaterials and Worker Health: Medical Surveillance, Exposure Registries, and Epidemiologic Research Conference, Keystone, Colorado, July 21.
- Schulte PA, Trout D, Hodson L [2011]. Critical issues in medical surveillance and epidemiologic investigation of workers exposed to nanomaterials. Presentation at the 5th International Symposium on Nanotechnology, Occupational, and Environmental Health, Boston, Massachusetts, August 11.
- Geraci CL [2011]. Workplace exposure to nanomaterials: current state of understanding. American Insurance Association Issues Briefing, Washington, DC, January 20.
- Schulte PA [2011]. Overview of the draft NIOSH current intelligence bulletin (CIB): occupational exposure to carbon nanotubes and nanofibers. Presentation to the Nanotechnology Environmental Health Implications Working Group Meeting, Washington, DC, January 20, 2011.
- Geraci CL [2011]. Overview of the NIOSH current intelligence bulletin: occupational exposure to carbon nanotubes/nanofibers. Public Meeting, Cincinnati, Ohio, February 3.
- Schulte PA [2011]. Proposal for the constitution of a new working group on occupational safety and health and exposure to nanomaterials. Mid-term Meeting of the International Commission on Occupational Health, Milan, Italy, February 3.
- Geraci CL [2011]. How relevant are model nanoparticles to understanding exposure in the workplace? How relevant are they to recommending industrial hygiene practices? US-EU Workshop on Bridging Nano EHS Research Efforts, National Nanotechnology Initiative, Washington, DC, March 10.
- Schulte PA [2011]. Critical issues in the identification and control of occupational hazards of nanomaterials. The NANODEVICE Annual Forum for Nanosafety workshop. Berlin, Germany, March 18.
- Geraci CL [2011]. Regulation and risk management of nanotechnology: the NIOSH perspective. Arizona State University Workshop: The Biggest Issues for the Smallest Stuff. Phoenix, Arizona, March 21.
- Geraci CL [2011]. Building a risk management program: where to start for nanomaterials. Annual Scientific Symposium, Pittsburgh Section AIHA, Pittsburgh, Pennsylvania, April 6.
- Geraci CL [2011]. NIEHS/NIOSH concept: nanomaterials exposure assessment. NIEHS/NTP Board of Scientific Counselors Meeting, Research Triangle Park, North Carolina, April 13.
- Geraci CL [2011]. Recent significant activities specific to carbon nanotubes and nanofibers. Ohio Innovation Summit, Toledo, Ohio, April 20.



- Geraci CL [2011]. The NIOSH nanotechnology strategic plan for research and guidance. Mercer—ORC EHS Law Network, Washington, DC, May 3.
- Geraci CL [2011]. Recent actions on specific nanomaterials: impact on risk management? University of Cincinnati Symposium on Nanotechnology, Cincinnati, Ohio, May 10.
- Geraci CL [2011]. An update of the NIOSH nanotechnology research program: ask the experts. American Industrial Hygiene Conference and Exposition, Portland, Oregon, May 17.
- Geraci CL [2011]. Nanomaterial exposure assessment: current knowledge and challenges. American Industrial Hygiene Conference and Exposition, Portland, Oregon, May 17.
- Geraci CL [2011]. Roundtable 234. Risk assessment applied to engineered nanomaterials: managing risk with limited data. American Industrial Hygiene Conference and Exposition, Portland, Oregon, May 17.
- Geraci CL [2011]. The NIOSH nanotechnology research program: responsible development and commercialization. 2011 TAPPI International Conference on Nanotechnology for Renewable Materials, Washington, DC, June 6.
- Geraci CL [2011]. Update to the NNI on NIOSH research activities. US NNI Nanotechnology Environmental and Health Implications Workgroup, Washington, DC, June 25.
- Geraci CL, Schulte PA, Zumwalde R, Kuempel E, Castranova V [2011]. The NIOSH current intelligence bulletin for carbon nanotubes and nanofibers. 5th International Symposium on Nanotechnology Occupational and Environmental Health, Boston, Massachusetts, August 10–12.
- Geraci CL [2011]. The U.S. National Nanotechnology Initiative: safety and health research & development coordination and strategy development. 5th International Symposium on Nanotechnology Occupational and Environmental Health, Boston, Massachusetts, August 10–12.
- Geraci CL [2011]. Nanotechnology: opportunities and challenges in manufacturing. National Occupational Research Agenda: Manufacturing Sector Symposium, Cincinnati, Ohio, September 7.
- Geraci CL [2011]. The NIOSH approach to supporting nanomaterial commercialization. Nanomanufacturing Summit 2011 & 10th Annual NanoBusiness Conference, Boston, Massachusetts, September 26.
- Geraci CL [2011]. Nanotechnology: preparing for new workplace challenges—hazards, risks and regulations. National Safety Council Webinar, September 27.
- Geraci CL [2011]. Meeting the challenge of sustainable use of nanomaterials in construction. American Concrete Institute, Fall Technical Conference, Cincinnati, Ohio, October 17.



- Geraci CL [2011]. Nanotechnology research at NIOSH: ensuring responsible nanomaterial development and commercialization. Nanotechnology for Defense Conference, Department of Defense, Seattle, WA, October 27.
- Geraci CL [2011]. Nanomaterials: applying risk assessment/management approaches in the face of uncertainty. Professional Conference on Industrial Hygiene, Risk Assessment Symposium, Baltimore, Maryland, November 3.
- Geraci CL, Schulte PA [2011]. ETIPC update: key NIOSH activities. Emerging Technologies Interagency Policy Committee, US Office of Science and Technology Policy, Washington, DC, November 7.
- Geraci CL [2011]. The NIOSH nanotechnology research program: promoting best practices in research and development. University of Alberta, Science Symposium, Edmonton, Alberta, Canada, November 16.
- Geraci CL [2011]. Research to practice to policy: the information needs for safe and responsible development of nanotechnology. NSF Workshop on Nanotechnology Infrastructure Safety, University of Central Florida, Orlando, Florida, December 9.
- Hodson L, Geraci C, Crawford C [2011]. A critical evaluation of past and present safety data sheets for engineered nanomaterials. AIHce 2011, Portland, Oregon, June 6–9.
- Hodson L [2011]. Use of model nanoparticles to understand exposures in the workplace. Bridging US-EU Nano EHS Research Efforts, Washington, DC, March 11.
- Hodson L, Geraci C [2011]. Significant NIOSH activities specific to carbon nanotubes and nanofibers. Presented at Nanotech 2011, Boston, Massachusetts, June 16.
- Berges M, Brouwer D, Fransman W, Bello D, Hodson L, et al. [2011]. Towards a harmonized assessment of the exposure to manufactured nano objects: common approaches in measurement strategy and obstacles. Report of a workshop. NanoImpactNet Meeting, Nancy, France, April 5–7.
- Hodson L, Schulte P, Geraci C [2011]. The NIOSH Nanotechnology Research Center strategic plan for FY 13–15. 5th International Symposium on Nanotechnology–Occupational and Environmental Health, Boston, Massachusetts, August 10–12.
- Schulte P, Kuempel E, Zumwalde R, Geraci C, Schubauer-Berigan M, Castranova V, Hodson L, Murashov V, Ellenbecker M [2011]. Focused actions to protect carbon nanotube workers. 5th International Symposium on Nanotechnology–Occupational and Environmental Health, Boston, Massachusetts, August 10–12.
- Schulte P, Trout D, Hodson L [2011]. Critical issues in medical surveillance and epidemiologic investigation of workers exposed to nanomaterials. 5th International Symposium on Nanotechnology–Occupational and Environmental Health, Boston, Massachusetts, August 10–12.





- Schulte P, Kuempel E, Castranova V, Geraci C, Hoover M, Stefaniak A, Hodson L, Zumwalde R, Murashov V [2011]. Issues in establishing categorical occupational exposure limits for nanomaterials. 5th International Symposium on Nanotechnology Occupational and Environmental Health. Boston, Massachusetts, August 10–12.
- Beaucham C, Geraci C, Hodson L, Tsai S, Ellenbecker M [2011]. Safe practices for working with engineered nanomaterials in research laboratories. Poster presentation, PS 404-6. American Industrial Hygiene Conference and Exposition, Portland, Oregon, May 16–19.
- McKernan J, Geraci C, Ellenbecker M, Dunn K, Tsai S [2011]. Engineering control recommendations for nanomaterials. Poster presentation, PS 404-8. American Industrial Hygiene Conference and Exposition. Portland, Oregon, May 16–19.
- Beaucham C, Dahm M, Evans D, Geraci C, Hodson L [2011]. Refining the nanoparticle emission assessment technique. Poster presentation, PA-02. 5th International Symposium on Nanotechnology Occupational and Environmental Health, Boston, Massachusetts, August 10–12.
- Ramachandran G, D'Arcy J, O'Shaughnessy P, Geraci C, Ostraat M, Evans D, Methner M, Stevenson E, Maynard A, Rickabaugh K [2011]. A research-to-practice approach to promote nanotechnology health and safety. Poster presentation, PA-03. 5th International Symposium on Nanotechnology Occupational and Environmental Health, Boston, Massachusetts, Aug 10–12.
- Kuempel E, Geraci C, Castranova V, Schulte P [2011]. Development of risk-based nanoparticle groups for occupational exposure control. 5th International Symposium on Nanotechnology Occupational and Environmental Health, Boston, Massachusetts, August 10–12.
- Ostraat M, Ramachandran G, D'Arcy J, O'Shaughnessy P, Geraci C, Olson G, Evans D, Methner M, Stevenson E, Maynard A, Rickabaugh K [2011]. An expert working group to promote nanotechnology health and safety. 5th International Symposium on Nanotechnology Occupational and Environmental Health, Boston, Massachusetts, August 10–12.

### NIOSH Nanotechnology Exhibits

- International Conference on Nanotechnology, Occupational and Environmental Health and Safety: Research to Practice, Cincinnati, Ohio, December 4–7, 2006
- Ohio Innovation Summit, Mason, Ohio, April 15–16, 2008
- Ohio Innovation Summit, Dayton, Ohio, April 20–22, 2009
- Nanotech 2009, Houston, Texas, May 4–7, 2009
- AIHce 2009, June 1–3, 2009

- National Plastics Exhibition (NPE 2009), June 22–24, 2009
- Florida’s Workers Compensation Educational Conference, August 17–18, 2009
- Greater St. Louis Safety and Health Conference, St. Louis, Missouri, October 15, 2009
- RIMS 2010, Boston, Massachusetts, April 21–23, 2010
- Nanotech 2010, Anaheim, California, June 22–24, 2010
- NNI at 10, National Harbor, Maryland, December 8–9, 2010
- Ohio Innovation Summit, Toledo, Ohio, April 18–20, 2011
- Nanotech 2011, Boston, Massachusetts, June 13–16, 2011
- 5th International Symposium on Nanotechnology–Occupational and Environmental Health, Boston, Massachusetts, August 19–21, 2011



## **Project 2: Nanotechnology Safety and Health Research Coordination (Nanotoxicology)**

**Principal Investigator:** Vincent Castranova, PhD

**Project Duration:** FY 2004–2008

**Critical Topic Area:** Toxicology and internal dose

### **Accomplishments and Research Findings**

- Coordinated the NIOSH nanotoxicology program.
- Fostered collaboration among investigators in the nanotoxicology program.
- Fostered collaboration in nanotechnology research with
  - Consumer Products Safety Commission
  - International Alliance for NanoEHS Harmonization
  - Mitsui & Co.
  - West Virginia University
  - NASA
  - University of Rochester
  - University of Montana
  - University of Pittsburgh
  - Karolinska Institute
- Represented NIOSH during involvement with several national and international working groups on nanotechnology safety and health.
- Represented NIOSH during involvement with the National Nanotechnology Initiative nanotechnology environmental and health implication strategic planning group.
- Presented overviews of the NIOSH nanotoxicology program to numerous organizations.

### **Publications and Abstracts**

- Mossman BT, Borm PJ, Castranova V, Costa DL, Donaldson K, Kleeberger SR [2007]. Mechanisms of action of inhaled fibers, particles, and nanoparticles in lung and cardiovascular diseases. Part Fibre Toxicol 4:4.

- Leonard SS, Castranova V, Chen BT, Schwegler-Berry D, Hoover M, Piacitelli C, Gaughan D [2007]. Particle size dependent generation from wildland fire smoke. *Toxicology* 236:103–113.
- Balbus JM, Maynard AD, Colvin VL, Castranova V, Daston GP, Denison RA, Dreher KL, Goering PL, Goldberg AM, Kulinowski KM, Monteiro-Riviere NA, Oberdörster G, Omenn GS, Pinkerton KE, Ramos KS, Rest KM, Sass JB, Silbergeld EK, Wong BA [2007]. Meeting report: hazard assessment for nanoparticles. *Environ Health Perspect* 115(11):1654–1659.
- Schulte PA, Trout D, Zumwalde R, Kuempel E, Geraci CL, Castranova V, Mundt DJ, Mundt K, Halperin WE [2008]. Options for occupational health surveillance of workers potentially exposed to engineered nanoparticles: state of the science. *J Occup Environ Med* 50:517–526.
- Papp T, Schiffmann D, Weiss D, Castranova V, Vallyathan V, Rahman Q [2008]. Human health implications of nanomaterial exposure. *Nanotoxicol* 2:9–27.
- Ayres JG, Borm P, Cassee F, Castranova V, Donaldson K, Ghio A, Harrison RM, Hider R, Kelly F, Kooter I, Marano F, Maynard RL, Mudway I, Nel A, Sioutas C, Smith S, Baeza-Squiban A, Cho A, Duggan S, Froines J [2008]. Evaluating the toxicity of airborne particulate matter and nanoparticles by measuring oxidative stress potential—a workshop report and consensus statement. *Inhal Toxicol* 20:75–99.
- Castranova V [2008]. The nanotoxicology research program in NIOSH. *J Nanopart Res* [[www.springerlink.com/content/c302m62567162101/](http://www.springerlink.com/content/c302m62567162101/)].
- Pacurari M, Yin XJ, Zhao J, Ding M, Leonard SS, Schwegler-Berry D, Ducatman BS, Sbarra D, Hoover MD, Castranova V, Vallyathan V [2008]. Raw single-walled carbon nanotubes induce oxidative stress and active MAPKs, AP-1, NFκB, and Akt in normal and malignant human mesothelial cells. *Environ Health Perspect* 116:1211–1217.
- Pacurari M, Yin XJ, Ding M, Leonard SS, Schwegler-Berry D, Ducatman BS, Chirila M, Endo M, Castranova V, Vallyathan V [2008]. Oxidative and molecular interactions of multi-walled carbon nanotubes in normal and malignant human mesothelial cells. *Nanotoxicol* 2:115–170.
- Vallyathan V, Pacurari M, Yin X, Zhao J, Ding M, Leonard S, Ducatman B, Castranova V [2008]. Alterations in molecular signaling of human mesothelial cells exposed to raw single-walled carbon nanotubes. *Respir Crit Care Med* 177(Abs Issue):A219.
- Pacurari M, Robinson V, Castranova V, Leonard SS, Chen F, Vallyathan V, Bargern M [2008]. Does sandblasted metal attenuate or enhance the toxicity of freshly fractured silica? *Toxicologist* 102:A300.
- Castranova V [2008]. Comparison of in vitro, pharyngeal aspiration, and inhalation results for single-walled carbon nanotubes. *Toxicologist* 102:A2356.



- Hubbs AF, Mercer RR, Sriram K, Castranova V, Chen BT, McKinney W, Frazer DG, Batelli L, Willard P, Scabilloni J, Schwegler-Berry D, Porter D [2008]. Acute respiratory toxicologic pathway of inhaled multi-walled carbon nanotubes. *Vet Pathol* 45:A 220.
- Schulte PA, Geraci CL, Zumwalde R, Hoover M, Castranova V, Kuempel E, Murashov V, Vainio H, Savolainen K [2008]. Sharpening the focus on occupational safety and health of nanotechnology. *Scand J Work Environ Health* 34:471–478.

### Invited Presentations

- Castranova V [2007]. Nanotoxicology research in NIOSH. Toxicology forum, Washington, DC, January 30.
- Castranova V [2007]. Nanotechnology research in NIOSH. Meeting of the Northeastern chapter of the American Industrial Hygiene Association, Cleveland, Ohio, May 8.
- Castranova V [2007]. Nanotoxicology research in NIOSH. NASA Glenn Research Center, Cleveland, Ohio, May 8.
- Castranova V [2007]. Nanotoxicology research in NIOSH. American Industrial Hygiene Association conference and exposition, Philadelphia, Pennsylvania, June 2–7.
- Castranova V [2007]. Nanotoxicology research in NIOSH. West Virginia University Cancer Center, NTRC meeting in Morgantown, West Virginia, February 21.
- Castranova V [2007]. Critical toxicity parameters for nanoparticles vs. conventional particles. Presentation for the Department of Occupational Medicine, West Virginia University, Morgantown West Virginia, August 28.
- Castranova V [2007]. Critical toxicity parameters for nanoparticles vs. conventional particles. Department of Physiology, West Virginia University, Morgantown, West Virginia, August 30.
- Castranova V [2007]. What do we know about exposure and human health effects on nanoparticles? Annual Scientific Conference of the Occupational and Environmental Medical Association of Canada, Banff, Alberta, Canada, October 15 and 16.
- Castranova V [2007]. Critical toxicology parameters for nanoparticles vs. conventional particles. Conference on Bringing toxicology to global issues in occupational and environmental public health. Louisville, Kentucky, October 18.
- Castranova V [2007]. Biological effects of nanoparticles. State-of-the-Art Conference/ International Conference on Health Care Worker Health, Vancouver, Canada, October 26–28.

- Castranova V [2007]. NIOSH nanomaterials research activities. International Life Sciences Institute (ILSI) Nanomaterials Environmental Health And Safety Project Committee, Washington, DC, November 8.
- Castranova V [2007]. Critical toxicity parameters for nanoparticles vs. conventional particles. Nanotechnology and occupational health and safety conference, Santa Barbara, California, November 16 and 17.
- Castranova V [2007]. NIOSH nanotoxicology research. European NanOSH conference—Nanotechnologies: A Critical Area in Occupational Safety and Health, Helsinki, Finland, December 3–5.
- Castranova V [2008]. The nanotoxicology research program in NIOSH. National Institute of Standards and Technology, Gaithersburg, Maryland, January 28.
- Castranova V [2008]. Nanotoxicology research in NIOSH: nanotechnology update for industrial hygienists. American Industrial Hygiene Association Distance Learning Program, January 31.
- Castranova V [2008]. Critical toxicity parameters for nanoparticles vs. conventional particles. Northern California Industrial Hygiene Society meeting, Palo Alto, California, May 14.
- Castranova V [2008]. NIOSH nanotoxicology program. American Industrial Hygiene Association Conference and Exposition, Minneapolis, Minnesota, May 31–June 5.
- Castranova V [2008]. NIOSH nanotoxicology research: biological activity of single-walled carbon nanotubes. American Industrial Hygiene Association Conference and Exposition, Minneapolis, Minnesota, May 31–June 5.



## Project 3: Development of New Research in Occupational Health (Nanotoxicology)

**Principal Investigator:** Vincent Castranova, PhD

**Project Duration:** FY 2009–2015

**Critical Topic Area:** Toxicology and internal dose

### Accomplishments and Research Findings

- Evaluated the role of various physicochemical properties of nanoparticles, such as generation of oxidants and particle surface area, on their bioactivity.
- Determined that improved dispersion enhances the bioactivity of nanoparticles.
- Determined that the pulmonary toxicity and systemic translocation of ZnO nanoparticles is determined by their dissolution rate.
- Determined that asbestos and CNT affect similar molecular signaling pathways in cultured lung cells, with asbestos exhibiting greater potency.
- Determined the effects of TiO<sub>2</sub> nanoparticles on pulmonary inflammation and neuroimmune responses in developing airways.
- Determined that in vitro exposure of endothelial cells alters the cytoskeleton, making tight junctions leaky.

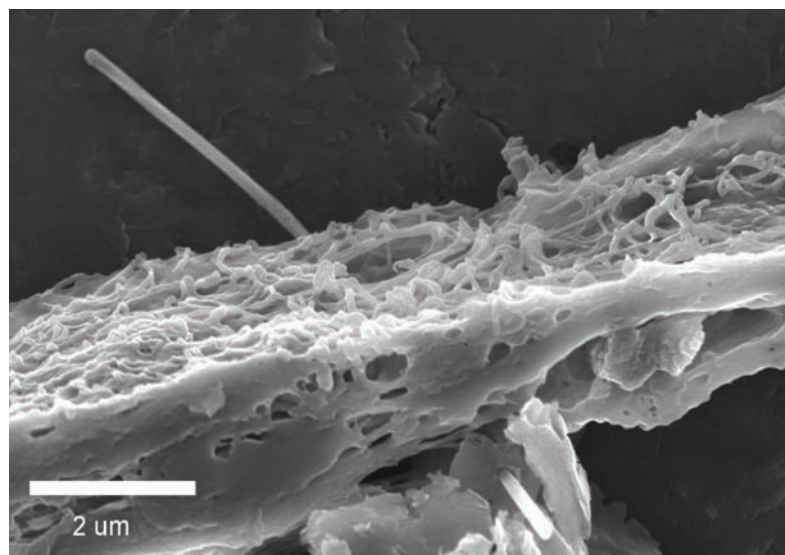

Penetration of visceral pleura by multi-walled carbon nanotube



## Publications and Abstracts

- Nel A, Madler L, Velegol D, Xia T, Hoek E, Somasundaran S, Klaessig F, Castranova V, Thompson M [2009]. Understanding bio-physicochemical interactions at the nano-bio interface. *Nature Nanomaterials* 8:543–557.
- Apopa PL, Qian Y, Guo NL, Schwegler-Berry D, Pacurari M, Porter D, Shi X, Vallyathan V, Castranova V, Flynn DC [2009]. Iron nanoparticles induce human microvascular endothelial cell permeability through reactive oxygen species production and microtubule remodeling. *Particle Fibre Toxicol* 6:1.
- Sager TM, Castranova V [2009]. Surface area of particle administered versus mass in determining the pulmonary toxicity of ultrafine and fine carbon black: comparison to ultrafine titanium dioxide. *Particle Fibre Toxicol* 6:15.
- Borm P, Castranova V [2009]. Toxicology of nanomaterials: permanent interactive learning. *Particle Fibre Toxicol* 6:28.
- Donaldson K, Borm PJA, Castranova V, Gulumian M [2009]. The limits of testing particle-mediated oxidative stress in vitro in predicting diverse pathologies; relevance for testing of nanoparticles. *Particle Fibre Toxicol* 6:13.
- Moon C, Park H-J, Choi Y-H, Park E-M, Castranova V, Kang J-HL [2010]. Pulmonary inflammation after intra peritoneal administration of ultrafine titanium dioxide (TiO<sub>2</sub>) at rest or in lungs primed with lipopolysaccharide. *J Toxicol Environ Health Part A* 73:396–409.
- Pacurari M, Castranova V, Vallyathan V [2010]. Single- and multi-walled carbon nanotubes vs asbestos: are the carbon nanotubes a new health risk to humans? *J Toxicol Environ Health Part A* 73:378–395.
- Geraci CL, Castranova V [2010]. Challenges in assessing nanoparticle toxicology: a personal perspective. *Wiley Interdisciplinary Reviews: Nanomedicine and Nanobiotechnology*, doi:10.1002/wnan.108.
- Rushton EK, Jiang J, Leonard SS, Eberly S, Castranova V, Biswas P, Elder A, Han X, Gelein R, Finkelstein J, Oberdorster G [2010]. Concepts of assessing nanoparticle hazards considering nanoparticle dose-metric and chemical/biological response-metrics. *J Toxicol Environ Health Part A* 73:445–461.
- Sager TM, Molina R, Donaghey T, Brian J, Castranova V [2010]. Effects of particle size and route of exposure on the bioavailability of zinc from nano-sized zinc oxide particles. *Toxicologist* 114:1, A278.
- Scuri M, Chen BT, Castranova V, Reynolds JS, Johnson VJ, Samsell L, Walton C, Piedimonte G [2010]. Effects of titanium dioxide nanoparticle exposure on neuroimmune responses in rat airways. *J Toxicol Environ Health Part A* 73:1353–1369.
- Castranova V [2011]. Factors governing pulmonary response to inhaled particulate matter. In: Kulkarni P, Baron PA, Willeke K, eds. *Aerosol measurement: principles, techniques, and applications*. 3rd ed. New York: John Wiley & Sons, Inc., pp. 793–803.



- Xia T, Zhao Y, Sager T, George S, Pokhrel S, Li N, Schoenfield D, Meng H, Lin S, Wang X, Wang M, Ji Z, Zink JL, Madler L, Castranova V, Lin S, Nel AE [2011]. Decreased dissolution of ZnO by iron doping yields nanoparticles with reduced toxicity in the rodent lung and zebrafish embryos. *ACS Nano* 5:1223–1235.
- Hubbs AF, Mercer RR, Benkovic SA, Harkema J, Sriram K, Schwegler-Berry D, Goravanahally MP, Nurkiewicz TR, Castranova V, Sargent LM [2011]. Nanotoxicology: a pathologist's perspective. *Toxicol Pathol* 39(2):301–324.
- Kuempel E, Castranova V [2011]. Hazard and risk assessment of workplace exposure to engineered nanoparticles: Methods, issues, and carbon nanotubes case study. In: Ramachandran G, ed. *Assessing nanoparticle risks to human health*. New York: Elsevier, pp. 65–97.
- Schulte PA, Geraci CL, Zumwalde R, Castranova V, Kuempel E, Methner MM, Hoover M, Murashov V [2010]. Nanotechnologies and nanomaterials in the occupational setting. *Ital J Occup Environ Hyg* 1(2) 63–68.
- Knuckles TL, Yi L, Frazer D, Cumpston J, Chen B, Castranova V, Nurkiewicz TR [2011]. Nanoparticles alter cyclooxygenase activity in microvascular dysfunction. *Toxicologist* 120:316, A1471.
- Stapleton PG, Minarchick VC, Cumpston A, McKinney W, Chen BT, Frazer D, Castranova V, Nurkiewicz TR [2011]. Time-course of impaired coronary arteriolar endothelium-dependent dilation after multi-walled carbon nanotube inhalation. *Toxicologist* 120:41, A194.
- Zhao J, Castranova V [2011]. Toxicology of nanomaterials used in nanomedicine. *J Toxicol Environ Health Part B* 14:593–632.
- Pacurari M, Schwegler-Berry D, Friend S, Leonard SS, Mercer RR, Vallyathan V, Castranova V [2011]. Raw single wall carbon nanotube-induced cytotoxic effects in human bronchial epithelial cells: comparison to asbestos. *Toxicol Environ Chem* 93:1045–1072.
- Pacurari M, Qian Y, Porter DW, Wolfarth M, Wan Y, Luo D, Ding M, Castranova V, Guo NL [2011]. Multi-walled carbon nanotube-induced gene expression in the mouse lung: association with lung pathology. *Toxicol Appl Pharmacol* 255:18–31.

### Invited Presentations

- Castranova V [2009]. Comparison of in vitro, pharyngeal aspiration and inhalation results for single-walled carbon nanotubes. American Industrial Hygiene Association Distance Learning Program, Toxicology of Engineered and Incidental Nanoparticles. Jan. 27.
- Castranova V [2009]. The nanotoxicology research program in NIOSH. Nanotoxicology Specialty Section, SOT, Baltimore, Maryland, March 22.

- Castranova V [2009]. The nanotoxicology research program in NIOSH. EPA, Washington, DC, May 27.
- Castranova V [2009]. Critical toxicity parameters for nanoparticles vs. conventional particles. Ceramics Meeting, Cleveland, Ohio, May 21.
- Castranova V [2009]. Elongated nanoparticles—how they resemble and differ from asbestos. Interagency Asbestos Working Group, Atlanta, Georgia, April 22.
- Castranova V [2009]. Elongated nanoparticles—how they resemble and differ from asbestos. Nanofiber 2009, Tokyo, Japan, June 19.
- Castranova V [2009]. Pulmonary response to MWCNT exposure. Nanofiber Extended Workshop, Nagano, Japan, June 22.
- Castranova V [2009]. NIOSH nanotoxicology research: biological activity of single-walled carbon nanotubes. toxicology forum, Aspen, Colorado, July 16.
- Castranova V [2009]. Potential pulmonary effects of single-walled carbon nanotube (SWCNT) exposure: in vitro genotoxic effects. 10th International Conference on Environmental Mutagens, Florence, Italy, Aug. 20.
- Castranova V [2009]. Pulmonary response to pharyngeal aspiration of multi-walled carbon nanotubes in mice. 4th International Conference on Nanotechnology: Occupational and Environmental Health, Helsinki, Finland, Aug. 28.
- Castranova V [2009]. Possible health implications of nanotechnology. Catholic Academy of Science in the United States, Sept. 26.
- Chen BT, McKinney WD, Schwegler-Berry, Castranova V, Frazer DG [2009]. Aerosolization and characterization of multi-walled carbon nanotubes for inhalation studies. AAAR 28th Annual Conference, October 26–30.
- Castranova V [2009]. Pulmonary responses to MWCNT exposure. Department of Environmental and Occupational Health, University of Pittsburgh, Pennsylvania, Nov. 22.
- Castranova V [2010]. Pulmonary responses to MWCNT exposure. UCLA, Los Angeles, California, Feb. 9.
- Castranova V [2010]. Developing risk characterization information to determine and classify nanomaterials based on physical and chemical properties. NNI Capstone Workshop, Arlington, Virginia, March 30.
- Castranova V [2010]. Hazard assessment of nanomaterials: why is it so challenging? CDC Public Health Grand Rounds, Atlanta, Georgia, April 15.
- Castranova V [2010]. Pulmonary response to pharyngeal aspiration of multi-walled carbon nanotubes in mice. American Association for Cancer Research Conference, Washington, DC, April 17.
- Castranova V [2010]. Risk assessment strategy for nanoparticles: multi-walled carbon nanotubes as a test case. Conference on workplace aerosols. Karlsruhe, Germany, July 2.



- Castranova V [2010]. Pulmonary response to pharyngeal aspiration of multi-walled carbon nanotubes in mice. NIST, Boulder, Colorado, July 20.
- Castranova V [2010]. Overview of current toxicological knowledge of engineered nanoparticles, nanomaterials and worker health: Medical Surveillance, Exposure Registries, and Epidemiologic Research Conference, Keystone, Colorado, July 21.
- Castranova V [2010]. Risk assessment strategy for nanoparticles: multi-walled carbon nanotubes as a test case, ORC WORLDWIDE Occupational Safety and Health Group and Corporate Health Directors Network Meeting, Washington, DC, August 4.
- Castranova V [2010]. Overview of current toxicological knowledge of engineered nanoparticles, 5th International Conference on the Environmental Effects of Nanoparticles and Nanomaterials: 2010, Clemson, South Carolina, August 23.
- Castranova V [2010]. Elongated nanoparticles: how they resemble and differ from asbestos. Columbia University, New York, New York, November 4.
- Castranova V [2010]. Pulmonary response to pharyngeal aspiration of multi-walled carbon nanotubes in mice. SUNY-Stony Brook, Stony Brook, New York, November 9.
- Castranova V [2011]. Pulmonary and systemic responses to carbon nanotubes. SOT Meeting, Washington, DC, March 9.
- Castranova V [2011]. The effect of agglomerate structure size on the bioactivity of nanoparticles. SOT Meeting, Washington, DC, March 9.
- Castranova V [2011]. Nanotechnology research in NIOSH. US-EU Nanotoxicology Workshop, Washington, DC, March 10.
- Castranova V [2011]. Risk assessment and development of a recommended exposure limit for carbon nanotubes by NIOSH. Harvard School of Public Health, Boston, Massachusetts, April 7.
- Castranova V [2011]. Overview of current toxicological knowledge of engineered nanoparticles. NPPTL/NIOSH, Bruceton, Pennsylvania, April 21.
- Castranova V [2011]. Responses of pulmonary exposure to nanoparticles. nanoparticles: tools for toxicology, The Toxicology Forum and the Regulatory Governance Initiative, Ottawa, Canada, May 2.
- Castranova V [2011]. Risk assessment and development of a recommended exposure limit for carbon nanotubes by NIOSH. Health Canada, Ottawa, Canada, May 2.
- Castranova V [2011]. Responses to pulmonary exposure to nanoparticles in NIOSH animal studies. Medichem: Occupational Health in a Changing World, Heidelberg, Germany, June 4.

- Castranova V [2011]. Cardiovascular effects of pulmonary exposure to nano or fine particles. 7th International Symposium on Modern Principles of Air Monitoring and Biomonitoring, Loen, Norway, June 20.
- Castranova V [2011]. Overview of current toxicological knowledge of engineered nanoparticles. 5th International Symposium on Nanotechnology, Occupational and Environmental Health. Boston, Massachusetts, August 9.
- Castranova V [2011]. Potential pulmonary effects of single-walled carbon nanotube (SWCNT) exposure: in vitro genotoxic effects. 5th International Symposium on Nanotechnology, Occupational and Environmental Health. Boston, Massachusetts, August 10.
- Castranova V [2011]. Responses to pulmonary exposure to nanoparticles in niosh animal studies. ESF Symposium: Nanocarbons 2011. Acquafredda di Maratea, Italy, September 6–11.



## Project 4: Systemic Microvascular Dysfunction: Effects of Ultrafine vs. Fine Particles

**Principal Investigator:** Vincent Castranova, PhD

**Project Duration:** FY 2006–2010

**Critical Topic Area:** Toxicology and internal dose

### Accomplishments and Research Findings

- Determined that pulmonary exposure to nano TiO<sub>2</sub> inhibits the responsiveness of coronary arterioles to dilators.
- Evaluated mechanisms by which generation of reactive species inhibits the ability of systemic and coronary microvessels to respond normally to dilators after inhalation of nano TiO<sub>2</sub>.
- Evaluating neurogenic mechanisms by which inhalation of nano TiO<sub>2</sub> alters the normal response of systemic microvessels to dilators and sympathetic constriction.
- Evaluating the effect of inhalation of MWCNT on the ability of coronary arterioles to respond normally to dilatory inputs.
- Evaluating the cardiovascular response to inhalation of an antimicrobial spray containing TiO<sub>2</sub> particles.

### Publications and Abstracts

- Nurkiewicz TR, Porter DW, Barger M, Millecchia L, Rao KM, Marvar PJ, Hubbs AF, Castranova V, Boegehold MA [2007]. Systemic microvascular dysfunction and inflammation after pulmonary particulate matter exposure. *Environ Health Perspect* 114:412–419.
- Nurkiewicz TR, Porter DW, Hubbs AF, Millecchia L, Stone S, Chen BT, Frazer D, Castranova V, Boegehold M [2007]. Inhalation of ultrafine titanium dioxide augments particle-dependent microvascular dysfunction. *FASEB J* 21(6):A 846.
- Nurkiewicz TR, Porter DW, Hubbs AF, Cumpston JL, Chen BT, Frazer DG, Castranova V [2008]. Nanoparticle inhalation augments particle-dependent systemic microvascular dysfunction. *Part Fibre Toxicol* 5(1).
- LeBlanc A, Hu Y, Muller-Delp J, Moseley A, Chen B, Frazer D, Castranova V, Nurkiewicz T [2008]. Particulate matter inhalation impairs coronary microvascular reactivity. *Proc 25th Eur Soc Microcir Conf Budapest, Hungary, August 26–29*, pp. 13–17.

- Nurkiewicz TR, Porter DW, Hubbs AF, Chen BT, Frazer DG, Castranova V [2008]. Ultrafine particulate matter inhalation attenuates microvascular endothelial nitric oxide production. *Toxicologist* 102:A1255.
- Nurkiewicz TR, Porter DW, Hubbs AF, Tone S, Chen BT, Frazer DG, Boegehold MA, Castranova V [2009]. Pulmonary nanoparticle exposure disrupts systemic microvascular nitric oxide signaling. *Toxicol Sci* 110(1):191–203.
- LeBlanc AJ, Cumpston JL, Chen BT, Frazer D, Castranova V, Nurkiewicz TR [2009]. Nanoparticle inhalation impairs endothelium-dependent vasodilatation in subepicardial arterioles. *J Toxicol Environ Health Part A* 72:1576–1584.
- LeBlanc AL, Moseley AM, Chen BT, Frazer D, Castranova V, Nurkiewicz TR [2010]. Nanoparticle inhalation impairs coronary microvascular reactivity via a local reactive oxygen species-dependent mechanism. *Cardiovas Toxicol* 10:27–36.
- Knuckles TL, Frazer DG, Cumpston JL, Chen BT, Castranova V, Nurkiewicz TR [2010]. Nanoparticle inhalation modulates arteriolar sympathetic constriction: role of nitric oxide, prostanoids, and  $\alpha$ -adrenergic receptors. *Toxicologist* 114:1, A1728.
- Chen BT, Afshari A, Stone S, Jackson M, Schwegler-Berry D, Frazer D, Castranova V, Thomas TA [2010]. Nanoparticles-containing spray can aerosol: characterization, exposure assessment, and generator design. *Inhal Toxicol* 22:1072–1082.

### Invited Presentations

- Nurkiewicz TR, Porter DW, Barger M, Hubbs AF, Millecchia L, Rao K, Chen BT, Frazer D, Castranova V, Boegehold MA [2006]. Peripheral microvascular dysfunction follows ultrafine titanium dioxide inhalation. Health Effects Institute Annual Conference, San Francisco, California, April 9–11.
- Nurkiewicz TR, Porter DW, Hubbs AF, Millecchia LL, Donlin M, Chen TB, Frazer DG, Castranova V [2007]. Nanoparticle inhalation attenuates systemic microvascular endothelium-dependent nitric oxide production. World Congress for Microcirculation, Milwaukee, Wisconsin, August 15–19.
- Castranova V [2007]. Inhalation of ultrafine titanium dioxide augments particle-dependent microvascular dysfunction. Nanotoxicology Conference, Venice, Italy, April 20.
- Castranova V [2007]. Cardiovascular effects of pulmonary exposure to nanoparticles. Toxicology and Risk assessment conference, Cincinnati, Ohio, April 25.
- Castranova V [2007]. Inhalation of ultrafine titanium dioxide augments particle-dependent microvascular dysfunction. Center for Environmental Health, University of Montana, Missoula, Montana, September 21.





- Castranova V [2008]. Systemic microvascular effects of pulmonary exposure to fine vs. ultrafine particles. University of Connecticut, Storrs, Connecticut, April 7.
- Castranova V [2008]. Systemic microvascular effects of pulmonary exposure to fine vs. ultrafine particles. Meeting held at John Hopkins University, Baltimore, Maryland, June 10.
- Castranova V [2008]. Ambient particulates and/or nanoparticles: cardiovascular and pulmonary toxic and morphologic manifestations. International Conference on Particles: Risks and Opportunities, Cape Town, South Africa, September 2–5.
- Chen BT, McKinney W, Schwegler-Berry D, Castranova V, Frazer D [2008]. Aerosolization and characterization of multi-walled carbon nanotubes for inhalation studies. American Association for Aerosol Research Annual Conference, Orlando, Florida, October 20–24.
- Castranova V [2008]. Systemic microvascular effects of pulmonary exposure to particles. Presentation at the Harvard School of Public Health, Cambridge, Massachusetts, October 24.
- LeBlanc AF, Hu Y, Miller-Delp J, Chen D, Frazer BT, Castranova V, Nurkiewicz TR [2008]. Nanoparticle inhalation impairs endothelium-dependent vasoreactivity in coronary arterioles. American Heart Association Conference, Washington DC, November 8–12.
- Castranova V [2009]. Systemic microvascular dysfunction following pulmonary exposure to fine vs. ultrafine TiO<sub>2</sub>. EPA, Washington, DC, May 27.
- Castranova V [2009]. Systemic microvascular dysfunction following pulmonary exposure to fine vs. ultrafine TiO<sub>2</sub>. WV Nano 2009, Morgantown, West Virginia, May 11.
- Castranova V [2009]. Systemic microvascular dysfunction following pulmonary exposure to fine vs. ultrafine TiO<sub>2</sub>. American Industrial Hygiene Conference and Expo, Toronto, Canada, June 4.
- Castranova V [2009]. Effect of pulmonary exposure to particles on systemic microvascular response. University of Roma, Rome, Italy, August 24.
- Castranova V [2009]. Systemic microvascular response to pulmonary exposure to particles. NASA, Houston, Texas, December 8.
- Chen BT, JL Cumpston, AM Moseley, S Stone, D Schwegler-Berry, D Porter, AF Hubbs, Frazer D, Castranova V, Nurkiewicz TR [2009]. Particle-associated systemic microvascular dysfunction. 28th Annual Conference of the American Association for Aerosol Research, Minneapolis, MN, October 26–30.
- Chen BT, Afshar A, Stone S, Jackson M, McKinney M, Schwegler-Berry D, Frazer DG, Castranova V, Thomas T [2010]. Nanoparticle-containing spray can aerosol: characterization, exposure assessment, and inhalation chamber design. 29th Annual Conference of the American Association for Aerosol Research. Portland, OR, October 25–29.

## Project 5: Particle Surface Area as a Dose Metric

**Principal Investigator:** Vincent Castranova, PhD

**Project Duration:** FY 2004–2008

**Critical Topic Area:** Toxicology and internal dose

### Accomplishments and Research Findings

- Developed a method to improve dispersion of nanoparticles in biologically compatible suspension media.
- Determined that improved nanoparticle dispersion results in a greater inflammatory response after intratracheal instillation of ultrafine carbon black in rats.
- Compared ultrafine TiO<sub>2</sub> and carbon black to fine TiO<sub>2</sub> and carbon black, respectively, and determined that the ultrafine particles of both are more inflammogenic on a mass-dose basis.
- Determined that on an equivalent total particle surface area basis, the potencies of ultrafine versus fine TiO<sub>2</sub> or carbon black were not significantly different.
- Determined that pulmonary inflammation following intratracheal instillation of ultrafine TiO<sub>2</sub> was more persistent than after installation of ultrafine carbon black.
- Determined that in vitro treatment with ultrafine TiO<sub>2</sub> stimulates oxidant production and induction of molecular signaling events in macrophages.

### Publications and Abstracts

- Castranova V [2007]. Comparison of pulmonary responses to single-walled vs. multi-walled carbon nanotubes. *Toxicologist* 96(1):8.
- Oberdorster G, Maynard A, Donaldson K, Castranova V, Fitzpatrick J, Ausman K, Carter J, Karn B, Kreyling W, Lai D, Olin S, Monterio-Riviere N, Warheit D, Yang H [2005]. Principles for characterizing the potential human effects from exposure to nanomaterials: elements of screening strategy. *Particle Fibre Toxicol* 2:8.
- Oberdorster G, Maynard A, Donaldson K, Castranova V, Fitzpatrick J, Ausman K, Carter J, Karn B, Kreyling W, Lai D, Olin S, Monterio-Riviere N, Warheit D, Yang H [2005]. Principles for characterizing the potential human effects from exposure to nanomaterials: elements of a screening strategy. *Toxicology* 90:A2333.



- Sager T, Robinson VA, Porter DW, Schwegler-Berry DE, Lindsley W, Castranova V [2007]. An improved method to prepare suspensions of nanoparticles for treatment of lung cells in culture or in vivo exposure by pharyngeal aspiration or intratracheal instillation. *Toxicologist* 96(1):232.
- Sager T, Porter DW, Robinson VA, Lindsley WG, Schwegler-Berry DE, Castranova V [2007]. Improved method to disperse nanoparticles for in vitro and in vivo investigation of toxicity. *Nanotoxicity* 1(2):118–129.
- Shvedova AA, Sager T, Murray AR, Kisin E, Porter DW, Leonard SS, Schwegler-Berry D, Robinson VA, Castranova V [2007]. Critical issues in the evaluation of possible adverse pulmonary effects resulting from airborne nanoparticles. In: Monteiro-Riviere N, Tran L, eds. *Nanotechnology: characterization, dosing and health effects*. New York: Taylor and Francis.
- Sriram K, Porter DW, Tsuruoka S, Endo M, Jefferson AM, Wolfarth MG, Rogers GM, Castranova V, Luster MI [2007]. Neuroinflammatory responses following exposure to engineered nanomaterials. *Toxicologist* 96(1):288.
- Shvedova A, Sager T, Murray A, Kisin E, Porter D, Leonard SS, Schwegler-Berry D, Robinson V, Castranova V [2007]. Critical issues in the evaluation of possible effects resulting from airborne nanoparticles. In: Monteiro-Riviere NA, Tran CL, eds. *Nanotechnology: characterization, dosing, and health effects*. New York: Informa Healthcare USA Inc., pp. 221–232.
- Sager T, Porter D, Robinson V, Lindsley WG, Schwegler-Berry DE, Castranova V [2007]. An improved method to disperse nanoparticles for in vitro and in vivo investigation of toxicity. *Nanotoxicol* 1:118–129.
- Sager T, Robinson V, Porter D, Schwegler-Berry DE, Lindsley W, Castranova V [2007]. An improved method to prepare suspensions of nanoparticles for treatment of lung cells in culture or in vivo exposure by pharyngeal aspiration or intratracheal instillation. *Toxicologist* 96:A1120.
- Kang JL, Moon C, Lee HS, Park E-M, Kim HS, Castranova V [2008]. Comparison of the biological activity between ultrafine and fine titanium dioxide particles in RAW 264.7 cells associated with oxidative stress. *J Toxicol Environ Health* 71:478–485.
- Porter DW, Sriram K, Wolfarth MG, Jefferson AM, Schwegler-Berry DE, Andrew ME, Castranova V [2008]. A biocompatible medium for nanoparticle dispersion. *Nanotoxicology* 2:144–154.
- Kang JL, Moon C, Lee HS, Lee HW, Park E-M, Kim HS, Castranova V [2008]. Comparison of the biological activity between ultrafine and fine TiO<sub>2</sub> particles in RAW 264.7 cells associated with oxidative stress. *Toxicologist* 102:A1486.
- Sager T, Porter D, Castranova V [2008]. Pulmonary response to intratracheal instillation of fine or ultrafine carbon black or titanium dioxide: role of surface area. *Toxicologist* 102:A1491.

- Sager T, Kommineni C, Castranova V [2008]. Pulmonary response to intratracheal instillation of ultrafine versus fine titanium dioxide: role of surface area. *Particle Fibre Toxicol* 5:17.

### Invited Presentation

- Castranova V [2008]. Intratracheal instillation of rats to ultrafine TiO<sub>2</sub> or ultrafine carbon black. Presentation at the Health and Environmental Sciences Institute, Washington, DC, May 8.



## Project 6: Role of Carbon Nanotubes in Cardiovascular and COPD-Related Diseases

**Principal Investigator:** Aaron Erdely, PhD (Petia Simeonova, PhD, deceased)

**Project Duration:** FY 2004–2010

**Critical Topic Area:** Toxicology and internal dose

### Accomplishments and Research Findings

- Evaluated cardiovascular effects resulting from respiratory exposure to purified and MWCNT.
- A single exposure resulted in distressed mitochondrial homeostasis, an effect that was dose-dependent. Oxidative alterations of mitochondria can trigger endothelial dysfunction, a leading mechanism in atherosclerosis progression.
- Multiple pulmonary exposures of SWCNTS to apoE<sup>-/-</sup> mice, a model of human atherosclerosis, resulted in accelerated atherosclerosis.
- Respiratory exposure to SWCNTS and MWCNT resulted in acute and chronic systemic responses related to potential adverse cardiovascular effects.
- SWCNTS and MWCNT deposited in the lung induced acute systemic inflammatory and prothrombotic responses. These effects were portrayed by a complex pattern of gene expression and protein blood analyses indicating a close cross-talk between the lung and systemic circulation following pulmonary exposure.
- Developed methodological approach used in the above studies for evaluating toxicity of respiratory exposure to particles. The approach will foster the development of predictive tests for estimating the toxicity of new nanomaterials on the basis of their physicochemical characteristics and potential to induce oxidative stress, inflammation, and specific pulmonary and systemic toxicity. Study results demonstrated that the evaluation of systemic effects in parallel with pulmonary toxicity studies provide a more complete toxicological assessment that can be used in predicting risk.
- Osteopontin (OPN) is involved in granulomatous lung disease, of which CNT exposure is included. Immunohistochemistry showed markedly increased levels of OPN and the binding receptor CD44 following MWCNT exposure. Mice lacking the OPN gene were protected from some of the histological abnormalities caused by MWCNT. Increased circulating levels of OPN, a suggested biomarker for asbestos exposure, proved to be inconclusive.

- Discovered that endothelial cells exposed to CNTs resulted in a direct effect. The findings of this study demonstrated actin cytoskeleton disruption, VE-cadherin disorganization, reduced tubule formation, and concomitant diminished viability of human aortic endothelial cells as a result of exposure to purified SWCNTs or MWCNT. These effects were dose dependent and most likely associated with mechanical damage of the cell membrane. The endothelial cells tolerate acute low concentrations of CNTs without changes in the viability, cytoskeleton, and function.
- In vitro studies were conducted to explore the interaction between OPN and CD44. The exposure of RAW 264.7 cells, a murine macrophage cell line, to MWCNT or asbestos increased gene expression levels of OPN and CD44, protein release of OPN and modifications of the interactions between CD44 and OPN at cellular and extracellular levels in both a time- and dose-dependent manner.

### Publications and Abstracts

- Li Z, Salmen R, Hulderman T, Kisin E, Shvedova A, Luster M, Simeonova P [2004]. Pulmonary carbon nanotube exposure and oxidative status in vascular system. *Free Radical Biol Med* 37(1):S142.
- Li Z, Salmen R, Hulderman T, Kisin E, Shvedova AA, Luster MI [2005]. Pulmonary exposure to carbon nanotubes induces vascular toxicity. *Toxicologist* 84:A1045.
- Li ZJ, Chapman R, Hulerman T, Salmen R, Shvedova, A, Luster MI, Simeonova PP [2006]. Relationship of pulmonary exposure to multiple doses of single wall carbon nanotubes and atherosclerosis in apoE<sup>-/-</sup> mouse model. *Toxicologist* 90(1):A1555.
- Li Z, Hulderman T, Salmen R, Chapman R, Leonard SS, Shvedova A, Luster MI, Simeonova PP [2007]. Cardiovascular effects of pulmonary exposure to single-wall carbon nanotubes. *Environ Health Perspect* 115(3):77–82. \*\*\*Nominated for Charles C. Shepard Science Award, 2008, and was highlighted and discussed in the section Hot-off-the-Presses Peer-Reviewed Research Article of the EH&S Nano News [[www.ehsnanonews.com/](http://www.ehsnanonews.com/)] as one of the first investigations on the potential cardiovascular effects of pulmonary exposure to SWCNTs.
- Simeonava PP, Luster MI [2007]. In: Simeonova PP, Opopol N, Luster MI, eds. *Nanotechnology: toxicological issues and environmental safety, NATO security through science series book*. New York: Springer-Verlag.
- Simeonova PP [2007]. Nanoparticle exposure and cardiovascular effects—experimental data. In: Simeonova PP, Opopol N, Luster MI, eds. *Nanotechnology: toxicological issues and environmental safety, NATO security through science series book*. New York: Springer-Verlag, pp. 53–65.



- Simeonova PP, Erdely A, Li Z [2007]. Carbon nanotube exposure and risk for cardiovascular effects. In: Monteiro-Riviere NA, Tran CL, eds. *Nanotoxicology: characterization, dosing, and health effects*. New York: Informa Healthcare USA, Inc., pp. 237–246.
- Simeonova PP, Li Z, Erdely A [2007]. Carbon nanotube respiratory exposure and risk from systemic effects. *Toxicologist* 96(1):137.
- Erdely A, Hulderman T, Salmen R, Liston A, Zeidler-Erdely PC, Simeonova PP [2008]. Carbon nanotube acute lung exposure induces plasminogen activator inhibitor 1. *Toxicologist* 102(1):151.
- Erdely A, Hulderman T, Salmen R, Liston A, Zeidler-Erdely PC, Simeonova PP [2008]. Crosstalk between the lung and blood following carbon nanotube exposure; potential biomarkers and implications for cardiovascular disease. Allegheny-Erie Chapter meeting, Society of Toxicology. April 18. \*\*\* Awarded best overall poster.
- Erdely A, Hulderman T, Salmen R, Liston A, Zeidler-Erdely PC, Simeonova PP [2009]. Time course of systemic effects following a single exposure to carbon nanotubes. *Toxicologist* 108(1):279.
- Erdely A, Hulderman T, Salmen R, Liston A, Zeidler-Erdely P, Schwegler-Berry, Castranova V, Koyama, S, Kim Y-A, Endo M, Simeonova PP [2009]. Cross-talk between the lung and systemic circulation during carbon nanotube respiratory exposure. Potential biomarkers. *Nano Lett* 9(1):36–43. \*\*\*Nominated for Charles C. Shepard Science Award and the American Chemical Society Office of Public Affairs highlighted the paper in its weekly PressPac.
- Simeonova PP [2009]. Update on carbon nanotube toxicity. *Nanomedicine* 4(4):373–375.
- Simeonova PP, Erdely A [2009]. Engineered nanoparticle respiratory exposure and potential risks for cardiovascular toxicity: predictive tests and biomarkers. *Inhal Toxicol* 21(S1):68–73.
- Walker VG, Li Z, Hulderman T, Schwegler-Berry D, Kashon M, Simeonova PP [2009]. Potential in vitro effects of carbon nanotubes on human aortic endothelial cells. *Tox Appl Pharm* 236(3):319–328.
- Walker VG, Hulderman T, Simeonova PP [2009]. Carbon nanotube exposure induces cytotoxicity in human bronchial epithelial cells. *Toxicologist* 108(1):461.
- Walker VG, Hulderman T, Simeonova PP [2009]. Mechanism of multiwalled carbon nanotube- and asbestos-induced osteopontin/CD44 in raw 264 macrophages. *Mol Biol Cell* 20:2689.

### Invited Presentations

- Simeonova P, Li J, Luster MI, Shvedova A, Salmen R [2005]. Carbon nanotube exposure and cardiovascular outcomes. 2nd International Symposium on Nanotechnology and Occupational Health, Minneapolis, Minnesota, October 3–6.



- Simeonova PP [2006]. Nanomaterial exposure and risk for systemic effects. Toxicology and Risk Assessment Meeting, Cincinnati, Ohio, April 19.
- Simeonova PP [2007]. Carbon nanotube respiratory exposure and risk from systemic effects. Society of Toxicology, Charlotte, North Carolina, March 25–29.
- Simeonova PP [2007]. Carbon nanotubes—toxicological evaluation. International meeting of nanotechnology, San Francisco, California, November 5–7.
- Walker VG, Hulderman T, Simeonova PP [2008]. Direct exposure to carbon nanotube induces cellular changes in primary human endothelial cells. The American Society for Cell Biology Annual Meeting, San Francisco, California, December 13–17.
- Simeonova PP [2008]. Engineered nanoparticle respiratory exposure and potential risk for cardiovascular toxicity. International Inhalation Symposium, Hanover, Germany, June 11–15.
- Simeonova PP [2008]. Carbon nanotube pulmonary exposure—cardiovascular effects. American Association for the Advancement of Science Annual Meeting, Boston, Massachusetts, February 14–18.
- Simeonova PP [2008]. Air pollutants and atherosclerosis. Press briefing coordinated by the Director of the Office of Public Programs, American Association for the Advancement of Science, Boston, Massachusetts, February 14–18.
- Simeonova PP, Erdely A, Walker V [2008]. Reports on MWCNT systemic toxicity and discussions about collaborations with Dr. Endo and Japanese scientist delegation visiting NIOSH (Morgantown, West Virginia, March 2008).
- Erdely A [2009]. Systemic effects following exposure to carbon nanotubes. Society of Toxicology, Baltimore, Maryland, March 15–19.



## Project 7: Investigations of Multi-walled Carbon Nanotube Toxicity

**Principal Investigator:** Dale W. Porter, PhD

**Project Duration:** FY 2007–2011

**Critical Topic Area:** Toxicology and internal dose

### Accomplishments and Research Findings

- Developed and validated a biocompatible dispersion medium for use in nanotoxicology studies.
- Investigated crystal structure of MWCNT, using high-resolution transmission electron microscopy.
- Determined surface chemistry of the MWCNT, using x-ray photoelectron spectroscopy.
- Quantified metal contaminants and endotoxin levels present in MWCNT.
- Evaluated dispersion status of hydrosol MWCNT, using low-resolution transmission electron microscopy.
- Determined zeta potential of hydrosol MWCNT.
- Determined the length and diameter of MWCNT.
- Conducted an in vivo dose-response and time-course study of MWCNT-induced toxicity after exposure by pharyngeal aspiration.



Multi-walled carbon nanotubes in lungs 1 hour post aspiration

- Aspiration exposure study results indicate that MWCNT exposure induces dose- and time-dependent changes in pulmonary inflammation, damage, and fibrosis in the lung.
- Exposed mice by aspiration to gold-labeled MWCNT in order to determine MWCNT translocation.
- Built a MWCNT inhalation system in conjunction with the Developmental Engineering Research Team (DERT).
- Conducted a dose-response study to aerosolized MWCNT and found that inhaled MWCNT induces dose-dependent pulmonary inflammation and damage.
- A dose-response and time course study in mice exposed to MWCNT by pharyngeal aspiration was conducted.
- MWCNT caused pulmonary inflammation and damage which peaked at 7 days post-exposure and returned to control levels by 56 days post-exposure
- Histopathological studies determined that MWCNT exposure caused rapid development of pulmonary fibrosis, by 7 days post-exposure, and granulomatous inflammation persisted through 56 days post-exposure.
- MWCNT exposure caused lymphangiectasia, which is dilation of the pulmonary lymphatics.
- A morphometry study determined that MWCNT penetration of alveolar macrophages, the alveolar wall, and visceral pleura are both frequent and sustained, indicating a need to investigate the chronic toxicity of MWCNT at these sites.
- Pulmonary exposure to MWCNT increased hippocampal beta-amyloid (A $\beta$ ) protein content and caused hyper-phosphorylation of hippocampal Tau protein, indicative of Alzheimer's disease-like neuronal abnormality.
- Pulmonary exposure to MWCNT altered the mRNA expression of several blood-brain barrier (BBB) and glial-related markers, suggestive of BBB dysfunction.
- Pulmonary exposure to MWCNT altered the mRNA expression of several AD-related genes in the hippocampus, consistent with the increased expression of A $\beta$  and hyper-phosphorylated Tau in this region.
- Gene expression profiling studies have been conducted on mRNA isolated from lung samples obtained from this study.
- Partner in the International Alliance for NanoEHS Harmonization.

## Publications and Abstracts

- Sager TM, Porter DW, Robinson VA, Lindsley WG, Schwegler-Berry DE, Castranova V [2007]. Improved method to disperse nanoparticles for in vitro and in vivo investigation of toxicity. *Nanotoxicol* 1:118–129.



- Shvedova AA, Sager T, Murray AR, Kisin E, Porter DW, Leonard SS, Schwegler-Berry D, Robinson VA, Castranova V [2007]. Critical issues in the evaluation of possible adverse pulmonary effects resulting from airborne nanoparticles. In: Monteiro-Riviere NA, Tran CL, eds. *Nanotoxicology: characterization, dosing, and health effects*. New York: Informa Healthcare USA Inc., pp. 225–236.
- Sriram K, Porter DW, Tsuruoka S, Endo M, Jefferson AM, Wolfarth MG, Rogers GM, Castranova V, Luster MI [2007]. Neuroinflammatory responses following exposure to engineered nanomaterials. *Toxicologist* 96:A1390.
- Sager T, Robinson V, Porter DW, Schwegler-Berry D, Lindsley W, Castranova V [2007]. An improved method to prepare suspensions of nanoparticles for treatment of lung cells in culture or in vivo exposure by pharyngeal aspiration or intratracheal instillation. *Toxicologist* 96:A1120.
- Porter DW, Sriram K, Wolfarth M, Jefferson A, Schwegler-Berry D, Andrew ME, Castranova V [2008]. A biocompatible medium for nanoparticle dispersion. *Nanotoxicology* 2:144–154.
- Hubbs AF, Mercer RR, Sriram K, Castranova V, Chen BT, McKinney W, Frazer DG, Battelli L, Willard P, Scabilloni J, Schwegler-Berry D, Porter D [2008]. Acute respiratory toxicologic pathology of inhaled multi-walled carbon nanotubes. *Vet Pathol* 45:786.
- Wolfarth M, Porter DW, Hubbs AF, Leonard SS, Battelli LA, Andrew ME, Castranova V [2009]. Pulmonary toxicity of multi-walled carbon nanotubes. *Toxicologist* 108:457.
- Sriram K, Porter DW, Jefferson AM, Lin GX, Wolfarth M, Chen, McKinney W, Frazer DG, Castranova V [2009]. Neuroinflammation and blood-brain barrier changes following exposure to engineered nanomaterials. *Toxicologist* 108:458.
- Hubbs AF, Mercer RR, Coad JE, Battelli LA, Willard P, Sriram K, Wolfarth M, Castranova V, Porter DW [2009]. Persistent pulmonary inflammation, airway mucous metaplasia and migration of multi-walled carbon nanotubes from the lung after subchronic exposure. *Toxicologist* 108:457.
- Mercer RR, Hubbs AF, Scabilloni J, Wang L, Castranova V, Porter DW [2010]. Distribution and persistence of pleural penetrations by multi-walled carbon nanotubes. *Am J Respir Crit Care Med* 181(1):A3102.
- Porter DW, Hubbs AF, Mercer RR, Wu N, Wolfarth MG, Sriram K, Leonard S, Battelli L, Schwegler-Berry D, Friend S, Andrew M, Chen BT, Tsuruoka S, Endo M, Castranova V [2010]. Mouse pulmonary dose- and time-course responses induced by exposure to multi-walled carbon nanotubes. *Toxicology* 269:136–147.
- Mercer RR, Hubbs AF, Scabilloni JF, Wang L, Battelli LA, Schwegler-Berry D, Castranova V, Porter DW [2010]. Distribution and persistence of pleural penetrations by multi-walled carbon nanotubes. *Particle Fibre Toxicol* 7:28.

- Pacurari M, Qian Y, Hubbs A, Porter D, Wolfarth M, Luo D, Wan Y, Castranova V, Guo N [2011]. Multi-wall carbon nanotube (MWCNT)-induced gene expression in the mouse lung: implication of carcinogenesis risk. *Toxicologist* 120:253–254.
- Pacurari M, Qian Y, Porter DW, Wolfarth M, Wan Y, Luo D, Ding M, Castranova V, Guo NL [2011]. Multi-walled carbon nanotube-induced gene expression in the mouse lung: association with lung pathology. *Toxicol Applied Pharmacol* 255:18–31.
- Mercer RR, Hubbs AF, Scabilloni JF, Wang L, Battelli LA, Friend S, Castranova V, Porter DW [2011]. Pulmonary fibrotic response to aspiration of multi-walled carbon nanotubes. *Particle Fibre Toxicol* 8:21.
- Mercer R, Hubbs AF, Scabilloni JF, Rojanasakul L, Battelli LA, Castranova V, Porter DW [2011]. Pulmonary fibrotic response to sub-chronic multi-walled carbon nanotube exposure. *Toxicologist* 120:11.
- Sager TM, Wolfarth M, Porter D, Castranova V, Wu N, Holian A [2011]. Effect of surface modification on the bioavailability and inflammatory potential of multi-walled carbon nanotubes. *Toxicologist* 120:252.
- Battelli LA, Castranova V, Porter DW, Friend S, Schwegler-Berry D, Willard P, Hubbs AF [2011]. The use of E-cadherin immunofluorescence in pulmonary toxicologic pathology studies. *Toxicologist* 120:123.

### Invited Presentations

- Chen BT, McKinney W, Schwegler-Berry D, Castranova V, Frazer DG [2008]. Aerosolization and characterization of multi-walled carbon nanotubes for inhalation studies. American Association for Aerosol Research Annual Conference, Orlando, Florida, October 20–24.
- Porter DW [2009]. MWCNT toxicity in the lung. NIOSH (Morgantown, West Virginia), for the visiting Japanese METI Delegation, February 29.
- Porter DW [2009]. Pulmonary dose- and time course responses induced by exposure to multi-walled carbon nanotubes. US EPA, Washington, DC, November 9–10.
- Sriram K [2010]. Central nervous system effects of pulmonary exposure to nanoparticles. NTRC 2010 Update, Wheeling, West Virginia, April 20.
- Sriram K [2010]. Neurological risks of exposure to incidental and engineered nanoparticles. West Virginia University Center for Neuroscience, Morgantown, West Virginia, September 29.
- Porter WD [2011]. Introduction to nanotoxicology: an emerging field. Pittsburgh AIHA Local Section, Pittsburgh, Pennsylvania, April 6.



## Project 8: Toxicological Effects of Aerosolized MWCNT

**Principle Investigator:** Dale W. Porter, PhD

**Project Duration:** FY 2010–2012

**Critical Topic Areas:** Toxicology and internal dose

### Accomplishments and Research Findings

- Developmental Engineering Research Team (DERT) designed and tested an exposure chamber necessary for the studies in this project.
- Methodology to measure MWCNT lung burden was developed.
- A dose-response study to aerosolized MWCNT has been done and determined that pulmonary inflammation and damage are dose dependent at one day post-exposure.
- Inhalation exposure to MWCNT also elicited neuroinflammation in the olfactory bulb and hippocampus at one day post-exposure.
- A time course study (up to 48 weeks post-exposure) of pulmonary and central nervous system responses to inhalation of MWCNT is currently being conducted.
- For the time course study, pulmonary toxicity studies will examine MWCNT-induced pulmonary inflammation, damage, and fibrosis.
- For the time course study, neurotoxicity studies will evaluate the integrity of the blood-brain barrier (BBB), as well as neuroinflammatory and oxidative stress responses, and assess neuronal damage by biochemical and histological techniques to determine progressive neurodegenerative changes related to Alzheimer's-like pathology.
- A study to determine if exposure to aerosolized MWCNT induces lung cancer began in 2011.
- For the MWCNT cancer study, gross lung tumor counts and tumor size will be evaluated, and some tumors will be excised for comparative genomic hybridization (CGH) and expression analysis.
- A study to determine if exposure to aerosolized MWCNT induces mesothelioma is tentatively scheduled to begin in 2011.

### Publications and Abstracts

- Porter DW, Wolfarth M, Chen TB, McKinney W, Hubbs AF, Battelli LA, Andrew ME, Frazer DG, Castranova V [2009]. Pulmonary toxicity of inhaled multi-walled carbon nanotubes. *Toxicologist* 108:457.

- Sriram K, Porter DW, Jefferson AM, Lin GX, Wolfarth M, Chen TB, McKinney W, Frazer DG, Castranova V [2009]. Neuroinflammation and blood-brain barrier changes following exposure to engineered nanomaterials. *Toxicologist* 108:458.
- Wolfarth M, McKinney W, Chen TB, Castranova V, Porter DW [2011]. Acute pulmonary responses to MWCNT inhalation. *Toxicologist* 120:10.
- Hubbs AM, Castranova V, Chen TB, Frazer DG, McKinney W, Mercer RR, Kashon ML, Battelli LA, Willard P, Porter DW [2011]. Pulmonary inflammation, epithelial hyperplasia, and lymph node translocation after multi-walled carbon nanotube inhalation. *Toxicologist* 120:11.

### Invited Presentations

- Sriram K [2010]. Central nervous system effects of pulmonary exposure to nanoparticles. NTRC 2010 Update, Wheeling, West Virginia, April 20.
- Sriram K [2010]. Neurological risks of exposure to incidental and engineered nanoparticles. Presented at West Virginia University Center for Neuroscience, Morgantown, West Virginia, September 29.
- Porter DW [2011]. Introduction to nanotoxicology: an emerging field. Pittsburgh AIHA Local Section, Pittsburgh, Pennsylvania, April 6.
- Hubbs AF, Mercer R, Sargent L, Castranova V, Sriram K, Battelli LA, Porter DW [2011]. Nanoparticulate pathology. The American College of Veterinary Pathologists 62nd Annual Meeting, Nashville, TN, December 3–7.





## Project 9: Pulmonary Toxicity of Metal Oxide Nanospheres and Nanowires

**Principal Investigator:** Dale W. Porter, PhD

**Project Duration:** FY 2007–2011

**Critical Topic Area:** Toxicology and internal dose

### Accomplishments and Research Findings

- Developed and validated a biocompatible dispersion medium for use in nanotoxicology studies.
- TiO<sub>2</sub> nanospheres (NS), short nanobelts (NB1), and long nanobelts (NB2) were synthesized and used in these studies.
- Characterized physical (diameter, length, width) and crystal structure of the TiO<sub>2</sub> nanoparticles.
- Determined surface chemistry of the TiO<sub>2</sub> nanoparticles, using electron spin resonance spectroscopy.
- Evaluated dispersion status of hydrosol TiO<sub>2</sub> nanoparticles, using low-resolution transmission electron microscopy and dynamic light scattering.
- In vitro, NB2 induced inflammasome activation and release of inflammatory cytokines through a cathepsin B-mediated mechanism.
- Alveolar macrophages from MARCO null mice indicate that the MARCO receptor is involved in the binding and uptake of the NS but not NB1 or NB2.
- All three TiO<sub>2</sub> nanoparticles caused some degree of lipid peroxidation and, in comparison with controls, caused significant increases in intracellular reactive oxygen species.
- The in vitro studies indicate that relative toxicity of NS < NB1 < NB2.
- In vivo studies were conducted in mice exposed by pharyngeal aspiration to 0–30 µg/mouse to evaluate the effect of exposure to NS, NB1, and NB2 on the pulmonary and central nervous systems.
- NB1 and NB2 induced dose- and time-dependent increases in pulmonary inflammation and damage.
- By 28 days post-exposure, markers of pulmonary inflammation and damage had returned to control levels.
- Clearance of NS was greater than that of NB2 at 112 days post-exposure.
- Histopathology studies determined that NB2 caused pulmonary fibrosis.

- The data also suggest that NB2, but not NS, activates the NALP3 inflammasome.
- Overall, in vivo studies indicated relative pulmonary toxicity of NS < NB1 < NB2.
- Elemental analyses of titanium in brain following pulmonary exposure to NS or NB2 determined that NB2, in particular, resulted in a transient translocation of elemental titanium to the brain.
- NS, NB1, and NB2 (30- $\mu$ g dose) induced subtle neuroinflammation in the striatum and hippocampus regions of the brain at 1 day post-exposure, as determined by the expression of inflammatory cytokine (IL1b) and chemokine (Cxcl2). No significant differences in the relative toxicities of the three nanoparticles were observed.
- NS, NB1, and NB2 (30- $\mu$ g dose) caused downregulation of endothelin 2 (Edn2) at 1 day post-exposure that persisted through 112 days post-exposure, suggesting alterations in cerebral blood flow.

## Publications and Abstracts

- Sager TM, Porter DW, Robinson VA, Lindsley WG, Schwegler-Berry DE, Castranova V [2007]. Improved method to disperse nanoparticles for in vitro and in vivo investigation of toxicity. *Nanotoxicology* 1:118–129.
- Sager T, Robinson V, Porter DW, Schwegler-Berry D, Lindsley WG, Castranova V [2007]. An improved method to prepare suspensions of nanoparticles for treatment of lung cells in culture or in vivo exposure by pharyngeal aspiration or intratracheal instillation. *Toxicologist* 96:A1120.
- Porter DW, Sriram K, Wolfarth M, Jefferson A, Schwegler-Berry D, Andrew ME, Castranova V [2008]. A biocompatible medium for nanoparticle dispersion. *Nanotoxicology* 2:144–154.
- Porter DW, Holian A, Sriram K, Wu N, Wolfarth M, Hamilton R, Buford M [2008]. Engineered titanium dioxide nanowire toxicity in vitro and in vivo. *Toxicologist* 102:306.
- Hamilton RF Jr, Wu N, Porter D, Buford M, Wolfarth M, Holian A [2009]. Particle length-dependent titanium dioxide nanomaterials' toxicity and bioactivity. *Particle Fibre Toxicol* 6:35.
- Sriram K, Porter DW, Jefferson AM, Lin GX, Wolfarth M, Chen TB, McKinney M, Frazer DG, Castranova V [2009]. Neuroinflammation and blood-brain barrier changes following exposure to engineered nanomaterials. *Toxicologist* 108: 458.
- Yang RS, Porter DW [2011]. Efficient design of biological experiments for dose-response modeling in toxicology studies. *Toxicologist* 120:102.



- Porter DW, Wolfarth MG, Wu N, Holian A, Hubbs A, Funk KA, Castranova V [2011]. Effect of engineered titanium dioxide nanoparticle shape on toxicity in vivo. *Toxicologist* 120:312.

### Invited Presentations

- Hamilton R, Porter DW, Buford M, Sriram K, Wu N, Wolfarth M, Holian A [2008]. Engineered titanium dioxide nanoparticle bioactivity and toxicity are dependent on particle length and shape. *Nanotoxicology—Second International Conference*, Zurich, Switzerland, September 7–10.
- Sriram K [2010]. Central nervous system effects of pulmonary exposure to nanoparticles. *NTRC 2010 Update*, Wheeling, West Virginia, April 20.
- Sriram K [2010]. Neurological risks of exposure to incidental and engineered nanoparticles. *West Virginia University Center for Neuroscience*, Morgantown, West Virginia, September 29.
- Porter DW [2011]. Introduction to nanotoxicology: an emerging field. *Pittsburgh AIHA Local Section*, Pittsburgh, Pennsylvania, April 6.

## Project 10: WC-Co Nanoparticles in Initiating Angiogenesis by Reactive Oxygen Species

**Principal Investigator:** Min Ding, PhD

**Project Duration:** FY 2008–2011

**Critical Topic Area:** Toxicology and internal dose

### Accomplishments and Research Findings

- This project investigated the potential pulmonary carcinogenesis in response to tungsten carbide–cobalt (WC-Co) particles exposure, with cell culture and an animal model.
- CEM assay showed that both fine particles and nanoparticles of WC-Co stimulate angiogenesis.
- The mechanistic investigations (gene mutation, activation of transcription factors, reactive oxygen species [ROS] generation) indicate that WC-Co nanoparticles induce ROS production, which activates AKT and ERK signaling pathways in lung epithelial cells.
- ROS production results in transcriptional activation of AP-1, NF- $\kappa$ B, and VEGF through AKT and ERK1/2 activation, with the greater effect observed in nanoscale WC-Co, in comparison with fine-sized WC-Co at the same concentration.

### Publications and Abstracts

- Ding M, Kisin ER, Zhao J, Bowman L, Lu Y, Jiang B, Leonard S, Vallyathan V, Castranova V, Murray AR, Fadeel B, Shvedova AA [2009]. Size-dependent effects of tungsten carbide–cobalt particles on oxygen radical production and activation of cell signaling pathways in murine epidermal cells. *Toxicol Appl Pharmacol* 241(3):260–268.
- Zhang XD, Zhao J, Bowman L, Shi X, Castranova V, Ding M [2010]. Tungsten carbide–cobalt particles activate Nrf2 and its downstream target genes in JB6 cells possibly by ROS generation. *J Environ Pathol Toxicol Oncol* 29(1):31–40.
- Shvedova AA, Kisin E, Murray A, Zhao J, Bowman LL, Lu Y, Jiang B, Leonard SS, Vallyathan V, Castranova V, Fadeel B, Ding M [2010]. Size-dependent effects of tungsten carbide–cobalt particles on induction of oxidative stress and activation of cell signaling pathways in vitro. *Toxicologist* 114(1):59.



## Invited Presentations

- Ding M, Zhao JS, Bowman L, Leonard S, Lu YJ, Vallyathan V, Castranova V, Shvedova A [2008]. Induction of AP-1-MAPKs and NF-kB signal pathways by tungsten carbide–cobalt particles. Poster presentation at Society of Toxicology's 47th Annual Meeting, Seattle, Washington, March 16–20.
- Zhang X, Zhao J, Bowman L, Shi X, Castranova V, Ding M [2008]. Nano-sized tungsten carbide–cobalt particles induced Nrf2 signaling and phase ii enzyme activity. Poster presentation at 5th Conference on Molecular Mechanisms of Metal Toxicity and Carcinogenesis, Morgantown, West Virginia, September 20–22.
- Ding M, Zhang X-D, Zhao J-S, Bowman L, Shi X, Castranova V [2009]. Tungsten carbide–cobalt particles activate Nrf2 signaling pathway in JB6 cells. Presented at 4th International Conference on Oxidative/Nitrosative Stress and Disease, New York, New York, October 27–30.
- Zhao J, Bowman L, Leonard S, Shi X, Castranova V, Ding M [2009]. Tungsten carbide–cobalt (WC-Co) induces apoptosis in JB6 cells by generation of ROS and FAS-FADD/mitochondrial signal pathways. 4th International Conference on Oxidative/Nitrosative Stress and Disease, New York, New York, October 27–30.
- Ding M, Zhao J, Bowman L, Castranova V, Jiang B-H [2010]. Tungsten carbide–cobalt nanoparticles induce angiogenesis through reactive oxygen species, AKT, ERK, and VEGF signal pathways. NTRC meeting, Olgebay, West Virginia, April 19–21.
- Ding M, Liu L-Z, Castranova V, Shi X, Flynn D, Biang B-H [2010]. Tungsten carbide–cobalt nanoparticles induce AKT, ERK, AP-1, NF-kB, VEGF, and angiogenesis. 2010 Experimental Biology (EB) Meeting, Anaheim, California, April 23–28.

## Project 11: Evaluation of the Pulmonary Deposition and Translocation of Nanomaterials

Principal Investigator: Robert R. Mercer, PhD

Project Duration: FY 2006–2011

Critical Topic Area: Toxicology and internal dose

### Accomplishments and Research Findings

- Found that aggregates of SWCNTS disperse when deposited in the lungs.
- Demonstrated that diffuse interstitial fibrosis following exposure to SWCNTS is due to a dispersed submicron form of SWCNTS that had not yet been identified.
- Demonstrated that injury response (time course and resulting lesions) from the inhalation of SWCNTS is similar to that produced by the aspiration of SWCNTS, a less costly and more feasible delivery method.

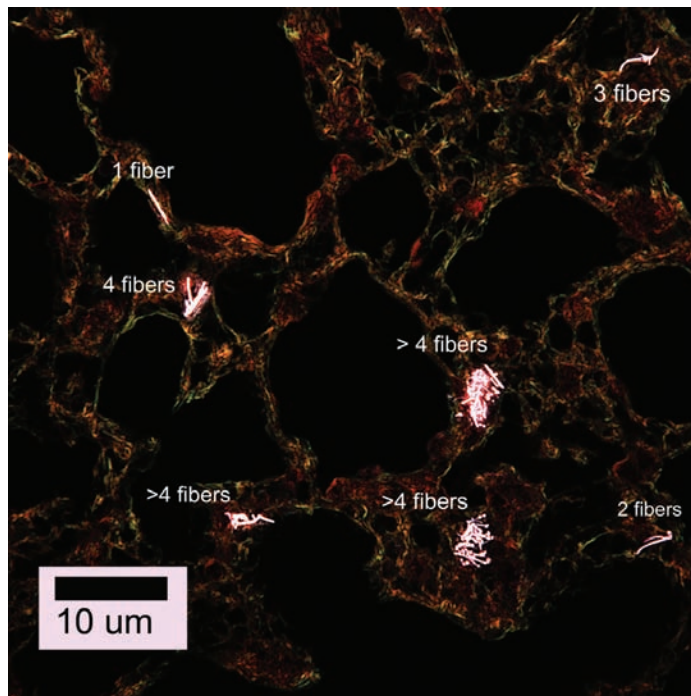

Lung tissue of the MWCNT-exposed mouse



- Received the 2008 Charles C. Shepard Science Award for outstanding scientific paper, *Alteration of Deposition Pattern and Pulmonary Response as a Result of Improved Dispersion of Aspirated Single-Walled Carbon Nanotubes in a Mouse Model*.
- Developed methods for labeling and identification of CNTs and other nanoparticles so that their potential translocation from the lungs to other organs can be studied.
- Demonstrated that injury response (time course and resulting lesions) from the inhalation of SWCNTS is similar to that produced by the aspiration of SWCNTS, a less costly and more feasible delivery method.
- 2008 paper “Inhalation vs. Aspiration of Single-Walled Carbon Nanotubes in C57BL/6 Mice: Inflammation, Fibrosis, Oxidative Stress, and Mutagenesis” won the 2009 Alice Hamilton Award for Outstanding Scientific Paper
- Demonstrated that MWCNT are transported to the pleura surface and subsequently determined the time course and persistence of MWCNT transport to the pleura.

### Publications and Abstracts

- Shvedova AA, Kisin ER, Mercer R, Murray AR, Johnson VJ, Potapovich AI, Tyurina YY, Gorelik O, Arepalli S, Schwegler-Berry D, Hubbs AF, Antonini J, Evans DE, Ku BK, Ramsey D, Maynard A, Kagan VE, Castranova V, Baron P [2005]. Unusual inflammatory and fibrogenic pulmonary responses to single walled carbon nanotubes in mice. *Am J Physiol Lung Cell Mol Physiol* 289:698–708.
- Kagan VE, Tyurina YY, Tyurin VA, Konduru NV, Potapovich AI, Osipov AN, Kisin ER, Schwegler-Berry D, Mercer RR, Castranova V, Shvedova AA [2006]. Direct and indirect effects of single walled carbon nanotubes on RAW 264.7 macrophages: role of Iron. *Toxicol Lett* 165:88–100.
- Mercer RR, Scabilloni JF, Wang L, Schwegler-Berry D, Shvedova A, Castranova V [2007]. Dispersion significantly enhances the pulmonary toxicity of single walled carbon nanotubes. *Toxicologist* 96(1):231.
- Roberts JR, Mercer RR, Young S-H, Porter DW, Castranova V, Antonini JM [2007]. Inflammation and fate of quantum dots following pulmonary treatment of rats. *Toxicologist* 96(1):230.
- Mercer RR, Scabilloni JF, Wang L, Battelli LA, Castranova V [2008]. Use of labeled single-walled carbon nanotubes to study acute translocation from the lungs. *Toxicologist* 102(S-1):A1399.
- Wang L, Castranova V, Rojanasakul Y, Lu Y, Scabilloni JF, Mercer RR [2008]. Direct fibrogenic effects of dispersed single-walled carbon nanotubes on human lung fibroblasts. *Toxicologist* 102(S-1):A1499.



- Wang L, Chanvorachote P, Toledo D, Stehlik C, Mercer RR, Castranova V, Rojanasakul Y [2008]. Hydrogen peroxide is a key mediator of Bcl-2 down regulation and apoptosis induction by cisplatin in human lung cancer cells. *Mol Cancer Thera Mol Pharmacol* 73:119–127.
- Mercer RR, Scabilloni J, Wang L, Kisin E, Murray A, Schwegler-Berry D, Shvedova A, Castranova V [2008]. Alteration of deposition pattern and pulmonary response as a result of improved dispersion of aspirated single-walled carbon nanotubes in a mouse model. *Am J Physiol Lung Cell Mol Physiol* 294:L87–L97.
- Shvedova AA, Kisin E, Murray E, Johnson V, Gorelik O, Arepalli S, Hubbs AF, Mercer RR, Keohavong P, Sussman N, Jin J, Stone S, Chen BT, Deye G, Maynard A, Castranova V, Baron P, Kagan VE [2008]. Inhalation versus aspiration of single-walled carbon nanotubes in C57BL/6 mice: inflammation, fibrosis, oxidative stress, and mutagenesis. *Am J Physiol Lung Cell Mol Physiol* 295:552–565.
- Wang L, Rojanasakul Y, Castranova V, Qiu A, Lu Y, Scabilloni JF, Wu N, Mercer RR [2010]. Direct fibrogenic effects of dispersed single-walled carbon nanotubes on human lung fibroblasts. *J Toxicol Environ Health A* 73:410–422.
- Porter DW, Hubbs AF, Mercer RR, Wu N, Wolfarth MG, Sriram K, Leonard SS, Battelli L, Schwegler-Berry D, Friend S, Andrew M, Chen BT, Tsuroka S, Endo M, Castranova V [2010]. Mouse pulmonary dose and time course responses induced by exposure to multi-walled carbon nanotubes. *Toxicology* 269:136–147.
- Ma JY, Zhao H, Mercer RR, Barger M, Murali R, Meighan T, Schwegler-Berry D, Castranova V, Ma JK [2011]. Cerium oxide nanoparticles–induced pulmonary inflammation and alveolar macrophage functional change in rats. *Nanotechnology* 5(3):312–325.
- Wang L, Castranova V, Mishra A, Chen B, Mercer RR, Schwegler-Berry B, Rojanasakul Y [2010]. Dispersion of single-walled carbon nanotubes by a natural lung surfactant for pulmonary in vitro and in vivo toxicity studies. *Part Fibre Toxicol (Epub)* 7:31.
- Mercer RR, Hubbs AF, Scabilloni JF, Wang LY, Battelli LA, Schwegler-Berry D, Castranova V, Porter D [2010]. Distribution and persistence of pleural penetrations by multi-walled carbon nanotubes. *Part Fibre Toxicol (Epub)* 7:28.
- Hubbs AF, Mercer R, Benkovic S, Harkema J, Sriram K, Schwegler-Berry DE, Goravanahally M, Nurkiewicz T, Castranova V, Sargent L [2011]. Nanotoxicology, a pathologist’s perspective. *Toxicol Pathol* 39(2):301–324.
- Pacurari M, Schwegler-Berry D, Friend S, Leonard SS, Mercer RR, Vallyathan V, Castranova V [2011]. Raw single-walled carbon nanotube–induced cytotoxic effects in human bronchial epithelial cells: comparison to asbestos. *Toxicological Environ Chem* 93:1045–1072.



- Mercer RR, Hubbs AF, Scabilloni JF, Wang LY, Battelli LA, Friend S, Castranova V, Porter DW [2011]. Pulmonary fibrotic response to aspiration of multi-walled carbon nanotubes. *Part Fibre Toxicol (Epub)* 8:21.
- Castranova V, Mercer RR [2011]. Responses to pulmonary exposure to carbon nanotubes. In: Donaldson, Duffin, Bonner, Poland, eds. *The toxicology of carbon nanotubes*. New York, NY: Cambridge University Press, pp. 1–22.

### Invited Presentations

- Mercer RR [2007]. Inhalation toxicology of SWCNTs. Society for Risk Assessment Teleseminar, June 7.
- Mercer RR [2008]. Using labeled SWCNT to determine potential acute translocation from the lungs. Society of Toxicology Annual Meeting, March 16–20.
- Mercer RR, Scabilloni JF, Wang L, Battelli LA, Castranova V [2009]. Use of labeled single walled carbon nanotubes to study translocation from the lungs. Society of Toxicology, Baltimore, Maryland, March 16. *Toxicologist* 108(S-1):A2192.
- Mercer RR, Hubbs AF, Scabilloni JF, Wang L, Castranova V, Porter D [2010]. Distribution and persistence of pleural penetrations by multi-walled carbon nanotubes. American Thoracic Society, New Orleans, Louisiana, May 16. *Am J Respir Crit Care Med* 181:A3102.

## Project 12: Occupational Exposures and Potential Neurological Risks

**Principal Investigator:** Krishnan Sriram, PhD

**Project Duration:** FY 2008–2012

**Critical Topic Area:** Toxicology and internal dose

### Accomplishments and Research Findings

#### 1. Welding fumes study

- Repeated-dose (1/week x 28 weeks) pulmonary exposures to fumes generated by gas metal arc–mild steel (GMA-MS) and manual metal arc–hardsurfacing (MMA-HS) welding have been completed.
- Demonstrated that repeated pulmonary exposure to GMA-MS or MMA-HS welding fumes caused loss of tyrosine hydroxylase protein, a marker of dopaminergic neurons.
- Demonstrated that repeated pulmonary exposure to GMA-MS or MMA-HS welding fumes altered the expression of specific Parkinson’s disease (PD)–related (Park) proteins, loss-of-function mutations of which have been linked to familial forms of PD. As there is a concern that welding fume exposure may accelerate the onset of Parkinsonism among welders, the current findings may provide early clues to the pathogenesis of the disease. Further, as the loss of these Park proteins preceded any observable neurobehavioral or neuropathological abnormalities, their utility as early predictors (biomarkers) of welding fume–associated dopaminergic dysfunction is promising.
- The study demonstrating the role of Park genes in the neurological effects of welding fumes won the 2011 Alice Hamilton Award in the Biological Sciences Category and was also nominated for the 2011 Charles Shepard Award.
- The work on the role of Park genes in the neurological effects of welding fumes was highlighted in Science News magazine’s feature article, entitled *Destination Brain: Inhaled Pollutants May Inflamm More Than the Lungs* (May 22, 2010;177(11):16), and in a feature article entitled *Dirty Minds*, published by the Australian science magazine COSMOS (March 2011:37) <http://www.cosmosmagazine.com/features/print/4268/dirty-minds>.
- Demonstrated that following repeated pulmonary exposure to welding fumes, Mn levels in the nails appeared to specifically reflect the pattern of accumulation in the brain but not the lung, liver, heart, or kidney. These findings suggest that nail Mn has the potential to be a sensitive and reliable biomarker for WF-related manganese intoxication and neurotoxicity.



- Short-term inhalation exposure (5d/week x 2 weeks) to gas metal arc–Stainless Steel (GMA-SS) under regular voltage (RVSS; 25V) and high voltage (HVSS; 30V) conditions has been studied.
- Demonstrated that short-term inhalation exposure to GMA-SS fumes generated at high voltage (HVSS) fails to elicit a neurotoxic response compared to that generated at regular voltage (RVSS). The lack of neurotoxicity was linked to the reduced solubility of Mn in the HVSS fumes.
- Three important findings have emerged from ongoing neurotoxicology studies conducted with the welding fumes. First, our findings of the involvement of Park genes in the neurotoxicity of welding fumes provides scope for evaluating these factors as potential biomarkers of adverse welding fume exposures. Second, our findings of the lack of neurotoxicity of GMA-SS fumes upon altering process conditions, i.e., high voltage, suggest that simple modifications of process parameters may alter the fume profile and thereby its toxicological properties. As welding process conditions can be easily controlled at the workplace, such efforts may contribute to prevention of adverse exposures and associated neurological risks. Third, our findings that accumulation of Mn in nails selectively reflects the pattern of brain Mn accumulation, but not Mn accumulation in other organs, suggest that nail can serve as a reliable surrogate to monitor WF-related manganese intoxication and neurotoxicity.

## 2. Carbon nanotubes study

- Single-dose pulmonary exposure (pharyngeal aspiration) to MWCNT has been completed. Dose-response and time-course studies have been completed.
- Pulmonary exposure to MWCNT altered the expression of several blood-brain barrier (BBB) and glial-related markers suggestive of BBB dysfunction.
- Pulmonary exposure to MWCNT increased hippocampal beta-amyloid (A $\beta$ ) protein content and caused hyper-phosphorylation of hippocampal Tau protein, indicative of Alzheimer's disease-like neuronal abnormality.
- Pulmonary exposure to MWCNT altered the expression of several AD-related genes in the hippocampus, consistent with the increased expression of A $\beta$  and hyper-phosphorylation of Tau in this region.
- Short-term whole-body inhalation exposures (2, 4, 8, and 12 days) to MWCNT aerosol have been completed.
- Demonstrated that short-term whole-body inhalation exposure to MWCNT elicited neuroinflammation in the olfactory bulb and hippocampus, findings consistent with observations following pulmonary (pharyngeal aspiration) exposure.
- Post-exposure recovery studies (up to 48 weeks post-exposure) to determine the persistence or progression of MWCNT-mediated neurotoxicity is ongoing.

- An important finding that has emerged is that exposure to multi-walled carbon nanotubes (MWCNT) may pose a neurological risk, causing Alzheimer's-like cellular/molecular aberrations that could potentially culminate in neurodegeneration. These findings call for extensive safety evaluation of carbon-based engineered nanomaterials to avert adverse human health effects.

### 3. Titanium dioxide study

- Single-dose pulmonary exposures (pharyngeal aspiration) to nanosphere titanium dioxide and nanowire titanium dioxide have been completed. Brain samples from dose-response (7.5–30 µg) and time-course (1–112 days post-exposure) studies have been collected.
- Elemental analyses of titanium in lung and brain following pulmonary exposure to nanosphere titanium dioxide and nanowire titanium dioxide have been completed.
- Determined that pulmonary exposure to nanowire titanium dioxide, in particular, resulted in a transient translocation of elemental titanium to the brain.

### Publications and Abstracts

- Sriram K, Porter DW, Tsuruoka S, Endo M, Jefferson AM, Wolfarth MG, Rogers GM, Castranova V, Luster MI [2007]. Neuroinflammatory responses following exposure to engineered nanomaterials. Society of Toxicology Annual Meeting, Charlotte, North Carolina, March 25–29. *Toxicologist* 96(1):288.
- Antonini JM, Roberts JR, Sriram K, Benkovic SA, O'Callaghan JP, Miller DB [2008]. Extrapulmonary tissue distribution of metals following repeated lung exposures to welding fumes with different elemental profiles. Society of Toxicology Annual Meeting, Seattle, Washington, March 16–20. *Toxicologist* 102(1):226.
- Porter DW, Holian A, Sriram K, Wu N, Wolfarth M, Hamilton R, Buford M [2008]. Engineered titanium dioxide nanowire toxicity in vitro and in vivo. Society of Toxicology Annual Meeting, Seattle, Washington, March 16–20. *Toxicologist* 102(1):306.
- Porter D, Sriram K, Wolfarth M, Jefferson A, Schwegler-Berry D, Andrew ME, Castranova V [2008]. A biocompatible medium for nanoparticle dispersion. *Nanotoxicology* 2(3):144–154.
- Hubbs AF, Mercer RR, Sriram K, Castranova V, Chen BT, McKinney W, Frazer DG, Battelli L, Willard P, Scabilloni J, Schwegler-Berry D, Porter D [2008]. Acute respiratory toxicologic pathology of inhaled multi-walled carbon nanotubes. *Vet Pathol* 45:786.
- Antonini JM, Sriram K, Benkovic SA, Roberts JR, Stone S, Chen BT, Schwegler-Berry D, Jefferson AM, Billig BK, Felton CM, Hammer MA, Ma F, Frazer DG, O'Callaghan JP, Miller DB [2009]. Mild steel welding fume



causes manganese accumulation and subtle neuroinflammatory changes but not overt neuronal damage in discrete brain regions of rats after short-term inhalation exposure. *Neurotoxicology* 30:915–925.

- Hubbs A, Mercer RR, Coad JE, Battelli LA, Willard PA, Sriram K, Wolfarth M, Castranova V, Porter DW [2009]. Persistent pulmonary inflammation, airway mucous metaplasia and migration of multiwalled carbon nanotubes from the lung after subchronic exposure. *Toxicologist* 108(1):457.
- Sriram K, Porter DW, Jefferson AM, Lin GX, Wolfarth MG, Chen BT, McKinney W, Frazer DG, Castranova V [2009]. Neuroinflammation and blood-brain barrier changes following exposure to engineered nanomaterials. *Toxicologist* 108(1):458.
- Sriram K, Lin GX, Jefferson AM, Wirth O, Hayashi Y, Roberts JR, Chapman RS, Krajnak KM, Antonini JM [2009]. Welding fume-related dopaminergic neurotoxicity. *Parkinsonism & Related Disorders* 15(2):S162.
- Sriram K, Lin GX, Jefferson AM, Roberts JR, Stone S, Chen BT, Frazer DG, Soukup JM, Ghio AJ, Antonini JM [2009]. Dopaminergic neurotoxicity following exposure to manganese-containing welding fumes. Program No. 154.26. 2009 Neuroscience Meeting Planner. Chicago, IL: Society for Neuroscience (Online).
- Sriram K, Lin GX, Jefferson AM, Roberts JR, Chapman RS, Chen BT, Soukup JM, Ghio AJ, Antonini JM [2010]. Dopaminergic neurotoxicity following pulmonary exposure to manganese-containing welding fumes. *Arch Toxicol* 84(7):521–540.
- Sriram K, Lin GX, Jefferson AM, Roberts JR, Wirth O, Hayashi Y, Krajnak KM, Soukup JM, Ghio AJ, Reynolds SH, Castranova V, Munson AE, Antonini JM [2010]. Mitochondrial dysfunction and loss of Parkinson's disease-linked proteins contribute to neurotoxicity of manganese-containing welding fumes. *FASEB J* 24:4989–5002.
- Antonini JM, Roberts JR, Chapman R, Soukup JM, Ghio AJ, Sriram K [2010]. Pulmonary toxicity and extrapulmonary tissue distribution of metals after repeated exposure to different welding fumes. *Inhal Toxicol* 22(10):805–816.
- Porter DW, Hubbs AF, Wu N, Wolfarth MG, Mercer R, Sriram K, Leonard S, Battelli L, Schwegler-Berry D, Friend S, Andrew M, Castranova V [2010]. Mouse pulmonary dose- and time-course responses induced by exposure to multi-walled carbon nanotubes. *Toxicology* 269:136–147.
- Antonini JM, Chen BT, Stone S, Roberts JR, Schwegler-Berry D, Chapman R, Moseley A, Cumpston JL, Leonard H, Keane M, Frazer DG, Sriram K [2010]. Alterations in welding process parameters change particle characteristics and influence lung responses. *Am J Respir Crit Care Med* 181:A1746.
- Antonini JM, Roberts JR, Sriram K. Nail manganese as a biomarker of welding fume exposure [2011]. 50th Annual Meeting of the Society of Toxicologists, Washington DC, March 7–12. *Toxicologist* 120(Suppl 2):499.

- Antonini JM, Keane M, Chen BT, Stone S, Roberts JR, Schwegler-Berry D, Andrews RN, Frazer DG, Sriram K [2011]. Alterations in welding process voltage affect the generation of ultrafine particles, fume composition, and pulmonary toxicity. *Nanotoxicology* 5(4):700–710.
- Sriram K, Lin GX, Jefferson AM, Roberts JR, Andrews RN, Kashon ML, Antonini JM [2012]. Manganese accumulation in nail clippings as a biomarker of welding fume exposure and neurotoxicity. *Toxicology* 291(1–3):73–82.

### Invited Presentations

- Sriram K [2010]. Dopaminergic neurotoxicity following exposure to manganese-containing welding fumes. Neurological responses after exposure to inhaled metal particles [symposium], 49th Annual Meeting of the Society of Toxicology, Salt Lake City, Utah, March 08.
- Sriram K [2010]. Central nervous system effects of pulmonary exposure to nanoparticles. Invited talk at the NIOSH NTRC 2010 Update, Wheeling, West Virginia, April 20.
- Sriram K [2010]. Neurological risks of exposure to incidental and engineered nanoparticles. Invited talk at the Center for Neuroscience, West Virginia University, Morgantown, West Virginia, September 29.





## Project 13: Lung Effects of Resistance Spot Welding with Adhesives

**Principal Investigator:** James Antonini, PhD

**Project Duration:** FY 2007–2010

**Critical Topic Area:** Toxicology and internal dose

### Accomplishments and Research Findings

- Designed a resistance spot welding generator for animal inhalation studies.
- Completed construction of the resistance spot welding generator.
- Characterized the physical and chemical properties of aerosols generated after heating.
- Completed short-term animal exposure study.

### Publications and Abstracts

- Afshari AA, Antonini JM, Castranova V, Boylstein R, Kanwal R, Frazer DG [2008]. Design of an inhalation exposure system to study resistance spot welding fume characteristics and biological effects. Society of Toxicology Annual Meeting, Seattle, Washington, March 16–20. *Toxicologist* 102:226.
- Afshari AA, Chen BT, Schwegler-Berry D, Cumpston MJ, Cumpston A, Leonard D, Friend S, Zeidler-Erdely PC, Frazer DG, Antonini JM [2011]. Characterization of welding aerosols generated by resistance spot welding. Society of Toxicology Annual Meeting, Washington, DC, March 8–10. *Toxicologist* 120:120–121.
- Zeidler-Erdely PC, Afshari AA, Meighan TG, McKinney W, Chen BT, Schwegler-Berry D, Jackson M, Cumpston A, Cumpston JL, Leonard HD, Erdely A, Frazer DG, Antonini JM [2012]. Pulmonary responses after inhalation of resistance spot welding fume using adhesives. Society of Toxicology Annual Meeting, San Francisco, California, March 2012. *Toxicologist* 126(1):226–227.

### Invited Presentations

- Chen BT, Stone S, Schwegler-Berry D, Frazer A, Donlin M, Cumpston J, Afshari A, Frazer D, Castranova V, Antonini JM [2007]. Characterization of welding fume particles generated from a robotic welding system. American Association for Aerosol Research Annual Conference, Reno, Nevada, September 24.
- Antonini J [2009]. Health effects of welding. American Industrial Hygiene Association Annual Meeting: AIHce 2009, Toronto, Ontario, June 2.

## Project 14: Neurotoxicity after Pulmonary Exposure to Welding Fumes

**Principal Investigator:** James Antonini, PhD

**Project Duration:** FY 2007–2010

**Critical Topic Area:** Toxicology and internal dose

### Accomplishments and Research Findings

- Characterized the physical properties of aerosol generated by welding and observed a significant number of welding particles in the nanoparticle-size range.
- Observed that, after inhalation, stainless steel particles persist in the lung and induce greater lung damage than mild steel particles.
- Observed the translocation of metals associated with welding fumes (e.g., manganese and chromium) to other organ systems, including specific regions of the brain.
- Observed some alterations in inflammatory mediators in brain tissue from specific lung regions.
- Observed molecular alterations in inflammatory mediators, impairment of mitochondrial function, loss of tyrosine hydroxylase, and altered expression of different Parkin (Park2, Park5, and Park7) genes in dopaminergic brain areas after repeated exposure to welding fumes.
- Recognized by CDC Charles C. Shepard Science Award, 2011; Honorable Mention, Laboratory and Methods Category: Sriram K, Lin GX, Jefferson AM, Roberts JR, Wirth O, Hayashi Y, Krajnak KM, Soukup JM, Ghio AJ, Reynolds SH, Castranova V, Munson AE, Antonini JM [2010]. Mitochondrial dysfunction and loss of Parkinson's disease-linked proteins contribute to neurotoxicity of manganese-containing welding fumes. *FASEB J* 24:4989–5002.
- Received the NIOSH Alice Hamilton Award, 2011; Best Paper, Biological Science Category: Sriram K, Lin GX, Jefferson AM, Roberts JR, Wirth O, Hayashi Y, Krajnak KM, Soukup JM, Ghio AJ, Reynolds SH, Castranova V, Munson AE, Antonini JM [2010]. Mitochondrial dysfunction and loss of Parkinson's disease-linked proteins contribute to neurotoxicity of manganese-containing welding fumes. *FASEB J* 24:4989–5002.
- Received the NIOSH Alice Hamilton Award, 2011; Honorable Mention, Best Paper, Biological Science Category: Leonard SS, Chen BT, Stone SG, Schwegler-Berry D, Kenyon AJ, Frazer, DG, Antonini JM [2010]. Comparison of stainless and mild steel welding fumes in generation of reactive oxygen species. *Particle Fibre Toxicol* 7:32.



## Publications and Abstracts

- Antonini JM, Taylor MD, Zimmer AT, Robert JR [2004]. Pulmonary responses to welding fumes: role of metal constituents. *J Toxicol Environ Health* 67:233–249.
- Antonini JM, Taylor MD, Millecchia L, Ebeling AR, Robert JR [2004]. Suppression in lung defense responses after bacterial infection in rats pretreated with different welding fumes. *Toxicol Appl Pharmacol* 200:206–218.
- Antonini JM, Leonard SS, Robert JR, Solano-Lopez C, Young S-H, Shi X, Taylor MD [2005]. Effect of stainless steel manual metal arc welding fume on free radical production, DNA damage, and apoptosis induction. *Mol Cell Biochem* 279:17–23.
- Antonini JM, Afshari AAA, Stone S, Chen B, Schwegler-Berry D, Fletcher WG, Goldsmith WT, Vandestouwe KH, McKinney W, Castranova, V, Frazer DG [2006]. Design, construction, and characterization of a novel robotic welding fume generation and inhalation exposure system for laboratory animals. *J Occup Environ Hyg* 3:194–203.
- Antonini JM, Santamaria A, Jenkins NT, Albini E, Lucchini R [2006]. Fate of manganese associated with the inhalation of welding fumes: potential neurological effects. *Neurotoxicology* 27:304–310.
- Antonini JM, O’Callaghan JP, Miller DB, Miller DB [2006]. Development of an animal model to study potential neurotoxic effects associated with welding fume inhalation. *Neurotoxicology* 27(5):745–751.
- Santamaria AB, Cushing CA, Antonini JM, Finley BL, Mowat FS [2007]. Potential neurological effects of manganese exposure during welding: a state-of-the-science analysis. *J Toxicol Environ Health* 10(6):417–465.
- Solano-Lopez C, Zeidler-Erdely PC, Hubbs AF, Reynolds SH, Roberts JR, Taylor MD, Young S-H, Castranova V, Antonini JM [2006]. Welding fume exposure and associated inflammatory and hyperplastic changes in the lungs of tumor susceptible A/J Mice. *Toxicol Pathol* 34(4):364–372.
- Antonini JM, Roberts JR [2007]. Comparison of lung injury and inflammation after repeated treatment with welding fumes collected from different welding processes. *Toxicologist* 91(1):216.
- Zeidler-Erdely PC, Young S-H, Roberts JR, Antonini JM [2007]. Acute lung inflammatory response following pharyngeal aspiration of stainless steel welding fume or soluble chromium in A/J and C57Bl/6J mice. *Toxicologist* 96(1):224.
- Santamaria AB, Cushing CA, Antonini JM, Finley BL, Mowat FS [2007]. Potential neurological effects of manganese exposure during welding: a state-of-the-science analysis. *J Toxicol Environ Health B* 10:417–465.
- Antonini JM, Stone S, Roberts JR, Chen B, Schwegler-Berry D, Afshari AA, Frazer DG [2007]. Effect of short-term stainless steel welding fume inhalation

- exposure on lung inflammation, injury, and defense responses in rats. *Toxicol Appl Pharmacol* 223:234–245.
- Antonini JM, Roberts JR [2007]. Comparison of lung injury and inflammation after repeated treatment with welding fumes collected from different welding processes. Society of Toxicology Annual Meeting, Charlotte, North Carolina, March 25–29. *Toxicologist* 96:103–104.
  - Antonini JM, Stone S, Roberts JR, Chen B, Frazer DG [2007]. Delayed inflammatory response after inhalation of stainless steel welding fume in rats. American Thoracic Society International Conference, San Francisco, California, May 18–23. *Am J Respir Crit Care Med* 175:A429.
  - Zeidler-Erdely PC, Kashon ML, Battelli LA, Young S-H, Erdely AD, Roberts JR, Reynolds SH, Antonini JM [2008]. Lung inflammation and tumor induction in lung tumor susceptible A/J and resistant C57BL/6J mice exposed to welding fume. *Part Fibre Toxicol* 5:12.
  - Antonini JM, Roberts JR, Sriram K, Benkovic SA, O’Callaghan JP, Miller DB [2008]. Extrapulmonary tissue distribution of metals following repeated lung exposures to welding fumes with different elemental profiles. Society of Toxicology Annual Meeting, Seattle, Washington, March 16–20. *Toxicologist* 102:226.
  - Antonini JM, Stone S, Roberts JR, Schwegler-Berry D, Moseley A, Donlin M, Cumpston J, Afshari A, Frazer DG [2008]. Pulmonary effects and tissue distribution of metals after inhalation of mild steel welding fume. American Thoracic Society International Conference, Toronto, Ontario, Canada, May 2008. *Am J Respir Crit Care Med* 177:A910.
  - Antonini JM, Schwegler-Berry D, Stone S, Chen TB, Zeidler-Erdely PC, Frazer DG, Roberts JR [2009]. Comparison of the persistence of deposited particles and the inflammatory potential of stainless steel versus mild steel welding fume in rat lungs after inhalation. Society of Toxicology Annual Meeting, Baltimore, Maryland, March 15. *Toxicologist* 108:329.
  - Zeidler-Erdely PC, Kashon ML, Li S, Antonini JM [2009]. Microarray analysis of the pulmonary effects of stainless and mild steel welding fumes in A/J and C57BL/6J mice. Society of Toxicology Annual Meeting, Baltimore, Maryland, March 15. *Toxicologist* 108:325.
  - Sriram K, Lin GX, Jefferson AM, Roberts JR, Stone S, Chen TB, Frazer DG, Soukup JM, Ghio AJ, Antonini JM [2009]. Dopaminergic neurotoxicity following exposure to manganese-containing welding fumes. Program No. 154.26. Society for Neuroscience Annual Meeting, Chicago, Illinois, October 20.
  - Sriram K, Lin GX, Jefferson AM, Wirth O, Hayashi Y, Roberts JR, Chapman RS, Krajnak KM, Antonini JM [2009]. Welding fume–related dopaminergic neurotoxicity. XVIII WFN World Congress on Parkinson’s Disease and Related Disorders, Miami, Florida, December 13. *Parkinsonism & Related Disorders* 15(2):S162.



- Antonini JM, Roberts JR, Stone S, Chen BT, Schwegler-Berry D, Frazer DG [2009]. Short-term inhalation exposure to mild steel welding fume had no effect on lung inflammation and injury but did alter defense responses to bacteria in rats. *Inhal Toxicol* 21:182–192.
- Keane M, Stone S, Chen BT, Slaven J, Schwegler-Berry D, Antonini JM [2009]. Hexavalent chromium content in stainless steel welding fumes is dependent on the welding process and shield gas type. *J Environ Monitoring* 11:418–424.
- Antonini JM, Sriram K, Benkovic SA, Roberts JR, Stone S, Chen BT, Schwegler-Berry D, Jefferson AM, Billig BK, Felton CM, Hammer MA, Ma F, Frazer DG, O'Callaghan JP, Miller DB [2009]. Mild steel welding fume causes manganese accumulation and subtle neuroinflammatory changes but not overt neuronal damage in discrete brain regions of rats after short-term inhalation exposure. *Neurotoxicology* 30:915–925.
- Erdely A, Zeidler-Erdely PC, Liston A, Salmen-Muniz R, Hulderman T, Antonini JM, Simeonova PP [2010]. Acute systemic inflammation to welding fume: comparison of various types. Society of Toxicology Annual Meeting, Salt Lake City, Utah, March 15. *Toxicologist* 114:463.
- Antonini JM, Chen BT, Stone S, Roberts JR, Schwegler-Berry D, Chapman R, Moseley A, Cumpston JL, Leonard H, Frazer DG, Keane M, Sriram K [2010]. Alterations in welding process parameters change particle characteristics and influence lung responses. American Thoracic Society International Conference, New Orleans, LA, May 14. *Am J Respir Crit Care Med* 181:A1746.
- Erdely A, Hulderman T, Zeidler-Erdely PC, Liston A, Salmen-Muniz R, Stone S, Chen BT, Frazer DG, Antonini JM, Simeonova PP [2010]. Effects of inhalation of gas metal arc–stainless steel welding fume on systemic inflammation and atherosclerosis. American Thoracic Society International Conference, New Orleans, LA, May 14. *Am J Respir Crit Care Med* 181:A1754.
- Zeidler-Erdely PC, Li S, Kashon ML, Antonini JM [2010]. Response of the mouse lung transcriptome to welding fume: effects of stainless and mild steel fumes on lung gene expression in A/J and C57 BL/6J mice. *Resp Res* 11:70.
- Sriram K, Lin, GX, Jefferson AM, Roberts JR, Chapman RS, Soukup JM, Ghio AJ, Chen BT, Antonini JM [2010]. Dopaminergic neurotoxicity following pulmonary exposure to manganese-containing welding fumes. *Arch Toxicol* 84:521–540.
- Antonini JM, Roberts JR, Chapman R, Soukup JM, Ghio AJ, Sriram K [2010]. Pulmonary toxicity and extrapulmonary tissue distribution of metals after repeated exposure to different welding fumes. *Inhal Toxicol* 22:805–816.
- Sriram K, Lin GX, Jefferson AM, Roberts JR, Wirth O, Hayashi Y, Krajnak KM, Soukup JM, Ghio AJ, Reynolds SH, Castranova V, Munson AE, Antonini JM [2010]. Mitochondrial dysfunction and loss of Parkinson's disease-linked proteins contribute to neurotoxicity of manganese-containing welding fumes. *FASEB J* 24:4989–5002.

- Leonard SS, Chen BT, Stone SG, Schwegler-Berry D, Kenyon AJ, Frazer, DG, Antonini JM [2010]. Comparison of stainless and mild steel welding fumes in generation of reactive oxygen species. *Particle Fibre Toxicol* 7:32.
- Antonini JM, Roberts JR, Stone S, Chen BT, Schwegler-Berry D, Chapman R, Zeidler-Erdely PC, Andrews RN, Frazer DG [2011]. Persistence of deposited metals in the lungs after stainless steel and mild steel welding fume inhalation in rats. *Arch Toxicol* 85:487–498.
- Antonini JM, Keane M, Chen BT, Stone S, Roberts JR, Schwegler-Berry D, Andrews RN, Frazer DG, Sriram K [2011]. Alterations in welding process voltage affect the generation of ultrafine particles, fume composition, and pulmonary toxicity. *Nanotoxicology* 5:700–710.

### Invited Presentations

- Antonini J [2008]. Manganese exposure during welding. Institute of Occupational and Environmental Health, West Virginia University, Morgantown, West Virginia, Occupational Medicine Grand Rounds Seminar, March 4.
- Antonini J [2008]. Health effects of welding. American Industrial Hygiene Association conference and exposition AIHce 2008, Minneapolis, Minnesota, May 31–June 5.
- Antonini J [2009]. Hexavalent chromium carcinogenesis, welding exposure assessments, and epidemiology studies. American Industrial Hygiene Association Annual Meeting: AIHce 2009, Toronto, Ontario, May 30–June 4.
- Antonini J [2010]. Neurological responses after exposure to inhaled metal particles 49th Society of Toxicology Annual Meeting, Salt Lake City, Utah, March 15.
- Antonini J [2011]. Health effects of welders. American Industrial Hygiene Association Annual Meeting: AIHce 2011, Portland, Oregon, May 15–19.



## Project 15: Welding Fumes and Cardiovascular Dysfunction

**Principle Investigator:** Hong Kan

**Project Duration:** FY 2010–2013

**Critical Topic Areas:** Toxicology and internal dose

### Accomplishments and Research Findings

Our laboratory utilized novel animal and in vitro models to assess the short- and long-term effects of pulmonary exposure to nano-sized particles produced from industrial and occupational settings.

Pulmonary exposure to ultrafine titanium dioxide (UFTiO<sub>2</sub>) or intratracheal instillation of welding fumes can cause either biological or functional changes in rat hearts, which include the following:

- Alteration in cytokine gene expressions in the heart (welding fumes).
- Change in phosphorylation status of cardiac regulatory proteins (UFTiO<sub>2</sub> and welding fumes).
- More prone to heart arrhythmias under stress condition (UFTiO<sub>2</sub> and welding fumes).
- Reduction in contractile function of the heart (welding fumes).
- Increase in synthesis of neurotransmitter substance P in nodose ganglia, which is involved in the integration and control of lung and heart function (UFTiO<sub>2</sub>).

UFTiO<sub>2</sub>- and welding fume-induced biological and functional changes in the heart that we observed in our study are often associated with heart failure or other cardiovascular dysfunctions. Our findings suggest that workers exposed to nanoparticles might have a higher risk of developing cardiovascular disease.

### Publications and Abstracts

- Hong K [2011]. Nanoparticle inhalation enhances cardiac protein phosphorylation and neurotransmitter synthesis in the nodose ganglia of rats (Abstract submitted to SOT 2012).



## Project 16: Potential Aneuploidy Following Exposure to Carbon Nanotubes

**Principal Investigator:** Linda Sargent, PhD

**Project Duration:** FY 2007–2011

**Critical Topic Area:** Toxicology and internal dose

### Accomplishments and Research Findings

Primary and immortalized human small airway epithelial cells were cultured and then exposed to single-walled carbon nanotubes (SWCNTs) or a positive control vanadium pentoxide to investigate the potential of CNTs to induce genetic damage in normal lung cells. The nanotubes had an average diameter of 1.1 nanometer and a length of 100–1,000 nanometers. Cellular tubulin, mitotic spindle integrity, and centriole number were determined by immunofluorescence for beta-tubulin and centrin and photographed with fluorescent and confocal laser scanning microscopy. The chromosome number was examined by fluorescent in situ hybridization (FISH).

- Binucleate cells, large polyploid appearing nuclei, bundled tubulin, and fragmented centrosomes were observed following 24 hours of exposure to either SWCNTs or vanadium pentoxide.
- The SWCNT-treated cells were further examined by FISH, with large genomic probes labeled with fluorescent tags. FISH showed that the large nuclei were polyploid. The number of chromosomes per cell was not normal (aneuploid). Mitotic spindles were found to have multiple poles and many cells had anaphase bridges with fragmenting chromatin. Using different interference confocal microscopy (DIC), SWCNTs were observed to be inside the cells. DIC combined with fluorescent confocal laser imaging showed that many of the cells had SWCNTs in the nucleus and within the cellular and mitotic tubulin. Some of the binucleate cells appeared to be connected by SWCNTs. CNTs in the mitotic spindle appear to distort the mitotic spindle apparatus. This damage was seen even at the lowest dose (24  $\mu\text{g}/\text{cm}^3$ ).
- In vitro genotoxicity of SWCNTs:
  - Exposure to multi-walled carbon nanotubes (MWCNTs) and SWCNTs has been shown to result in hypertrophied epithelial cells, macrophages without nuclei, and mutations in K-ras, indicating potential genotoxicity.

A study by Sargent et al. in 2009 showed that SWCNT exposure resulted in fragmenting of the mitotic spindle pole (centrosome) as well as gross errors in chromosome number. The study further demonstrated a close association of SWCNTs with the centrosome, the DNA, and the microtubules of the mitotic spindle. The nanosized particles appeared to be incorporated into the mitotic spindle, resulting in a dramatic



disruption of the spindle apparatus and aneuploidy. This research proposed a new mechanism of genotoxicity.

- Received the 2010 Charles C. Shepard Science Award nomination for outstanding scientific paper, *Induction of Aneuploidy by Single-Walled Carbon Nanotubes*.
- In vitro dose response and time course:
  - Demonstrated that SWCNT exposure results in multipolar mitotic spindles at realistic occupational exposure levels. The nanotubes were incorporated into the DNA, the microtubules, and the centrosome. Cell cycle analysis demonstrated a block in the G2 phase of the cell cycle. Analysis of the chromosome changes (either loss or gain of chromosome 1 or 4) demonstrated that the aneuploidy was randomly distributed between alterations of chromosome 1 or chromosome 4. The aneuploid population was attributed to both losses and gains of chromosome 1 and 4. The SWCNT-treated cells exhibit a statistically significant higher percentage of the G2/M population than in the PBS-treated control cells, indicating a G2 block in the cell cycle.
- Comparison of in vitro genotoxicity of MWCNTs and SWCNTs:
  - The MWCNT exposure results in predominantly monopolar mitotic spindles. The MWCNTs associate with the microtubules and the DNA and fragment the centrosomes similar to SWCNTs. By contrast, however, the MWCNT-exposed, fragmented centrosomes cluster to organize a single pole. These data indicate that both nanotubes associate with mitotic structures; however, the difference in the spindle morphology following exposure suggests a difference in the inhibition of the cell motors.

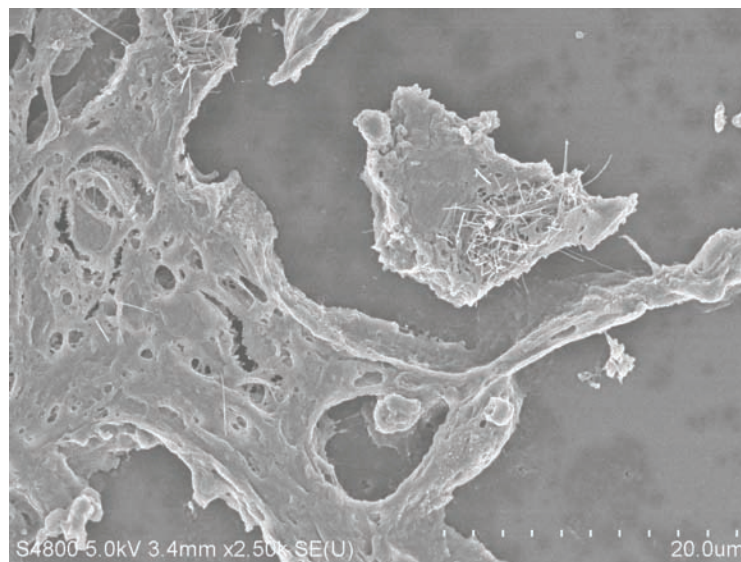

Multi-walled carbon nanotubes in cells and tissue

- In vivo dose response of genotoxicity:
  - BALB/c X C57Bl/6 hybrid mice have been bred to BALB/c mice for 5 generations. The GFP-centrin BALB-c mice are intermediate in their proliferative response, which is a distinct advantage for cytogenetic studies requiring proliferating cells.

GFP-centrin/Balb/c mice have been exposed to SWCNTs (40 mg/mouse) and the positive control vanadium pentoxide. The lungs have been perfused, the Type II cells have been separated and cultured, and the proliferating cells have been prepared for analysis of the mitotic spindle and the chromosome number. The advantage of the GFP-centrin transgenic mouse is that the centrosome damage can be seen without staining. It is a rapid in vivo test of the integrity of the centrosome.

## Publications and Abstracts

- Sargent L, Shvedova AA, Hubbs AF, Lowry DT, Kashon ML, Murray AR, Kisin E, Benkovic S, Miller D, McKinstry KA, Reynolds SH [2009]. Induction of aneuploidy by single walled carbon nanotubes [abstract]. *Toxicologist* 108(1):411, A1979.
- Sargent LM, Shvedova AA, Hubbs AF, Kashon ML, Salisbury JL, Lowry DT, Murray A, Kisin E, Friend S, Benkovic S, McKinstry KA, Battelli LA, Reynolds S [2009]. Induction of aneuploidy by single walled carbon nanotubes. *Environ Mol Mutagen* 50(8):708–717.
- Dinu CZ, Mohanraj B, Schiele NR, Sargent LM, Corr DT, Chrisey DB [2010]. Real-time detection of carbon nanotube cytotoxicity using electric cell-impedance sensing [abstract]. Presented (by collaborator) at the European Materials Research Society 2010 Meeting on Functional Biointerfaces in Strasbourg, France, June 7–11.
- Sargent LM, Hubbs AF, Shvedova AA, Kashon ML, Salisbury JL, Lowry DT, Murray A, Kisin E, Benkovic S, McKinstry KA, Reynolds SH [2010]. Induction of mitotic spindle aberrations by occupationally relevant doses of single walled carbon nanotubes [abstract]. *Toxicologist* 114(1):170, A799.
- Sargent L, Reynolds S, Castranova V [2010]. Potential pulmonary effects of engineered carbon nanotubes: In vitro genotoxic effects. *Nanotoxicology* 4:396–408.
- Hubbs AF, Mercer R, Benkovic S, Harkema J, Sriram K, Schwegler-Berry DE, Gorravanahally M, Nurkiewicz T, Castranova V, Sargent LM [2011]. Nanotoxicology, a pathologist's perspective. *Toxicol Pathol* 39(2):301–324.
- Kisin E, Murray AR, Sargent L, Lowry DT, Siegrist KJ, Chirila M, Schwegler-Berry DE, Leonard SS, Castranova V, Fadeel B, Kagan VE, Shvedova AA [2011]. Comparative genotoxicity of fibrous particles: carbon nanofibers, single-walled carbon nanotubes and asbestos [abstract]. *Toxicologist* 120(2):2.



- Kisin ER, Murray AR, Sargent L, Lowry D, Chirila M, Siegrist KJ, Schewegler-Berry D, Leonard S, Castranova V, Fadeel B, Kagan VE and Shvedova AA [2011]. Genotoxicity of carbon nanofibers: are they potentially more or less dangerous than carbon nanotubes or asbestos? *Toxicol Appl Pharmacol* 252(April 1):1–10.
- Sargent LM, Reynolds SH, Benkovic SA, Lowry DT, Kashon ML, Hubbs AF, Mastovich J, Siegrist KJ, Chrisey DB, Dinu DZ [2011]. Understanding carbon nanotube genotoxicity. *Toxicologist* 120(2):11–12.
- Archer-Hartmann SA, Sargent LM, Lowry D, Holland LA [2011]. Microscale enzymatic and lectin classification of glycans with phospholipid assisted capillary electrophoresis separations. *Analytical Chem* 83(7):2740–2747.
- Sargent LM, Young S-H, Hubbs AF, Benkovic SA, Shvedova AA, Salisbury JL, Kashon ML, Lowry DT, Murray AR, Kisin ER, Mckinstry KT, Batelli L, Steven H Reynolds [2011]. Multi-polar mitotic spindle disruption and aneuploidy at occupationally relevant doses of single-walled-carbon nanotubes. *Mutation Res* (in press).

### Invited Presentations

- Sargent L [2008]. Genetic impact of carbon nanotubes and chemically specific genetic changes in lung adenocarcinoma. Naval Health Research Center, Detachment, Environmental Health Effects Laboratory, Wright-Patterson AFB, Dayton, Ohio, May 28.
- Sargent L [2008]. Genetic damage following carbon nanotube exposure. Mary Babb Randolph Cancer Center–National Institute of Occupational Safety and Health Scientific Retreat on Cancer, February 12.
- Sargent LM [2009]. Induction of aneuploidy by single walled carbon nanotubes. Society of Toxicology Annual Meeting, Baltimore, Maryland, March 15–19.
- Dinu CZ, Lowry DT, Chrisey DB, Sargent LM [2010]. Understanding nanomaterial cytotoxicity through functional biohybrids [abstract]. European Materials Research Society 2010 Meeting on Functional Biointerfaces, Strasbourg, France, June 7–11.
- Dinu CZ, Mohanraj B, Schiele NR, Sargent L, Corr DT, Chrisey DB [2010]. Real-time detection of carbon nanotube cytotoxicity using electric cell-impedance sensing [abstract]. Presented (by collaborator) at the European Materials Research Society 2010 Meeting on Functional Biointerfaces, Strasbourg, France, June 7–11.
- Sargent LM, Dinu C, Hubbs AF, Benkovic S, Shvedova AA, Lowry DT, Kashon ML, Salisbury J, Murray A, Kisin E, Reynolds S [2010]. Induction of mitotic spindle aberrations by occupationally relevant doses of single walled carbon nanotubes and multi-walled carbon nanotubes. NTRC 2010 Update, Wheeling, West Virginia, April 19–21.

- Sargent LM, Dinu C, Hubbs AF, Benkovic S, Shvedova AA, Lowry DT, Kashon ML, Salisbury J, Murray A, Kisin E, Reynolds S [2010]. Induction of mitotic spindle aberrations by occupationally relevant doses of single walled carbon nanotubes and multiwalled carbon nanotubes [abstract]. NTRC Update, Wheeling, West Virginia, April 19–21.
- Dinu Z, Lowry DT, Chrisey DB, Sargent L [2010]. Understanding nanomaterial cytotoxicity through functional biohybrids [abstract]. Presented (by collaborator) at the European Materials Research Society 2010 Meeting on Functional Biointerfaces. Strasbourg, France, June 7–11.
- Dinu C, Reynolds S, Lowry DT, Kashon ML, Chrisey D, Sargent L [2010]. Understanding carbon nanotube genotoxicity [abstract]. Presentation at European Materials Research Society 2010 Meeting on Functional Biointerfaces. Strasbourg, France, June 7–11.



## Project 17: Nanoparticle Properties and Mechanisms Causing Lung Fibrosis

**Principle Investigator:** Liying Wang Rojanasakul, PhD

**Project Duration:** FY 2008–2012

**Critical Topic Areas:** Toxicology and internal dose

### Accomplishments and Research Findings

- Dispersed single-walled carbon nanotubes (SWCNTs) exhibited a biphasic effect on cells, inducing proliferation at low doses and causing toxicity at high doses, whereas non-dispersed SWCNTs had no significant effects.
- Dispersed SWCNTs upregulated collagen expression from cultured lung fibroblasts and lung tissue in a mouse model, whereas non-dispersed SWCNTs had a lesser effect. The data supported our proposed hypothesis that the dispersion status of CNTs is a key factor in determining their bioactivities. Direct stimulation of fibroblasts by dispersed SWCNTs translocated into the interstitium could be a novel mechanism of unique nanoparticle-induced lung fibrosis.
- Survanta, a natural lung surfactant, effectively disperses SWCNT agglomerate into a small structure that is similar to aerosolized SWCNTs in size. In addition, at the concentration of Survanta used for the dispersion, it showed no toxic or mask effect, which makes it an almost ideal dispersion agent for nanoparticle suspension.
- SWCNTs or MWCNTs induce well-known fibrogenic mediators from cultured human lung cells, i.e., transformation growth factor (TGF- $\beta$ 1) and matrix metalloproteinase 9 (MMP 9).
- These data show that in vitro cell culture models using human lung fibroblasts and epithelial cells may be used as rapid screening tools for fibrogenicity and cytotoxicity testing of nanomaterials.

### Publications and Abstracts

- Wang L, Castranova V, Mercer RR, Wu N, Li T, Li S, Hall J, Li M, Rojanasakul Y [2009]. Nanoparticle dispersion method using natural lung surfactant. *Toxicologist* 108:A2198.
- Mercer RR, Scabilloni F, Wang L, Battelli L, Castranova V [2009]. Use of labeled single walled carbon nanotubes to study translocation from the lungs. *Toxicologist* 108:A2192.



- Wang L, Castranova V, Mishra A, Chen B, Mercer R.R, Schwegler-Berry D, Rojanasakul Y [2010]. Dispersion of single-walled carbon nanotubes by a natural lung surfactant for pulmonary in vitro and in vivo toxicity studies. *Particle Fibre Toxicol* 7:31.
- Mercer RR, Hubbs A, Scabilloni J, Wang L, Battelli L, Schwegler-Berry D, Castranova V, Porter P [2010]. Distribution and persistence of pleural penetrations by multi-walled carbon nanotubes. *Particle Fibre Toxicol* 7:28.
- Wang L, Mercer RR, Rojanasakul Y, Qiu A, Lu Y, Scabilloni JF, Wu N, Castranova V [2010]. Direct fibrogenic effects of dispersed single-walled carbon nanotubes on human lung fibroblasts. *J Toxicol Environ Health A* 73:410–422.
- Mercer RR, Hubbs AF, Scabilloni JF, Wang L Castranova V, Porter D [2010]. Distribution and persistence of pleural penetrations by multi-walled carbon nanotubes. *Am J Respir Crit Care Med* 181:A3102.
- Lu Y, Azad N, Wang L, Iyer AKV, Castranova V, Jiang BH, Rojanasakul Y [2010]. Phosphatidylinositol-3-kinase/AKT regulates fibrogenesis in human lung fibroblasts. *Am J Respir Cell Mol Biol* 42(4):432–441 (Epub 2009 Jun 11).
- Wang L, Mishra A, Castranova V, Schwegler-Berry D, Chen B, Mercer R, Rojanasakul Y [2010]. Dispersion status of single walled carbon nanotubes is a key determinant of their biological activities. *Toxicologist* 114:1, A797.
- Mishra A, Castranova V, Rojanasakul Y, Hall J, Wang L [2010]. Pulmonary toxicity assessment of multi-wall carbon nanotubes in vitro. *Toxicologist* 114:1, A798.
- Wang L, Luanpitpong S, Castranova V, Lu Y, Pongrakhananon V, Rojanasakul Y [2011]. Carbon nanotubes induce malignant transformation and tumorigenesis of human lung epithelial cells. *Nano Letters* 13;11(7):2796–2803.
- Song Y, Li X, Wang L, Rojanasakul Y, Castranova V, Li H, Ma J [2011]. Nanomaterials in humans: identification, characteristics, and potential damage. *Toxicol Pathol* 39:841.
- Yao S, Wang L, Chen Z, Xu Y, Bai Y, Chen G, Zhang X, Zhang C, Yu Y, Shen F, Yuan J, Chen J, He Q [2011]. Fas/FasL pathway-mediated alveolar macrophage apoptosis involved in human silicosis. *Apoptosis* 16:1195–1204.
- Iyer A, Azad N, Talbott S, Stehlik C, Lu B, Wang L, Rojanasakul Y [2011]. Antioxidant C- flip regulates fas ligand-induced NF-kB activation in a PI3K/AKT-dependent manner. *J Immunol* 15;187(6):3256–3266.
- Mercer RR, Hubbs A, Scabilloni J, Wang L, Battelli L, Castranova V, Porter D [2011]. Pulmonary fibrotic response to aspiration of multi-walled carbon nanotubes. *Particle Fibre Toxicol* 8:21.
- Pongrakhananon V, Lu Y, Wang L, Stueckle T, Luanpitpong S, Rojanasakul Y [2011]. Carbon nanotubes induce apoptosis resistance through flice-inhibitory protein. *Toxicologist* 253:1187.





- Wang L, Lu Y, Castranova V, Luanpitpong S, Pongrakhananon V, Rojanasakul Y [2011]. Potential carcinogenicity of carbon nanotubes. *Toxicologist* 253:1188.
- Derk R, Mishra A, Stueckle T, Rojanasakul Y, Castranova V, Wang L [2011]. Elucidation of factors determining carbon nanotubes' ability to penetrate alveolar epithelial barrier and interact with lung fibroblasts in vitro. *Toxicologist* 253:1181.
- Mercer RR, Hubbs AF, Scabilloni J, Wang L, Battelli L, Castranova V, Porter D [2011]. Pulmonary fibrotic response to sub-chronic multi-walled carbon nanotube exposure. *Toxicologist* 253:56.
- Stueckle T, Mishra A, Derk R, Rojanasakul Y, Castranova V, Wang L [2011]. In vitro assessment of potential tumorigenicity of chronic SWCNT and MWCNT exposure to lung epithelium. *Toxicologist* 253:1182.
- Mishra A, Rojanasakul Y, Castranova V, Mercer RR, Wang L [2011]. Assessment of fibrogenic biomarkers induced by multi wall carbon nanotubes. *Toxicologist* 253:1183.

### Invited Presentations

- Wang L, Chanvorachote P, Lu Y, Talbott S, Rojanasakul Y [2009]. Nitric oxide regulates lung carcinoma cell anoikis through s-nitrosylation and inhibition of proteasomal degradation of caveolin-1. The 4th International Conference on Oxidative/Nitrosative Stress and Disease, New York, New York, October 30.
- Mishra A, Hall J, Wang L [2009]. Assessment of pulmonary toxicity of dispersed carbon nanotubes. WVU-Van-Liere Convocation and Research Day, Morgantown, West Virginia, April 27.
- Wang L, Castranova V, Mercer RR, Wu N, Li T, Li S, Hall J, Li M, Rojanasakul Y [2009]. Nanoparticle dispersion method using natural lung surfactant. Society of Toxicology Annual Meeting, Baltimore, MD, March 17.
- Mishra A, Rojanasakul Y, Wang L [2009]. Evaluation of unique pulmonary toxicity of surfactant-dispersed carbon nanotubes using in-vitro methods. WVNano Research Symposium, Morgantown, West Virginia, May 11.
- Wang L, Castranova V, Lu Y, Rojanasakul Y [2010]. Development of an in vitro model with predictive potential for carcinogenicity of carbon nanotubes. Nanotoxicology International Conference, Scotland, UK, June 2–4.
- Mercer RR, Hubbs A, Scabilloni JF, Wang L, Castranova V, Porter D [2010]. Distribution and persistence of pleural penetrations by multi-walled carbon nanotubes. American Thoracic Society, New Orleans, LA, May 14–19.
- Wang L [2010]. Physicochemical properties of carbon nanotubes affecting their bio-activities. Inaugural School of Pharmacy Research Day, West Virginia University, Morgantown, West Virginia, February 19.

- Wang L, Rojanasakul Y, Mishra A, Chen B, Schwegler-Berry D, Mercer RR and Castranova V [2010]. Dispersion status of single walled carbon nanotubes is a key determinant of their biological activities. NIOSH NTRC 2010 Update, Wheeling, West Virginia, April 20.
- Wang L, Rojanasakul Y, Castranova V [2010]. Properties of carbon nanotubes influencing their bio-activities. NIOSH Intramural Science Conference, Salt Fork, Ohio, August 10.
- Stueckle T, Wang L, Mishra A, Castranova V, Rojanasakul Y [2010]. Properties and dispersion status of single and multi walled carbon nanotubes influence their bioactivities in rapid in vitro and in vivo assays. Clemson Meeting, Atlanta, August 23.
- Wang L, Mishra A, Castranova V, Schwegler-Berry D, Chen B, Mercer R, Rojanasakul Y [2010]. Dispersion status of single walled carbon nanotubes is a key determinant of their biological activities. Society of Toxicology Annual Meeting, Salt Lake City, Utah, March 9.
- Mishra A, Castranova V, Rojanasakul Y, Hall J, Wang L [2010]. Pulmonary toxicity assessment of multi-wall carbon nanotubes in vitro. Society of Toxicology Annual Meeting, Salt Lake City, Utah, March 9.
- Iyer A, Azad N, Wang L, Rojanasakul Y [2010]. Tumorigenic potential of single-walled carbon nanotubes. Towards Personalized Cancer Medicine: New York Academic Science Conference, Barcelona, Spain, May 20.
- Mishra A, Castranova V, Rojanasakul Y, Qiu L, Wang L [2010]. Assessment of fibrogenic potential of carbon nanotubes in vitro. Van-Liere Convocation and Research Day, West Virginia University, Morgantown, West Virginia, April 21.
- Liying W, Rojanasakul Y [2010]. Direct fibrogenic effects of single-walled carbon nanotubes on human lung fibroblasts. WVNano Initiative, West Virginia University, Morgantown, West Virginia, April 5.
- Liying W, Rojanasakul Y [2010]. Physicochemical Properties of Carbon Nanotubes Affecting their Bio-activities. Inaugural School of Pharmacy Research Day, West Virginia University. Morgantown, West Virginia. February 19.
- Wang L [2011]. Potential carcinogenicity of carbon nanotubes. Beijing University, Beijing, China, September 14.
- Wang L [2011]. Micron sized particle and nano-sized particle (carbon nanotubes): different ways to cause lung fibrosis. Hebei United University, Hebei, China, September 13.
- Wang L [2011]. General introduction of carbon nanotubes and nano-toxicology. Harbin Medical University, 4th affiliated hospital. Harbin, China, August 31.
- Wang L, Mishra A, Stueckle T, Derk R, Rojanasakul Y, Castranova V [2011]. Development of in vitro vs. in vivo models to evaluate fibrogenic and carcinogenic potential of carbon nanotubes. NORA Symposium, Cincinnati, Ohio, July 12.



## Project 18: Pulmonary Toxicity of Carbon Nanotube Particles

**Principal Investigator:** Anna Shvedova, PhD

**Project Duration:** FY 2004–2008

**Critical Topic Area:** Toxicology and internal dose

### Accomplishments and Research Findings

- Found that low levels of antioxidants in vitamin E–deficient mice were associated with a higher sensitivity to single-walled carbon nanotube (SWCNT)- induced acute inflammation, released LDH, total protein content, levels of proinflammatory cytokines, and enhanced profibrotic responses and collagen deposition.
- Found that exposure to SWCNTs markedly shifted the ratio of cleaved to full-length extracellular superoxide dismutase (EC-SOD) in the lungs. Found no differences in the EC-SOD responses to SWCNT-induced oxidative stress between vitamin E–deficient and vitamin E–sufficient animals.
- Sequential exposure to carbon nanotubes and bacteria was observed to enhance pulmonary inflammation and infectivity.
- Decreased bacterial clearance in SWCNT-pre-exposed mice was associated with decreased phagocytosis of bacteria by macrophages and a decrease in nitric oxide production by these phagocytes.
- Failure of SWCNT-exposed mice to clear lysteria led to a continued elevation in nearly all major chemokines and acute-phase cytokines into the later course of infection.
- An increased accumulation of neutrophils and decreased fibrosis were observed in the lungs of NADPH oxidase–deficient C57BL/6 mice exposed to CNTs. This corresponded to elevated levels of apoptotic cells in the lungs, production of proinflammatory cytokines, decreased production of the anti-inflammatory and profibrotic cytokine TGF-beta, and reduced levels of collagen deposition.
- Found NADPH oxidase to be an important regulator of the transition from acute inflammation to the chronic fibrotic stage in response to SWCNTs.
- Developed a generation system that aerosolizes SWCNTs for an inhalation study. The resulting aerosol was size-separated with a settling chamber and two cyclones to produce a respirable aerosol.
- The mass output efficiency of the entire system for producing a respirable aerosol from bulk material was estimated to be about 10%.

- Completed inhalation study of SWCNT in C57BL/6 mice ([http://www.ncbi.nlm.nih.gov/pubmed/18658273?ordinalpos=2&itool=EntrezSystem2.PEntrez.Pubmed.Pubmed\\_ResultsPanel.Pubmed\\_DefaultReportPanel.Pubmed\\_RVDocSum](http://www.ncbi.nlm.nih.gov/pubmed/18658273?ordinalpos=2&itool=EntrezSystem2.PEntrez.Pubmed.Pubmed_ResultsPanel.Pubmed_DefaultReportPanel.Pubmed_RVDocSum)).
- The inhalation of nonpurified SWCNTs (iron content of 17.7% by weight) at 5 mg/m<sup>3</sup> 5 hr/day for 4 days was compared with pharyngeal aspiration of varying doses (5–20 µg per mouse) of the same SWCNTs.
- The chain of pathological events in both exposure routes was realized through synergized interactions of early inflammatory response and oxidative stress, culminating in the development of multifocal granulomatous pneumonia and interstitial fibrosis.
- SWCNT inhalation was more effective than aspiration in causing inflammatory response, oxidative stress, collagen deposition, and fibrosis as well as mutations of K-ras gene locus in the lung of C57BL/6 mice.

## Publications and Abstracts

- Shvedova AA, Castranova, V, Kisin E, Schwegler-Berry D, Murray AR, Gandelsman VZ, Maynard A, Baron P [2003]. Exposure to carbon nanotube material: assessment of nanotube cytotoxicity using human keratinocyte cells. *J Toxicol Environ Health 66(Part A):1901–1918*.
- Shvedova AA, Kisin ER, Murray AR, Schwegler-Berry D, Gandelsman VZ, Baron P, Maynard A, Gunther MR, Castranova V [2004]. Exposure of human bronchial epithelial cells to carbon nanotubes caused oxidative stress and cytotoxicity. *Proceedings of the Society for Free Radical Research Meeting, European Section, Ioannina, Greece, June 26–29, 2003, pp. 91–103*.
- Shvedova AA, Kisin E, Murray AR, Gorelik O, Arepalli S, Gandelsman VZ, Mercer B, Hubbs A, Kagan VE, Castranova V [2004]. Oxidative stress and pulmonary toxicity of carbon nanotubes. *Free Radical Biol Med 37(1)*.
- Shvedova AA, Kisin E, Murray A, Maynard A, Baron P, Gunther M, Keshava N, Schwegler-Berry D, Gandelsman V, Gorelik O, Aperalli S, Kagan V, Castranova V [2004]. Assessment of carbon nanotube cytotoxicity using human cells and animal models. *Proceedings of The Toxicology Forum's 29th Toxicology Annual Winter Meeting, Washington, DC, February 2–4*.
- Shvedova A, Kisin E, Mercer R, Murray A, Johnson VJ, Potapovich A, Tyurina Y, Gorelic O, Arepalli S, Schwegler-Berry D, Antonini J, Evans DE, Ku B-K, Ramsey D, Maynard A, Kagan VE, Castranova V, Baron P [2005]. Unusual inflammatory and fibrogenic pulmonary responses to single walled carbon nanotubes in mice. *Am J Physiol Lung Cell Mol Physiol 289:L698–L708*.
- Heck DE, Kagan VE, Shvedova AA, Laskin JD [2005]. An epigrammatic (abridged) recounting of the myriad tales of astonishing deeds and dire consequences pertaining to nitric oxide and reactive oxygen species in



mitochondria with an ancillary missive concerning origin of apoptosis. *Toxicology* 208(2):259–271.

- Kagan VE, Bayir H, Shvedova AA [2005]. Nanomedicine and nanotoxicology: two sides of the same coin. *J Nanomed Nanotechnol Biol Med* 1(4):313–316.
- Kisin E, Murray AR, Johnson V, Gorelik O, Arepalli S, Gandelsman VZ, Hubbs AF, Mercer RR, Baron P, Kagan VE, Castranova V, Shvedova AA [2005]. Pulmonary toxicity of carbon nanotubes. *Toxicologist* 84:A1041.
- Mercer RR, Scabilloni J, Kisin E, Gorelik O, Arepalli S, Murray AR, Castranova V, Shvedova AA [2005]. Responses of lung parenchyma to carbon nanotubes. *Toxicologist* 84:A1042.
- Shvedova AA, Potapovich AL, Osipov AN, Tyurina YY, Kisin E, Schwegler-Berry D, Mercer RR, Castranova V, Kagan VE [2006]. Oxidative interactions of single walled carbon nanotubes with RAW 264.7 macrophages: role of iron. *Toxicology* 90(1):A1557.
- Kisin E, Murray AR, Castranova V, Kagan VE, Shvedova AA [2006]. Single-wall carbon nanotubes induce oxidative stress, acute inflammation, and progressive pulmonary fibrosis. *Toxicology* 90(1):A1556.
- Kagan VE, Potapovich AN, Osipov YY, Tyurina ER, Kisin E, Schwegler-Berry D, Mercer R, Castranova V, Shvedova AA [2006]. Direct and indirect effects of single-walled carbon nanotubes on RAW 264.7 macrophages: role in iron. *Toxicol Lett* 165:88–100.
- Feng WH, Tyurina YY, Bayir H, Shvedova AA, Kagan VE [2007]. Phosphatidylserine enhances recognition and uptake of single-walled carbon nanotubes by rat microglial cells. *Toxicologist* 96(1):289.
- Kagan V, Tyurina YY, Konduru N, Basova L, Stolz D, Kisin E, Murray A, Fadeel B, Shvedova A [2007]. Targeted delivery of phosphatidylserine-coated single-walled carbon nanotubes to macrophages. *Toxicologist* 96(1):233.
- Shvedova AA, Kisin ER, Murray A, Gorelik O, Arepalli S, Castranova V, Young S-H, Gao F, Tyurina YY, Oury T, Kagan VE [2007]. Vitamin E deficiency enhances pulmonary inflammatory response and oxidative stress induced by single-walled carbon nanotubes in C57B6/L mice. *Toxicologist* 96(1):37.
- Shvedova AA, Sager T, Murray AR, Kisin E, Porter DW, Leonard SS, Schwegler-Berry D, Robinson VA, Castranova V [2007]. Critical issues in the evaluation of possible adverse pulmonary effects from airborne nanoparticles. In: Monteiro-Riviere NA, Tran CL, eds. *Nanotoxicology: characterization, dosing, and health effects*. New York: Informa Healthcare USA, Inc.
- Kagan VE, Rao KMK, Kisin ER, Young S-H, Meighan T, Murray AR, Tyurina YY, Castranova V, Shvedova AA [2007]. Pulmonary effects of single-walled carbon nanotubes: inflammatory response, oxidative stress/signaling, and recognition by macrophages. In: Simeonova PP, Opopol N, Luster MI, eds.

- Nanotechnology: toxicological issues and environmental safety, NATO security through science series book, New York: Springer-Verlag, pp. 65–75.
- Shvedova AA, Kisin ER, Murray AR, Gorelik O, Arepalli S, Castranova V, Young SH, Gao F, Tyurina YY, Oury TD, Kagan VE [2007]. Vitamin-E deficiency enhances pulmonary inflammatory response and oxidative stress induced by single-walled carbon nanotubes in C57BL/6 mice. *Toxicol Appl Pharmacol* 221(3):339–348.
  - Fadeel B, Kagan V, Krug H, Shvedova A, Svartengren M, Tran L, Wiklund L [2007]. There's plenty of room at the forum: potential risks and safety assessment of engineered nanomaterials. *Nanotoxicol* 1(2):73–84.
  - Kisin ER, Murray AR, Keane MJ, Shi XC, Schwegler-Berry D, Gorelik O, Arepalli S, Castranova V, Wallace WE, Kagan VE, Shvedova AA [2007]. Single-walled carbon nanotubes: geno- and cytotoxic effects in lung fibroblast V79 cells. *J Tox Environ Health A* 70(24):2071–2079.
  - Mercer RR, Scabilloni JF, Wang L, Schwegler-Berry D, Shvedova AA, Castranova V [2007]. Dispersion significantly enhances the pulmonary toxicity of single-walled carbon nanotubes. *Toxicologist* 96(1):A1115.
  - Baron PA, Deye GJ, Chen B-T, Schwegler-Berry D, Shvedova AA, Castranova V [2008]. Aerosolization of single-walled carbon nanotubes for an inhalation study. *Inhal Tox* 20(8):751–760.
  - Shvedova AA, Fabisiak JP, Kisin ER, Murray AR, Roberts JR, Tyurina YY, Antonini JM, Feng WH, Kommineni C, Reynolds J, Barchowsky A, Castranova V, Kagan VE [2008]. Sequential exposure to carbon nanotubes and bacteria enhances pulmonary inflammation and infectivity. *Am J Respir Cell Mol Biol* 38:579–590.
  - Shvedova AA, Kisin E, Murray AR, Kommineni C, Castranova V, Fadeel B, Kagan VE [2008]. Accumulation of neutrophils and decreased fibrosis in NADPH oxidase-deficient C57BL/6 mice exposed to carbon nanotubes. *Tox Appl Pharm* 231(2):235–240.
  - Shvedova AA, Kisin E, Murray AR, Johnson VJ, Gorelik O, Arepalli S, Hubbs F, Mercer RR, Keohavong P, Sussman N, Jin J, Yin J, Stone S, Chen BT, Deye G, Maynard A, Castranova V, Baron PA, Kagan VE [2008]. Inhalation versus aspiration of single-walled carbon nanotubes in C57BL/6 mice: inflammation, fibrosis, oxidative stress, and mutagenesis. *Am J Physiol Lung Cell Mol Physiol* 295(4):L552–565.
  - Kisin E, Murray A, Keane M, Shi X, Schwegler-Berry D, Gorelik O, Arepalli S, Castranova V, Wallace W, Kagan V, Shvedova A [2008]. Single-walled carbon nanotubes: geno- and cytotoxic effects in lung fibroblast V79 cells. *Toxicologist* 102(1):A441.
  - Murray AR, Kisin E, Fabisiak JP, Roberts JR, Antonini JM, Kommineni C, Reynolds J, Barchowsky A, Castranova V, Kagan V, Shvedova AA [2008].





Combined exposure to carbon nanotubes and bacteria-enhanced pulmonary inflammation and infectivity. *Toxicologist* 102(1):A1494.

- Shvedova AA, Kisin E, Murray AR, Johnson V, Gorelik O, Arepalli S, Hubbs AF, Mercer RR, Stone S, Frazer D, Chen T, Deye G, Maynard A, Baron P, Mason R, Kadiiska M, Stadler K, Mouithys-Mickalad A, Castranova V, Kagan VE [2008]. Inhalation of carbon nanotubes induces oxidative stress and cytokine response causing respiratory impairment and pulmonary fibrosis in mice. *Toxicologist* 102(1):A1497.

### Invited Presentations

- Shvedova AA [2005]. Comparative toxicity of nanomaterials in vivo and in vitro. 229th American Chemical Society Meeting, San Diego, California, March 12–16.
- Baron PA, Deye GJ, Shvedova AA, Castranova V [2005]. Generation of very low density fibrous carbon powders (single-walled carbon nanotubes and Pyrograf III). In: Proceedings of the 24th Annual AAAR Conference, Austin, Texas, October 17–21, p. 214.
- Baron PA, Deye GJ, Shvedova AA, Castranova V [2005]. Generation of very low density fibrous carbon powders (single-walled carbon nanotubes and Pyrograf III). In: Proceedings of the 2nd International Symposium on Nanotechnology and Occupational Health, Minneapolis, Minnesota, October 3–6, p. 40.
- Shvedova AA [2007]. Pulmonary toxicity of single-walled nanotubes. International conference on nanotoxicology, Venice, Italy, April 19–21.
- Shvedova AA [2007]. Pulmonary toxicity of nanoparticles. Experimental biology meeting, Washington, DC, April 30–May 3.
- Shvedova AA [2007]. Pulmonary toxicity of single-walled nanotubes in vivo: mechanisms and consequences. National Aeronautics and Space Administration/National Institute of Standards and Technology workshop on nanotube measurements. National Institute of Standards and Technology, Gaithersburg, Maryland, September 26–28.
- Shvedova AA [2007]. Inhalation exposure to single-walled carbon nanotubes. European NanOSH conference. Nanotechnologies: a critical area in occupational safety and health, Helsinki, Finland, December 3–5.
- Shvedova AA [2008]. Single-walled carbon nanotubes: are they mutagenic? Mary Babb Randolph Cancer Center—National Institute of Occupational Safety and Health scientific retreat in cancer, Morgantown, West Virginia, February 12.
- Shvedova AA, Kagan VE [2008]. Pulmonary toxicity of carbon nanotubes in vivo: mechanisms, regulations, and reality. Nanomaterials: environmental risks and benefits and emerging consumer products, Faro, Portugal, April 27–30.



- Shvedova AA [2008]. Carbon nanotube in the rodent lungs: recognition and modulation of toxicity. American Thoracic Society, International Conference, Toronto, Canada, May 16–21.
- Shvedova AA [2008]. Relevance of animal model studies: aspiration vs. inhalation. Second International Conference: Nanotoxicology, Zurich, Switzerland, September 7–10.



## Project 19: Assessment of Engineered Nanomaterials of Respiratory Immunity

Principle Investigator: Anna A. Shvedova, PhD

Project Duration: FY 2009–2012

Critical Topic Areas: Toxicology and internal dose

### Accomplishments and Research Findings

- Found that exposure of SWCNTs with low content of metal impurities to primary human monocyte-derived macrophages (HMDMs) did not exert direct cytotoxicity.
- In vitro exposure indicated that SWCNTs are not chemotactic for human monocyte-derived macrophages. SWCNT suppressed chemotaxis of primary human monocytes.
- Macrophage engulfment of apoptotic target cells was significantly impaired following pre-incubation of HMDMs with SWCNTs at non-cytotoxic concentrations.
- New data are in line with previous results showing that ultrafine carbon particles and SWCNTs impaired alveolar macrophage ingestion of microorganisms, thus suggesting that tissue homeostasis may be compromised by SWCNTs because of their suppressive effects on macrophages.

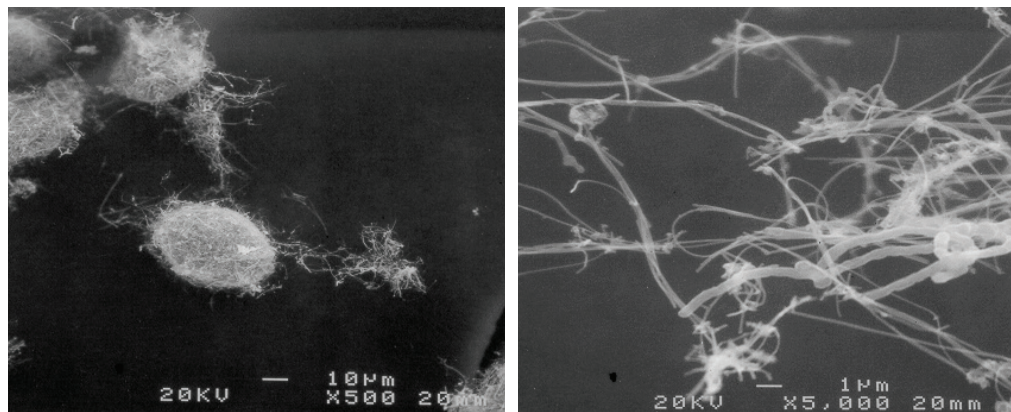

Bulk multi-walled carbon nanotubes observed as an agglomerated “bird’s nest” and as a loose bundle

- Pharyngeal aspiration of pristine (C60) and functionalized fullerenes (C60-TRIS) and SWCNTs causes inflammation and pulmonary damage, demonstrated by accumulation of PMNs, changes in lung permeability, lung cell damage, and cytokine release. Toxicity to the lung: SWCNT > C60-TRIS > C60.
- Pulmonary exposure to fullerenes and SWCNTs causes the release of both proinflammatory (i.e., TNF- $\alpha$ ) and regulatory (i.e., IL-10) cytokines.
- Pulmonary exposure to SWCNTs facilitated the recruitment of dendritic cells to the lung, followed by their subsequent migration to the draining lymph nodes.
- Pulmonary exposure to fullerenes and SWCNTs suppresses systemic immunity. Splenic T cells from mice exposed to NP demonstrated suppressed response after stimulation by dendritic cells (up to 20% lower for control).
- Mechanisms of altered systemic immunity in treated mice may be, at least in part, due to the direct effects of SWCNTs on dendritic cells, as evidenced by the impaired T cell responsiveness to re-stimulation following pre-incubation with SWCNT-exposed dendritic cells (in vitro).

### Publications and Abstracts

- Kisin E, Murray AR, Hubbs AF, Mercer RR, Keohavong P, Sussman N, Chen BT, Deye G, Castranova V, Baron PA, Kagan VE, Shvedova AA [2009]. Pulmonary effects of single walled carbon nanotubes: inhalation vs aspiration. *Toxicologist* 108(1):2202.
- Kisin E, Murray AR, Schwegler-Berry D, Scabilloni J, Mercer RR, Chirila M, Young S, Leonard S, Keohavong P, Fadeel B, Kagan VE, Castranova V, Shvedova AA [2010]. Pulmonary response, oxidative stress and genotoxicity induced by carbon nanofibers. *Toxicologist* 114(1):169.
- Tyurin VA, Tyurina YY, Jung Mi-Y, Tungekar MA, Wasserloos KJ, Bayir H, Greenberger JS, Kochanek PM, Shvedova AA, Pitt B, Kagan VE [2009]. Mass-spectrometric analysis of hydroperoxy- and hydroxy-derivatives of cardiolipin and phosphatidylserine in cells and tissues. *J Chromatogr B Analyt Technol Biomed Life Sci* 877(26):2863–2872.
- Shvedova AA, Kisin ER, Porter D, Schulte P, Kagan VE, Fadeel B, Castranova V [2009]. Mechanisms of pulmonary toxicity and medical applications of carbon nanotubes: two faces of Janus? *Pharm Ther* 121(2):192–204.
- Konduru NV, Tyurina YY, Feng W, Basova LV, Belikova NA, Bayir H, Clark K, Rubin M, Stolz D, Vallhov H, Scheynius A, Witasp E, Fadeel B, Kichambare PD, Star A, Kisin ER, Murray AR, Shvedova AA, Kagan VE [2009]. Phosphatidylserine targets single-walled carbon nanotubes to professional phagocytes in vitro and in vivo. *PLoS One* 4(2):e4398.
- Witasp E, Shvedova AA, Kagan VE, Fadeel B [2009]. Single-walled carbon nanotubes impair human macrophage engulfment of apoptotic cell corpses. *Inhal Toxicol* 21(S1):131–136.



- Shvedova AA, Kagan VE, Fadeel B [2010]. Close encounters of the small kind: adverse effects of man-made materials interfacing with the nano-cosmos of biological systems. *Ann Rev Pharmacol Toxicol* 50:63–88.
- Shvedova AA, Kagan VE [2010]. The role of nanotoxicology in realizing the ‘helping without harm’ paradigm of nanomedicine: lessons from studies of pulmonary effects of single-walled carbon nanotubes. *J Intern Med* 267(1):106–118.
- Kagan VE, Konduru NV, Feng W, Allen BL, Conroy J, Volkov Y, Vlasova II, Belikova NA, Yanamala N, Kapralov A, Tyurina YY, Shi J, Kisin ER, Murray AR, Franks J, Stolz D, Gou P, Klein-Seetharaman J, Fadeel B, Star A, Shvedova AA [2010]. Carbon nanotubes degraded by neutrophil myeloperoxidase induce less pulmonary inflammation. *Nat Nanotechnol* 5(5):354–359.
- Kagan VE, Shi J, Feng W, Shvedova AA, Fadeel B [2010]. Fantastic voyage and opportunities of engineered nanomaterials: what are the potential risks of occupational exposures? *J Occup Environ Med* 52(9):943–946.
- Kisin ER, Murray AR, Sargent L, Lowry D, Chirila M, Siegrist KJ, Schwegler-Berry D, Leonard S, Castranova V, Fadeel B, Kagan VE, Shvedova AA [2011]. Genotoxicity of carbon nanofibers: are they potentially more or less dangerous than carbon nanotubes or asbestos? *Toxicol Appl Pharmacol* 252(1):1–10.
- Teeguarden JG, Webb-Robertson BJ, Waters KM, Murray AR, Kisin ER, Varnum SM, Jacobs JM, Pounds JG, Zanger RC, Shvedova AA [2011]. Comparative proteomics and pulmonary toxicity of instilled single-walled carbon nanotubes, crocidolite asbestos, and ultrafine carbon black in mice. *Toxicol Sci* 120(1):123–135.
- Tkach A, Shurin M, Shurin G, Kisin, Murray, AR, Yang, Houg S, Star A, Bengt F, Kagan VE, Shvedova AA [2011]. Direct effects of carbon nanotubes on dendritic cells induce immune suppression upon pulmonary exposure. *ACS Nano* 5(7):5755–5762.
- Tyurina YY, Kisin ER, Murray A, Tyurin VA, Kapralova VI, Sparvero LJ, Amoscato AA, Samhan-Arias AK, Swedin L, Lahesmaa R, Fadeel B, Shvedova AA, Kagan VE [2011]. Global phospholipidomics analysis reveals selective pulmonary peroxidation profiles upon inhalation of single-walled carbon nanotubes. *ACS Nano* 5(9):7342–7353.
- Mohamed BM, Verma NK, Davies AM, McGowan A, Staunton KC, Prina-Mello A, Kelleher D, Botting CH, Causey CP, Thompson PR, Pruijn GJM, Kisin ER, Tkach AV, Shvedova AA, Volkov Y [2012]. Citrullination of proteins: a common post-translational modification pathway induced by different nanoparticles in vitro and in vivo. *Nanomedicine* 7(8):1181–1195.
- Murray AR, Kisin ER, Tkach AV, Yanamala N, Mercer R, Young S-H, Fadeel B, Kagan VE, Shvedova AA [2012]. Factoring-in agglomeration of carbon nanotubes and nanofibers for better prediction of their toxicity versus asbestos. *Particles Fibre Toxicol J* 9:10.

## Invited Presentations

- Kisin E, Murray AR, Mercer RR, Keohavong P, Fadeel B, Kagan VE, Shvedova AA [2009]. Pulmonary and genotoxic effects of nanofibers. 6th International Key Symposium on Nanomedicine, Stockholm, Sweden, September 9–11.
- Shvedova AA [2009]. Nanotoxicology in vivo: Pulmonary effects of carbon nanotubes. 6th Symposium on Nanomedicine, Royal Swedish Academy of Sciences, Stockholm, Sweden, September 9–11.
- Shvedova AA [2009]. Unsolicited pulmonary effects of carbon nanotubes: genetic, nutritional and microbial factors. 4th Oxygen/Nitrogen Radicals and Cellular Injury Meeting, NY Academy of Sciences, New York, New York, October 28–30.
- Shvedova AA [2010]. Toxicity of carbon nanotubes: from mechanisms to regulatory consequences. Nanoscience and Technology in Chemistry, Health, Environment and Energy, International Conference, Agra, India, January 6–9.
- Shvedova AA [2010]. Oxidative stress, pulmonary toxicity of single walled carbon nanotubes in vivo: relevance to occupational exposures. International Conference on Advances in Free Radicals Research, Natural Products, Anti-oxidants and Radio-protectors in Health/9th Annual Meeting of Society for Free Radical Research, Hyderabad, India, January 11–13.
- Shvedova AA [2010]. Toxicity of carbon nanotubes: acute, long-term effects and mechanisms. 3rd Nanotoxicology Conference, Edinburgh, Scotland, June 2–4.
- Shvedova AA [2010]. Pulmonary toxicity of single-walled carbon nanotubes: inflammation, fibrosis, mutagenic effects. 2nd Nobel Forum, Understanding the Interactions of Engineered Nanomaterials with Biological Systems, Stockholm, Sweden, October 23.
- Kisin E, Murray AR, Schwegler-Berry D, Scabilloni J, Mercer RR, Chirila M, Young S, Leonard S, Keohavong P, Fadeel B, Kagan VE, Castranova V, Shvedova AA [2010]. Pulmonary response, oxidative stress and genotoxicity induced by carbon nanofibers. NTRC 2010 Update, Wheeling, West Virginia, April 19–21.
- Kisin E, Murray AR, Schwegler-Berry D, Mercer RR, Keohavong P, Fadeel B, Castranova V, Kagan VE, Shvedova AA [2010]. Assessment of pulmonary outcomes following exposure to fibrous nanomaterials. Nanotoxicology 2010, Edinburgh, UK, June 2–4, p. 105.
- Tkach A, Shurin GV, Shurin MR, Star A, Kisin E, Murray AR, Fadeel B, Kagan VE, Shvedova AA [2010]. Study of immunomodulating properties of pristine and functionalized fullerenes. A-E 24th SOT meeting, Pittsburgh, Pennsylvania, April 30.
- Shvedova AA [2011]. Pulmonary toxicity of single-walled carbon nanotubes: inflammation, fibrosis, and mutagenic effects. Nanocomposite and Nanotube European Meeting, Brussels, Belgium, April 6–7.



- Shvedova AA [2011]. Assessment of quantitative changes in biomarkers of immune, inflammatory, and oxidative stress. 4th Annual Consortium Meeting, Karolinska Institutet, Contract Agreement: NMP4-SL-2008-214281; Stockholm, Sweden, June 16.
- Shvedova AA [2011]. FP7-NANOMMUNE Workshop: understanding nano-immuno-interactions; Pulmonary Toxicity of Carbonaceous Nanomaterials versus Asbestos Fibers, Stockholm, Sweden, June 17.
- Shvedova AA [2011]. Nanoparticles as an emerging environmental and occupational hazard: does oxidative stress matter? Environmental stresses in biology and medicine. 2nd International Meeting, Siena, Italy, October 5–7.
- Shvedova AA [2011]. Carbon nanotubes: from safety assessment to biomedical applications. Workshop: in vivo studies. Carbon Nanomaterials versus Asbestos: Immune Effects, 7th FP, EU Commission, Brussels, Belgium, November 29.



## Project 20: Dermal Toxicity of Nanotube Particles

**Principal Investigator:** Anna Shvedova, PhD

**Project Duration:** FY 2005–2010

**Critical Topic Area:** Toxicology and internal dose

### Accomplishments and Research Findings

- SWCNTs induced genotoxic and cytotoxic effects in lung fibroblast V79 cells when assessed using different test systems: the comet and micronucleus assays.
- Engineered human skin exposed to unpurified SWCNTs showed increased epidermal thickness and accumulation and activation of dermal fibroblasts with increased collagen level and release of proinflammatory cytokines.
- Exposure of murine epithelial JB6 P+ cells to unpurified SWCNTs (30% iron) resulted in the production of ESR detectable hydroxyl radicals and caused a significant dose-dependent activation of AP-1.
- Detected no significant changes in AP-1 activation when partially purified SWCNTs (0.23% iron) were introduced to JB6 P+ cells.



Nanomaterial worker





- Topical exposure of SKH-1 mice to unpurified SWCNT induced free radical generation, oxidative stress, and inflammation, thus causing dermal toxicity.

#### **Exposure to Single-Wall Carbon Nanotubes (SWCNTs):**

- Topical exposure of SWCNTs to skin caused dermal toxicity. Found toxicity is dependent upon the metal (particularly iron) content of SWCNTs as well as its ability to penetrate the skin and induce oxidative stress/leading inflammation.
- Topical exposure of SKH-1 mice to SWCNT exposure (2 mg/kg, 4 mg/kg, or 8 mg/kg, 5 days) caused oxidative stress and skin inflammation assessed by increased myeloperoxidase activity, accumulation of PMNs and elevated skin thickness/edema.
- Exposure of human keratinocytes (HaCaT) cells revealed less cytotoxicity in cells exposed to partially purified SWCNTs (2.5% weight iron) compared to unpurified SWCNT (0.23%; 40% iron).
- Murine epidermal cells (JB6 P+) revealed a significant dose-dependent activation of AP-1 following exposure to unpurified SWCNTs, whereas partially purified SWCNTs did not activate AP-1. On the contrary, activation of NFκB was dose-dependent by both unpurified and partially purified SWCNTs.
- These data indicate that dermal exposure to SWCNTs, particularly unpurified SWCNTs, could result in inflammation, accelerated oxidative stress, and dermal toxicity during direct contact of SWCNTs with occupationally unprotected skin.

#### **Tungsten carbide–cobalt (WC-Co) Exposure:**

- Demonstrated size-dependent effects of tungsten carbide–cobalt (WC-Co) nano/micro sized particles on oxygen radical production and activation of cell signaling pathways in murine epidermal cells.
- Found adverse effects of nano-WC-Co generated a higher level of hydroxyl radicals, greater oxidative stress, and caused accelerated JB6 P(+) cell growth/proliferation. In addition, nano-WC-Co activated AP-1 and NF-kappaB more efficiently in JB6(+/+) cells as compared to micronized WC-Co.
- In AP-1-luciferase reporter transgenic mice was found the activation of AP-1 by nano-WC-Co but not micronized NP.
- Nano- and fine-sized WC-Co particles also stimulated MAPKs, including ERKs, p38, and JNKs with significantly higher potency of nano-WC-Co.
- Co-incubation of the JB6(+/+) cells with N-acetyl-cysteine–antioxidant decreased AP-1 activation and phosphorylation of ERKs, p38 kinase, and JNKs, thus suggesting that oxidative stress is intimately involved in WC-Co-induced toxicity and AP-1 activation.

### Superparamagnetic Iron Oxide Nanoparticles (SPION) Exposure:

- Found that exposure of SPION to Human Epidermal Keratinocytes caused cytotoxic effects.
- Exposure of JB6 mouse epidermal cells to SPION resulted in activation of AP-1.
- Exposure to SPION alone was not sufficient to induce NFκB activation; however, co-exposure with UVB resulted in significant NFκB induction in cells exposed to SPION particles.
- Co-exposure of mouse epidermal cells to UVB and NPs significantly accelerated depletion of glutathione, release of cytokines, and cell damage as assessed by release of lactate dehydrogenase.
- Demonstrated that exposure of iron oxide nanoparticles (SPION) to dermal cells caused size-dependent dermal toxicity via induction of cell damage, oxidative stress, activation of signal transduction pathways and subsequent release of inflammatory mediators.

### Publications and Abstracts

- Murray AR, Kisin E, Kommineni C, Kagan VE, Castranova V, Shvedova AA [2007]. Single-walled carbon nanotubes induce oxidative stress and inflammation in skin. *Toxicologist* 96(1):291.
- Fadeel B, Kagan V, Krug H, Shvedova A, Svartengren M, Tran L, Wiklund L [2007]. There's plenty of room at the forum: potential risks and safety assessment of engineered nanomaterials. *Nanotoxicol* 1(2):73–84.
- Kisin ER, Murray AR, Keane MJ, Shi XC, Schwegler-Berry D, Gorelik O, Arepalli S, Castranova V, Wallace WE, Kagan VE, Shvedova AA [2007]. Single-walled carbon nanotubes: geno- and cytotoxic effects in fibroblast V79 cells. *J Tox Environ Health, Part A*, 70(24):2071–2079.
- Tyurina YY, Basova LV, Konduru NV, Tyurin VA, Potapovich AI, Cai P, Bayir H, Stoyanovsky D, Pitt BR, Shvedova AA, Fadeel B, Kagan VE [2007]. Nitrosative stress inhibits the aminophospholipid translocase resulting in phosphatidylserine externalization and macrophage engulfment: implications for the resolution of inflammation. *J Biol Chem* 282(11):8498–8509.
- Kagan VE, Tyurina YY, Konduru N, Basova LV, Stolz D, Kisin ER, Murray AR, Fadeel B, Shvedova AA [2007]. Targeted delivery of phosphatidylserine coated single-walled carbon nanotubes to macrophages. *Toxicologist* 96(1):233.
- Feng W, Tyurina YY, Bayir H, Shvedova AA, Kagan VE [2007]. Phosphatidylserine enhances recognition and uptake of single-walled carbon nanotubes by rat brain microglial cells. *Toxicologist* 96(1):289.
- Ding M, Zhao J, Bowman L, Leonard S, Lu Y, Kisin E, Murray A, Vallyathan V, Castranova V, Shvedova A [2008]. Induction of AP-1-MAPKs and



NF-KB signal pathways by tungsten carbide–cobalt particles. *Toxicologist* 102(1):A1031.

- Feng W, Konduru NV, Tyurina YY, Clark K, Stolz DB, Bayir H, Fadeel B, Shvedova AA, Kagan VE [2008]. Involvement of endocytosis in uptake of phosphatidylserine-coated single-walled carbon nanotubes by RAW 264.7 macrophages. *Toxicologist* 102(1):213.
- Elder A, Lynch I, Grieger K, Chan-Remillard S, Gatti A, Gnewuch H, Kenawy E-R, Korensten R, Kuhlbusch T, Linker F, Matias S, Monteiro-Riviere N, Pinto V, Rudnitsky R, Savolainen K, Shvedova A [2009]. Disposition of Nanoparticles as a Function of their Interactions with Bio-molecules. In *Nanomaterials Risks and Benefits*, Eds. Linkov & Steevens, Springer, the Netherland, Proceedings of the NATO Advanced Research Workshop on Nanomaterials: Environmental Risks and Benefits Faro, Portugal 27–30 April, 2008, pp 3–29.
- Ding M, Kisin ER, Zhao J, Bowman L, Lu Y, Jiang B, Leonard S, Vallyathan V, Castranova V, Murray AR, Fadeel B, Shvedova AA [2009]. Size-dependent effects of tungsten carbide–cobalt particles on oxygen radical production and activation of cell signaling pathways in murine epidermal cells *Toxicol Appl Pharmacol* 241(3):260–8.
- Murray AR, Kisin E, Leonard SS, Young SH, Kommineni C, Kagan VE, Castranova V, Shvedova AA [2009]. Oxidative stress and inflammatory response in dermal toxicity of single-walled carbon nanotubes. *Toxicology* 29; 257 (3):161–71.
- Murray AR, Kisin E, Leonard SS, Young SH, Kommineni C, Kagan VE, Castranova V, Shvedova AA [2009]. Single-Walled carbon nanotubes: skin exposures. *Toxicologist* 108(1):2201.
- Konduru NV, Tyurina YY, Feng W, Basova LV, Belikova NA, Bayir H, Clark K, Rubin M, Stolz D, Vallhov H, Scheynius A, Witasp E, Fadeel B, Kichambare PD, Star A, Kisin ER, Murray AR, Shvedova AA, Kagan VE [2009]. Phosphatidylserine targets single-walled carbon nanotubes to professional phagocytes in vitro and in vivo. *PLoS One* 4(2):e4398.
- Murray AR, Kisin E, Leonard SS, Young SH, Schwegler-Berry D, Castranova V, Fadeel B, Kagan VE, Shvedova AA [2010]. Toxic effects of metal/metal oxide nanoparticles in skin model. *Toxicologist* 114(1):270.
- Murray AR, Kisin E, Inman A, Young SH, Muhammed M, Burks T, Uheida A, Tkach A, Waltz M, Castranova V, Fadeel B, Kagan VE, Riviere JE, Monteiro-Riviere N, Shvedova AA [2011]. Oxidative stress and dermal toxicity of iron oxide nanoparticles in vitro. *Cell biochem and biophys* [in press].

### Invited Presentations

- Ding M, Lu Y, Bowman L, Leonard S, Castranova V, Vallyathan V [2006]. Titanium nanoparticles induces AP-1 activation through ROS and MAPKS

- pathways. 1st International Toxicology of Nanomaterial: Biomedical Aspects Meeting, Miami Beach, Florida, January 29–February 1.
- Murray AR, Kisin E, Castranova V, Kommineni C, Kagan VE, Shvedova AA [2006]. Oxidative stress and inflammatory response in dermal toxicity of single-walled carbon nanotubes. 1st International Toxicology of Nanomaterial: Biomedical Aspects Meeting, Miami Beach, Florida, January 29–February 1.
  - Shvedova AA [2008]. Single-walled carbon nanotubes: are they mutagenic? Mary Babb Randolph Cancer Center—National Institute of Occupational Safety and Health scientific retreat in cancer, Morgantown, West Virginia, February 12.
  - Murray AR, Kisin ER, Leonard SS, Kommineni C, Kagan VE, Castranova V, Shvedova AA [2008]. Induction of oxidative stress and inflammation in the skin following exposure to single-walled carbon nanotubes. Zurich, Switzerland, March 12–15.
  - Murray AR, Kisin E, Leonard SS, Young S, Schwegler-Berry D, Castranova V, Fadeel B, Kagan VE, Shvedova AA [2010]. Metal/Metal Oxide Nanoparticle Induced Toxicity in Skin Model. Nanotoxicology 2010, Edinburgh, UK, June 2–4.
  - Murray AR, Kisin E, Leonard SS, Castranova V, Kagan VE, Shvedova AA [2009]. Assessment of Toxic Outcomes of metal/metal oxide nanoparticles in skin model in vitro and in situ. 6th Key Symposium on Nanomedicine, Stockholm, Sweden, September 9–11.
  - Murray AR, Kisin E, Leonard SS, Castranova V, Kagan VE, Shvedova AA [2010]. Toxic Effects of Metal/Metal Oxide Nanoparticles in Skin Model. NTRC 2010 Update, Wheeling, West Virginia, April 19–21.



## Project 21: Bioassay Screen of Lung Toxicity of Silver Nanoparticles

**Principle Investigator:** Jenny R. Roberts, PhD

**Project Duration:** FY 2010–2012

**Critical Topic Areas:** Toxicology and internal dose

### Accomplishments and Research Findings

- Established collaboration with researchers at NIST and DRDS/NIOSH to conduct a physical characterization of a battery of silver nanoparticles (Ag NPs) to be employed in the study, including uncoated particles, particles with a polyvinylpyrrolidone (PVP) coating, and citrate-suspended particles. Surface area measurements on the dry powder form of the Ag NPs, hydrodynamic particle sizing in dispersion medium, and size evaluation of the particle suspension in dispersion medium by electron microscopy have been evaluated for the uncoated Ag NPs and the PVP-coated particles. Based on the characterization and OECD recommendations, the emphasis of the project will be on Ag NPs with PVP and citrate-suspended Ag NPs.
- Established collaboration with nanoComposix and Air Force Research Laboratory to investigate pulmonary toxicity associated with an additional form of silver nanomaterial, silver nanowires of different lengths. NanoComposix has generated, characterized, and supplied us with nanowires of two different lengths. The Air Force Research Lab has begun in vitro analysis of toxicity using a variety of pulmonary cell types.
- Conducted a pilot study in vivo to determine if the PVP coating itself possessed any toxic properties related to the bioassay screen that may interfere with evaluation of the pulmonary toxicity of Ag NPs. PVP, at the concentration that it exists in the highest proposed dose of Ag NPs, did not produce any inflammation, injury, or alteration in immune parameters in the lung.
- Completed an in vivo dose-response time course study evaluating pulmonary toxicity of PVP-coated Ag NPs after a single acute exposure in rats. Ag NPs caused a dose-dependent increase in pulmonary injury and inflammation. In addition, Ag NPs induced alterations in immune parameters in the lung and in lung-associated lymph nodes. Increases in lung injury and inflammation, and alterations in immune parameters, persisted for at least one month post-exposure in a dose-dependent manner.
- Completed an in vivo dose-response time course study evaluating toxicity of PVP-coated Ag NPs after repeated exposures (1x per week for 8 weeks) to doses in the lower range of the single acute dose-response time course study. Repeated exposure to the lowest dose in this study caused no significant lung

injury or inflammation. Exposure to the higher dose in this study caused significant inflammation and injury up to one month after the last exposure, with resolution over time.

- Characterized two silver nanowire samples that differ in length and evaluated pulmonary toxicity associated with them in vivo based on lung lavage cell and fluid analysis. Both samples cause a dose-dependent increase in lung injury and inflammation, with a more severe response at days one and seven post-exposure with the long wire sample, while the short wire sample caused a more persistent response at the later time points post-exposure.

### Publications and Abstracts

- Roberts JR, Chapman RS, Young S-H, Kenyon A, Schwegler-Berry D, Stefaniak AB, Chen BT, Antonini JM [2011]. Pulmonary Toxicity Following Intratracheal Instillation of Dispersed Silver Nanoparticles in Rats. Society of Toxicology Annual Meeting, Washington, DC, March 6–10th, 2011. *Toxicologist 120*(Suppl 2): A1759, 377–378.
- Schaeublin NM, Estep CA, Roberts JR, Hussain SM [2011]. Silver Nanowires Induced Inflammation in an In vitro Human Alveolar Lung Model. Society of Toxicology Annual Meeting, Washington, DC, March 6–10th, 2011. *Toxicologist 120*(Suppl 2): A2181, 468.
- Roberts JR, Kenyon A, Young SH, Schwegler-Berry D, Hackley VA, MacCuspie RI, Stefaniak AB, Kashon ML, Chen BT, Antonini JM [2012]. Pulmonary Toxicity Following Repeated Intratracheal Instillation of Dispersed Silver Nanoparticles in Rats. Society of Toxicology Annual Meeting, San Francisco, California, March 11–15th, 2012. *Toxicologist*, In Press.
- Kenyon A, Antonini JM, Mercer RR, Schwegler-Berry D, Schaeublin NM, Hussain SM, Oldenburg SJ, Roberts JR [2012]. Pulmonary Toxicity Associated with Different Aspect Ratio Silver Nanowires after Intratracheal Instillation in Rats. Society of Toxicology Annual Meeting, San Francisco, California, March 11–15th, 2012. *Toxicologist*, In Press.



## Project 22: Specific Biomarkers for Unusual Toxicity of Nanomaterials

**Principal Investigator:** Liying Wang Rojanasakul, PhD

**Project Duration:** FY 2007–2009

**Critical Topic Area:** Toxicology and internal dose

### Accomplishments and Research Findings

- In vitro cellular models were developed for fibrogenic and biomarker studies of CNTs, such as collagen and collagenase production from fibroblasts and TGF- $\beta$  production from lung epithelial cells.
- Data from this project provided important preliminary findings used in obtaining NORA grant funding.

### Publications and Abstracts

- Wang L, Castranova V, Rojanasakul Y, Lu Y, Scabilloni J, Mercer RR [2008]. Direct fibrogenic effects of dispersed single-walled carbon nanotubes on human lung fibroblasts. Society of Toxicology Annual Meeting, Washington, DC, March 16–20. *Toxicologist* 102:A1499.
- Mercer RR, Scabilloni JF, Wang L, Kisin E, Murray A, Schwegler-Berry D, Shvedova A, Castranova V [2008]. Alteration of deposition pattern and pulmonary response as a result of improved dispersion of aspirated single walled carbon nanotubes in a mouse model. *Am J Physiol Lung Cell Mol Physiol* 294(1):L87–97.
- Lu Y, Azad N, Wang L, Iyer AKV, Castranova V, Jiang BH, Rojanasakul Y [2009]. Phosphatidylinositol-3-Kinase/Akt Regulates Fibrogenesis in Human Lung Fibroblasts. *Am J Respir Cell Mol Biol* 42(4):432–41.
- Wang L, Rojanasakul Y, Castranova V, Qiu A, Lu Y, Scabilloni J, Wu N, Mercer RR [2010]. Direct fibrogenic effects of dispersed single-walled carbon nanotubes on human lung fibroblasts. *J Toxicol Environ Health A* 73(5):410–22.

### Invited Presentations

- Wang L [2007]. Carbon nanotubes exhibit tumorigenic and fibrogenic potential in vitro. West Virginia University research meeting, Morgantown, West Virginia, September 1.
- Wang L [2008]. Meeting with the National Institute of Occupational Health and Poison Control on nanotoxicology research, Beijing, China, November 16 and 17.



- Castranova V [2008]. The ability of in vitro tests to predict pulmonary responses to SWCNT. John Hopkins University, Baltimore, Maryland, June 11.
- Wang L, Castranova V, Mercer RR, Wu N, Tiao Li T, Li S, Hall J, Li M, Rojanasakul Y [2009]. Nanoparticle dispersion method using natural lung surfactant. Society of Toxicology Annual Meeting, Baltimore, Maryland, March 15–19.
- Mishra A, Hall J, Wang L [2009]. Assessment of pulmonary toxicity of dispersed carbon nanotubes. WVU-Van-Liere Convocation and Research Day, Morgantown, West Virginia, April 27.



## Project 23: Pulmonary Toxicity of Diesel Exhaust Particles

**Principal Investigator:** Jane Ma, PhD

**Project Duration:** FY 2003–2008

**Critical Topic Areas:** Toxicology and internal dose

### Accomplishments and Research Findings

- Studies have shown that diesel-exhaust-particle (DEP) exposure induces lung inflammation and injury, which are mediated through reactive oxygen/nitrogen species (ROS/RNS) generation by alveolar macrophages (AMs).
- C57B/6J wild type (WT) and iNOS knockout (iNOS KO) mice were exposed to saline, carbon black (35 mg/kg), or organic extract of DEP (DEPE) by aspiration and sacrificed at 1, 3, and 7 days postexposure. Carbon black but not DEPE significantly induced neutrophil infiltration in both WT and iNOS KO mice.
- Exposure to carbon black but not to DEPE results in inflammatory lung injury, suggesting that DEP-induced pulmonary inflammation is derived from the particulate. Nitric oxide (NO) does not play a significant role in carbon-black-induced infiltration of polymorphonuclear neutrophils (PMNs), air/capillary damage, and cytotoxicity.
- Carbon-black-exposed AMs exhibited enhanced superoxide anion generation, peaking at 3 days post exposure. Carbon black exposure also induced mitochondrial damage, monitored as reduction of mitochondrial membrane potential in AMs, which was not markedly affected by the NO deficiency. In contrast, DEPE did not significantly induce ROS generation or mitochondrial function in AMs.
- Carbon black and DEPE did not significantly affect adenosine triphosphate (ATP) levels in either WT or iNOS KO mice. This is due to the fact that mitochondrial oxidative phosphorylation pathway is not the major energy source for AMs.
- Transmission electron microscopy analysis has shown that animals exposed to DEPs or carbon black, but not DEPE, were heavily laden with particle-filled vacuoles in the lung.
- Found that vacuoles containing DEPs from DEP-exposed animals were frequently associated with mitochondria or were in direct membrane-to-membrane contact with mitochondria, demonstrating that mitochondrial function was compromised. In contrast, carbon-black-filled vacuoles did not display functionally impaired mitochondria, and no intracellular vacuoles were found in animals exposed to DEPE.

- DEP and carbon black both induced DNA damage in AMs, according to comet assay findings. DEPE did not.

### Publications and Abstracts

- Ma JYC, Millecchia L, Barger MW, Ma JKH, Castranova V [2007]. Diesel exhaust particle-induced oxidant injury and cellular responses in wild type and inducible nitric oxide synthase-deficient (iNOS KO) mice: roles of particle core and adsorbed organics. *Toxicologist* 96(S-1):A183.
- Yin XJ, Dong CC, Ma JYC, Roberts JR, Antonini J, Ma JKH [2007]. Suppression of phagocytic and bactericidal functions of rat alveolar macrophages by the organic component of diesel exhaust particles. *J Toxicol Environ Health A* 70(10):820–822.
- Hongwen Z, Ma JK, Mercer R, Millecchia L, Barger MW, Castranova V, Ma JY [2009]. Reactive oxygen/nitrogen species-mediated lung inflammation and mitochondrial dysfunction in wild type and iNOS deficient mice exposed to diesel exhaust particles. *J Toxicol Environ Health A* 72(8):560–570.

### Invited Presentations

- Ma JYC [2008]. Effects of exposure to diesel exhaust particles on the susceptibility of the lung to infection. The Feinstein Institute for Medical Research, Manhasset, New York, April 8.



## Project 24: Induction of Lung Fibrosis by Cerium Oxide in Diesel Exhaust

**Principal Investigator:** Jane Ma, PhD

**Project Duration:** FY 2009–2012

**Critical Topic Areas:** Toxicology and internal dose

### Accomplishments and Research Findings

#### In vitro studies

- Cerium oxide did not induce intracellular oxidant generation or alter mitochondrial function of alveolar macrophages (AMs) but significantly damaged AM membrane integrity, induced apoptosis, affected macrophage inflammatory responses (including increased TNF- $\alpha$ ) but reduced IL-12 production. These results suggest that cerium oxide can cause direct cellular damage to AM.
- Performed tests suggest that cerium oxide, under co-exposure, may elicit new cellular toxicity in addition to DEP-induced toxicity and that cerium oxide suppresses cellular defense capability.

#### In vivo studies

- Found that cerium oxide administered intratracheally to Sprague Dawley rats induced significant neutrophil infiltration and elevated lactate dehydrogenase activity and albumin content in the BAL fluid, suggesting that these particles induced inflammation, cytotoxicity, and epithelial damage.
- Cerium oxide exposure increased reactive oxygen species production in response to zymosan challenge, as indicated by enhanced chemiluminescence generation.
- Cerium oxide exposure significantly reduced AM production of NO in response to ex vivo LPS challenge but further increased IL-12 production at 1 day post-exposure.
- Exposure of rats to cerium oxide induced Arg-1 at 28 days, but not 1 day, post-exposure. The induced OPN mRNA expression was increased at 1 day and sustained through 28 days of exposure, suggesting that these particle exposures play a direct role in skewing AM development away from M1 towards M2.
- Cerium oxide exposure significantly increased the phospholipid content in the BAL fluid in a dose-dependent manner. TEM showed a significant number of lamellar bodies in AM.

- Cerium oxide induced lung fibrosis in a dose-dependent manner. The fibrosis is measured via increased hydroxyproline content in the lung tissues.
- Cerium oxide induced fibrotic cytokine OPN and TGF- $\beta$ 1 production and phospholipidosis.
- Cerium oxide induced MMP-2, -9, and TIMP-1, resulting in imbalance of the MMP-9/ TIMP-1 ratio that favors fibrosis.
- Cerium oxide-induced lung fibrosis was evident by morphometric analysis of the lung tissues, which detected significantly increased localized collagen formation via Sirius Red staining.
- Cerium oxide particles were detected in lung tissue, AMs, and fibroblasts.
- Intratracheal instillation of cerium oxide nanoparticles also resulted in liver damage, which occurred through extrapulmonary translocation of the particles into the systemic circulation.

### Publications and Abstracts

- Ma JY, Hongwen Z, Barger M, Castranova V, Ma JK [2008]. Effects of cerium oxide on rat primary alveolar macrophages. *Toxicologist* 102(1):A1513.
- Ma JY, Hongwen Z, Barger M, Rao M, Meighan T, Castranova V, Ma JK [2009]. Pulmonary responses to diesel fuel catalyst cerium oxide nanoparticles. *Toxicologist* 108(S-1):49.
- Hongwen Z, Ma JK, Mercer R, Millecchia L, Barger MW, Castranova V, Ma JY [2009]. Reactive oxygen/nitrogen species-mediated lung inflammation and mitochondrial dysfunction in wild type and iNOS deficient mice exposed to diesel exhaust particles. *J Toxicol Environ Health A* 72(8):560–570.
- Ma JY, Zhao H, Mercer RR, Barger M, Rao M, Meighan T, Schwegler-Berry D, Castranova V, Ma JK [2011]. Cerium oxide nanoparticle-induced pulmonary inflammation and alveolar macrophage functional change in rats. *Nanotoxicology* 5:312–325. Epub 2010 October 6.
- Ma JY, Mercer RR, Rao M, Barger M, Meighan T, Castranova V, Ma JK [2010]. Cerium oxide, a diesel fuel catalyst, induces pulmonary fibrosis. *Toxicologist* 114(S-1):55–56.
- Ma JY, Mercer RR, Rao M, Barger M, Meighan T, Ma JK, Castranova V [2011]. Matrix metalloproteinases 2 and 9 and tissue inhibitors of metalloproteinase 1 in cerium oxide induced pulmonary fibrosis. *Toxicologist* 120(S-2):446.
- Nalabotu SK, Kolli MB, Triest WE, Ma JY, Manne ND, Katta A, Addagarla HS, Rice KM, Blough ER [2011]. Intratracheal instillation of cerium oxide nanoparticles induces hepatic toxicity in male Sprague-Dawley rats. *Int J Nanomedicine* 6:2327–2335.



- Ma JY, Mercer RR, Barger M, Ma JK, Castranova V [2011]. Effects of cerium oxide nanoparticles on diesel exhaust particles–induced pulmonary responses. 2012 SOT Annual Meeting [accepted].
- Dolash BD, Barger MW, Castranova V, Ma JY [2011]. Effects of combined exposure to diesel exhaust particles and cerium oxide nanoparticles on the response to endotoxin in rats. 2012 SOT Annual Meeting [accepted].
- Nalabotu SK, Manne N, Kolli MB, Nandyala G, Para RK, Valentovic M, Rice K, Ma JY, Blough ER [2011]. Evaluation of oxidative stress and apoptosis in the liver following a single intratracheal instillation of cerium oxide nanoparticles in male Sprague Dawley rats. 2012 SOT Annual Meeting [accepted].

## Project 25: Potential Effects of Silicon-based Nanowires on Lung Toxicity

**Principle Investigators:** Stephen S. Leonard, PhD, and Jenny R. Roberts, PhD

**Project Duration:** FY 2008–2012

**Critical Topic Areas:** Toxicology and internal dose

### Accomplishments and Research Findings

- Completed physical characterization of silicon-based nanowires generated by IBM and titanium nanowires to be used as a control/reference material.
- Characterized and quantified nanowire-associated reactive oxygen species (ROS), using a cell-free model system, and quantified nanowire-induced free radical generation in vitro in alveolar macrophages.
- Measured and evaluated pulmonary toxicity parameters in vivo, using a titanium nanowire to assess the potential of the material as a control. The titanium nanowires were found to induce a transient, dose-dependent response in the lungs of rats that included increases in indicators of inflammation and oxidative stress.
- Evaluated the ability of pulmonary exposure to titanium nanowires to alter responses to a pulmonary infection. Only the highest dose of nanowires altered response to infection, inducing an increase in resolution of infection over time.
- Evaluated a potential fluorescent marker, quantum dots, for tracking distribution of nanomaterials in the lung.
- Completed an *in vivo* dose-response time course study evaluating pulmonary toxicity of silicon nanowires for up to 3 months after exposure in rats. Silicon nanowires caused a dose-dependent increase in lung injury, inflammation, and immune parameters that was transient, resolving approximately one week after exposure.
- Evaluated distribution and clearance of silicon nanowires after intratracheal instillation in rats, using morphometric analyses. At a dose that induced inflammation early after exposure, the clearance half-life was calculated to be approximately 19 days, and 80% of the deposited material was cleared after 3 months. All of the nanowires were located within the alveolar region by day 1 post-exposure. By 1 week post-exposure the bulk of the material had been phagocytized by alveolar macrophages, and by 3 months post-exposure the 20% of instillate that remained was contained entirely in alveolar macrophages.





- Conducted histological and morphological analysis of lung tissue following pulmonary exposure to silicon nanowires to assess the potential of the nanowires to induce fibrotic disease. Histological analysis revealed no overt signs of fibrosis throughout the 3-month time course; however, at 1 and 3 months post-exposure, morphometric analysis indicated a slight thickening of connective tissue at doses that induced inflammation at earlier time points.
- Evaluated alterations in lung immune responses in rats following pulmonary exposure to silicon nanowires. A dose-dependent increase in lymphocytes and eosinophils in the lungs was found to persist for up to 1 week post-exposure, and rats challenged with a pulmonary bacterial infection following exposure to nanowires had a heightened immune response, resulting in increased clearance of the bacteria from the lungs.

### Publications and Abstracts

- Roberts JR, Mercer RR, Young S-H, Porter DW, Castranova V, Antonini JM [2007]. Inflammation and fate of quantum dots following pulmonary treatment of rats. Society of Toxicology Annual Meeting, Charlotte, North Carolina, March 25–29. *Toxicologist* 96:230.
- Leonard SS, Castranova V, Chen BT, Schwegler-Berry D, Hoover M, Piacitelli C, Gaughan D [2007]. Particle-size-dependent radical generation from wild-land fire smoke. *Toxicology* 236:103–113.
- Pacurari M, Yin XJ, Zhao J, Ding M, Leonard SS, Schwegler-Berry D, Ducatman BS, Sbarra D, Hoover MD, Castranova V, Vallyathan V [2008]. Raw single-wall carbon nanotubes induce oxidative stress and activate MAPKs, AP-1, NF- $\kappa$ B, and Akt in normal and malignant human mesothelial cells. *Environ Health Perspect* 116(9):1211–1217.
- Roberts JR, Schwegler-Berry D, Leonard SS, Karim A, Tirumala V, Antonini JM, Castranova V [2008]. Pulmonary toxicity associated with nondispersed titanium dioxide nanorods. Society of Toxicology Annual Meeting, Seattle, Washington, March 16–20 *Toxicologist* 102:308.
- Ding M, Zhao J, Bowman LL, Leonard SS, Lu Y, Vallyathan V, Castranova V, Shvedova AA [2008]. Induction of AP-1-MAPKs and NF- $\kappa$ B signal pathways by tungsten carbide–cobalt particles. *Toxicologist* 102:212, A1031.
- Roberts JR, Antonini JM, Porter DW, Castranova V, Mercer RR [2008]. Characterization of pulmonary responses following treatment of rats with fluorescently labeled quantum dots with different surface functional groups. American Thoracic Society International Conference, Toronto, Ontario, Canada, May 16–17, 2008. *Am J Respir Crit Care Med* 117:A49.
- Murray AR, Kisin E, Leonard SS, Young S, Kommineni CV, Kagan CE, Castranova V, Shvedova AA [2009]. Oxidative stress and inflammatory response in dermal toxicity of single-walled carbon nanotubes. *Toxicology* 257(3):161–171.

- Pacurari M, Yin XJ, Ding M, Leonard S, Schwegler-Berry D, Ducatman BS, Endo M, Castranova V, Vallyathan V [2008]. Oxidative and molecular interactions of multi-wall carbon nanotubes (MWCNT) in normal and malignant human mesothelial cells. *Nanotoxicology* 2(3):155–170.
- Roberts JR, Schwegler-Berry D, Chapman R, Antonini JM, Scabilloni JF, Castranova V, Mercer RR [2009]. Biodistribution of quantum dots after pulmonary exposure in rats. Society of Toxicology Annual Meeting, Baltimore, Maryland, March 16–18. *Toxicologist* 108:49, A240.
- Chapman R, Roberts JR, Castranova V, Leonard SS [2009]. Generation of reactive oxygen species by silicon nanowires. Society of Toxicology Annual Meeting, Baltimore, Maryland, March 16–18. *Toxicologist* 108:184, A888.
- Roberts JR, Chapman RS, Cohen GM, Bangsaruntip S, Schwegler-Berry D, Antonini JM, Leonard SS [2010]. Assessment of pulmonary toxicity following intratracheal exposure to silicon nanowires. Society of Toxicology Annual Meeting, Salt Lake City, Utah, March 7–11. *Toxicologist* 114:297, A1400.
- Leonard SS, Chen TB, Stone S, Schwegler-Berry DE, Kenyon A, Frazer DG, Antonini JM [2010]. Comparison of stainless and mild steel welding fumes in generation of reactive oxygen species. *Part Fibre Toxicol* 7:32.
- Rushton EK, Jiang J, Leonard SS, Eberly S, Castranova V, Biswas P, Elder A, Gelein R, Finkelstein J, Oberdorster G [2010]. Concept of assessing nanoparticle hazards considering nanoparticle dose-metric and chemical/biological response-metric. *J Toxicol Environ Health* 73(5):445–461.
- Kisin E, Murray A, Schwegler-Berry DE, Scabilloni JF, Mercer R, Chirila M, Young S, Leonard SS, Keohavong P, Fadeel B, Kagan VE, Castranova V, Shvedova AA [2010]. Pulmonary response, oxidative stress and genotoxicity induced by carbon nanofibers [abstract]. *Toxicol Sci* 114(1):176.
- Murray A, Kisin E, Leonard SS, Young S, Schwegler-Berry DE, Castranova V, Fadeel B, Kagan VE, Shvedova AA [2010]. Toxic effects of metal/metal oxide nanoparticles in skin model [abstract]. *Toxicologist* 114(1):58.
- Roberts JR, Chapman RS, Leonard SS, Cohen GM, Bangsaruntip S, Scabilloni JF, Antonini JM, Mercer RR [2010]. Analysis of distribution and clearance of silicon nanowires after pulmonary exposure in rats. American Thoracic Society International Conference, New Orleans, LA, May 14–19. *Am J Respir Crit Care Med* 181:A3092.
- Porter DW, Hubbs AF, Mercer R, Wu N, Wolfarth M, Sriram K, Leonard SS, Battelli LA, Schwegler-Berry DE, Friend S, Andrew ME, Chen TB, Tsuruoka S, Endo M, Castranova V [2010]. Mouse pulmonary dose- and time course-responses induced by exposure to multi-walled carbon nanotubes. *Toxicology* 269(2–3):136–147.



- Wang J, Tafen D, Zheng J, Lewis JP, Leonard SS, Manivannan A, Wu N [2010]. Shape-enhanced photocatalytic activity of anatase TiO<sub>2</sub> (101) nanobelts. *J Am Chem Soc* 132(19):6679–6685.
- Roberts JR, Chapman RS, Tirumala VR, Karim A, Chen BT, Schwegler-Berry D, Stefaniak AB, Leonard SS, Antonini JM [2011]. Toxicological evaluation of lung responses after intratracheal exposure to non-dispersed titanium dioxide nanorods. *J Toxicol Environ Health* 74(12):790–810.
- Roberts JR, Mercer RR, Chapman RS, Guy GM, Bangsaruntip S, Schwegler-Berry D, Scabilloni JF, Castranova V, Antonini JM, Leonard SS [2012]. Pulmonary toxicity, distribution, and clearance of intratracheally-instilled silicon nanowires in rats. *J Nanomaterials* [submitted].

### Invited Presentations

- Leonard SS, Kenyon AJ, Chapman R, Schwegler-Berry D, Cohen G, Roberts J [2010]. Generation of reactive oxygen species from silicon nanowires [poster]. NIOSH NTRC 2010 Update, Wheeling, West Virginia, April 19–21.
- Leonard SS [2010]. Generation of reactive oxygen species from silicon nanowires. PPRB Seminar, NIOSH, Morgantown, West Virginia, July 6.

## Project 26: Workplace Exposure, Inflammation, and Cardiovascular Toxicity

**Principal Investigator:** Aaron Erdely, PhD

**Project Duration:** FY 2010–2014

**Critical Topic Areas:** Toxicology and internal dose

### Accomplishments and Research Findings

- These studies continue the exploration into the systemic effects following an occupational pulmonary exposure.
- Low-dose inhalation exposure to gas metal arc–stainless steel (GMA-SS) welding fume showed an immunomodulatory response in C57BL/6J mice. Microarray analysis indicated a specific immune-mediated signature evident in the blood and aorta. The pathway was also a top network in the lung analysis, supporting the concept of a systemic signature reflecting the ongoing pulmonary response.



Nanomaterial worker



- This study utilized a unique approach by simultaneously exploring molecular signaling in multiple compartments (lung, circulation, and vasculature). This approach has the utility to identify consistent, prominent, and/or novel pathways induced by a toxicant exposure.
- Low-dose inhalation exposure to GMA-SS welding fume showed a low-grade systemic inflammatory and oxidative response in atherosclerotic prone apoE<sup>-/-</sup> mice. Inhalation of GMA-SS welding fume increased progression of atherosclerosis.
- Studies using various types of welding fume provided findings regarding pulmonary and systemic markers of exposure. The measurable stress response in the vasculature was related to the initial cytotoxicity resulting from particle exposure. Systemic inflammation was related to the temporal increase in pulmonary inflammatory gene expression.
- Studies to evaluate circulating markers after carbon nanotube (CNT) exposure showed increased systemic inflammatory mediators, a consistent eosinophilic response, and elevated acute-phase proteins related to immune activation.

### Publications and Abstracts

- Erdely A, Zeidler-Erdely PC, Liston A, Salmen-Muniz R, Hulderman T, Antonini JM, Simeonova PP [2010]. Acute systemic inflammation to welding fume: comparison of various types. *Toxicologist* 114(1):463.
- Erdely A, Hulderman T, Zeidler-Erdely PC, Liston A, Salmen-Muniz R, Stone S, Chen BT, Frazer DG, Antonini JM, Simeonova PP [2010]. Effects of inhalation of gas metal arc–stainless steel welding fume on systemic inflammation and atherosclerosis. *Am J Respir Crit Care Med* 181:A1754.
- Zeidler-Erdely, Erdely A, Stone S, Kashon ML, Li S, Antonini JM [2011]. Molecular pathways of pulmonary inflammation following aspiration and inhalation of stainless steel welding fume in mice. *Toxicologist* 120(S-2):2322.
- Hulderman T, Liston AL, Salmen-Muniz R, Young S-H, Zeidler-Erdely PC, Castranova V, Simeonova PP, Erdely A [2011]. Identification of systemic markers from a pulmonary carbon nanotube exposure. *Toxicologist* 120(S-2):1492.
- Erdely A, Hulderman T, Liston AL, Salmen-Muniz R, Stone S, Chen BT, Frazer DG, Li S, Kashon ML, Antonini JM, Simeonova PP, Zeidler-Erdely PC [2011]. Interferon signaling, systemic inflammation and atherosclerosis following welding fume inhalation exposure: from the lung to the blood to the vasculature. *Toxicologist* 120(S-2):185.
- Erdely A, Hulderman T, Salmen-Muniz R, Liston A, Zeidler-Erdely PC, Chen BT, Stone S, Frazer DG, Antonini JM, Simeonova PP [2011]. Inhalation exposure of gas-metal arc stainless steel welding fume increased atherosclerotic lesions in apolipoprotein E knockout mice. *Toxicol Lett* 204(1):12–16.

- Erdely A, Liston A, Salmen-Muniz R, Hulderman T, Young S-H, Zeidler-Erdely PC, Castranova V, Simeonova PP [2011]. Identification of systemic markers from a pulmonary carbon nanotube exposure. *J Occup Environ Med* 53(6 Suppl):S80– S86.
- Erdely A, Salmen-Muniz R, Liston A, Hulderman T, Zeidler-Erdely PC, Antonini JM, Simeonova PP [2011]. Relationship between pulmonary and systemic markers of exposure to multiple types of welding particulate matter. *Toxicology* 287(1–3):153–159.

### Invited Presentations

- Erdely A [2010]. Systemic markers of pulmonary exposure to nanoparticles. Nanomaterials and Worker Health Conference, Keystone, Colorado, July 21–23.



## Project 27: Cardiovascular Toxicity Assessment of Subchronic Inhalation Exposure to Fullerene C60

**Principal Investigator:** Aaron Erdely, PhD (and Petia Simeonova, PhD, deceased)

**Project Duration:** FY 2009–2010

**Critical Topic Areas:** Toxicology and internal dose

### Accomplishments and Research Findings

- Evaluated cardiovascular effects of subchronic inhalation exposure to fullerene C60 particles (1 and 0.05  $\mu\text{m}$  in diameter) in the mouse and rat (in collaboration with the National Institute of Environmental Health and Safety).
- The initial screening for cardiovascular toxicity demonstrated changes in the expression of several genes related to a stress response, including *c-fos* and heat shock proteins 25, 70, and 90 in the aortas of the exposed mice. A select panel specific for heat shock and associated genes showed an increase in multiple related genes. Further evaluation also showed effects in the heart as well as female and male mice. A dose-dependent effect was evident, and the smaller of the two fullerenes had a greater effect.
- Heat shock proteins are involved in regulating many autoimmune/chronic inflammatory diseases. In this regard, it has been suggested that there is a multifaceted role for heat shock proteins in atherosclerosis. Wild-type mice (not prone to develop atherosclerosis) exposed to fullerenes developed cardiovascular stress responses, which may indicate a predisposition to atherogenesis.
- Interestingly, inhalation exposure to fullerene C60 in rats did not have the same pronounced effect on heat shock protein changes as in the mouse. Instead, inhalation exposure resulted in a significant inflammatory response in the heart and vasculature. Mediators included *Il6*, *Il10*, *Ptgs2* and *Serpine1*.
- These combined results indicate differential effects by species. Despite the differences, the changes overall indicate that prolonged inhalation exposure results in significant alterations in cardiovascular tissue expression profiles, absent of any observable pulmonary effect.

### Publications and Abstracts

- Simeonova PP, Erdely A, Liston A, Luster MI, Roycroft J, Germolec D, Walker NJ [2009]. Potential cardiovascular effects of fullerene C60 inhalation exposure. *Toxicologist* 108(1):50.



## Project 28: Cell-Based Assessment for Iron Nanoparticle–Induced Health Risks

**Principal Investigator:** Yong Qian, PhD

**Project Duration:** FY 2008–2011

**Critical Topic Areas:** Toxicology and internal dose

### Accomplishments and Research Findings

- Developed a cell-based model for assessing iron nanoparticle–induced potential health risks.
- Trained two post-PhD fellows and one PhD graduate student.
- Data from this project provided key preliminary results for a successful Pilot Funding Grant from the Mary Babb Randolph Cancer Center in the Health Sciences Center at West Virginia University.
- Developed a cell-based model for assessing iron nanoparticle–induced potential health risks.
- Identified a possible association between exposure to multi-walled carbon nanotubes (MWCNTs) and lung cancer proliferation and progression. This study indicates that MWCNT exposure may induce the alteration of several key carcinogenesis-related signaling transduction pathways. Taken together, the results obtained from this study suggest potentially carcinogenic effects of MWCNT exposure on human lungs.

### Publications and abstracts

- Apopa PL, Qian Y, Guo NL, Schwegler-Berry D, Pacurari M, Porter D, Shi X, Vallyathan V, Castranova V, Flynn DC [2009]. Iron oxide nanoparticles induce human microvascular endothelial cell permeability through reactive oxygen species production and microtubule remodeling. *Particle Fibre Toxicol* 6:1–14.
- Pacurari M, Qian Y, Porter DW, Wolfarth M, Wan Y, Luo D, Castranova V, Guo NL [2011]. Multi-walled carbon nanotube–induced gene expression in the mouse lung: implication of carcinogenesis risk. *Particle Fibre Toxicol* [submitted].

### Invited Presentations

- Qian Y, Apopa PL, Guo NL, Schwegler-Berry D, Pacurari M, Porter D, Shi X, Vallyathan V, Castranova V, Flynn DC [2010]. Iron oxide nanoparticles induce human microvascular endothelial cell permeability through reactive



oxygen species production and microtubule remodeling. 6th Conference on Molecular Mechanisms of Metal Toxicity and Carcinogenesis, Lexington, Kentucky, November 12–16.

- Apopa PL, Guo NL, Schwegler-Berry D, Pacurari M, Porter D, Shi X, Vallyathan V, Castranova V, Flynn DC, Qian Y [2010]. Iron oxide nanoparticles induce human microvascular endothelial cell permeability through reactive oxygen species production and microtubule remodeling. Annual Society of Toxicology Meeting, Salt Lake City, Utah, March 7–11.
- Pacurari M, Qian Y, Porter DW, Wolfarth M, Wan Y, Luo D, Castranova V, Guo NL [2011]. Multi-walled carbon nanotube–induced gene expression in the mouse lung: implication of carcinogenesis risk. Abstract for 2011 Annual Society of Toxicology Meeting Washington, DC, March 6–10.

## Project 29: Assessment of Carbonaceous Materials on Mutagenicity

**Principal Investigator:** Anna A. Shvedova, PhD, DSc

**Project Duration:** FY 2008–2009

**Critical Topic Areas:** Toxicology and internal dose

### Accomplishments and Research Findings

- Inhalation exposure of C57BL/6 mice (5 mg/m<sup>3</sup>, 5 hours a day, for 4 days) to respirable single-walled carbon nanotubes (SWCNTs) caused formation of anuclear macrophages with fibrillar cytoplasm, along with mitotic changes, in the lung interstitial cells. A pattern of anaphase bridges in macrophages was clearly detected at 7 and 28 days post-inhalation. Therefore, such mitotic changes within macrophages with anaphase bridges indicated feasible spindle aberrations.
- Post-exposure findings at 7 days revealed observable foci of bronchiolar epithelial cell hypertrophy in all exposed mice. Post-exposure findings at 28 days revealed bronchiolar epithelial cell hypertrophy and hyperplasia in all exposed mice.
- Severe oxidative stress observed in the lung of mice exposed to inhalable SWCNTs revealed depletion of GSH, protein thiol oxidation, accumulation of lipid peroxidation products, reduced total antioxidant reserves, and augmentation of 8-hydroxy-2'-deoxyguanosine (8-OHdG), a marker of oxidative DNA damage.
- K-ras mutations were observed in the lung of C57BL/6 mice after inhalation exposure to SWCNTs. The first 2 mutations in DNA samples corresponded to a change in the wild-type K-ras gene codon 12 (GGT, glycine) to AGT (lane 2, serine) and GAT (lane 3, aspartate). The third mutation was a double mutation consisting of a GGT to GAT (glycine to aspartate at codon 12) and a GTG to ATG (valine to methionine at codon 8).
- One of the mutations found in mice exposed to SWCNTs by inhalation route (at day 28 post-exposure) consisted of a double mutation occurring at codons 12 and 8 (GGT to GAT and GTG to ATG [valine to methionine], respectively). The role of this double mutation is unknown and may be specific to SWCNT exposure.

### Publications and Abstracts

- Shvedova AA, Kisin E, Murray AR, Johnson, VJ, Gorerlik O, Arepalli S, Hubbs F, Mercer RR, Keohavong P, Sussman N, Jin J, Yin J, Stone S, Chen BT,



Deye G, Maynard A, Castranova V, Baron PA, Kagan VE [2008]. Inhalation versus aspiration of single walled carbon nanotubes in C57BL/6 mice: inflammation, fibrosis, oxidative stress and mutagenesis. *Am J Physiol Lung Cell Mol Physiol* 295(4):L552– L565.

- Elder A, Lynch I, Grieger K, Chan-Remillard S, Gatti A, Gnewuch H, Kenawy E-R, Korensten R, Kuhlbusch T, Linker F, Matias S, Monteiro-Riviere N, Pinto V, Rudnitsky R, Savolainen K, Shvedova A [2008]. Deposition of nanoparticles as a function of their interactions with biomolecules. In: Linkov & Steevens, eds. *Nanomaterials: risks and benefits. Proceedings of the NATO Advanced Research Workshop on Nanomaterials: Environmental Risks and Benefits*, Faro, Portugal, April 27–30. Amsterdam, The Netherlands: Springer, pp. 3–29.
- Shvedova AA, Kisin ER, Porter D, Schulte P, Kagan VE, Fadeel B, Castranova V [2008]. Mechanisms of pulmonary toxicity and medical applications of carbon nanotubes: two faces of Janus? *Pharmacol Ther* Dec 6, PMID: 19103221.

### Invited Presentations

- Shvedova AA [2008]. Single-walled carbon nanotubes: Are they mutagenic? Mary Babb Randolph Cancer Center–National Institute of Occupational Safety and Health (MBRCC –NIOSH) Scientific Retreat on Cancer, Morgantown, West Virginia, February 12.

## **Project 30: Durability of Nanoscale Cellulose Fibers in Artificial Human Lung Fluids**

**Principle Investigators:** Aleksandr B. Stefaniak, PhD  
and Elizabeth Shogren

**Project Duration:** FY 2011–2012

**Critical Topic Areas:** Toxicology and internal dose; exposure assessment

### **Accomplishments and Research Findings**

- Obtained funding from the National Toxicology Program.
- Recruited four private and public sector organizations in the United States and Canada that donated five materials for planned studies.
- Developed analytical protocols for material characterization and biodurability testing.
- Characterized material physicochemical properties, including hydrodynamic diameter (photon correlation spectroscopy), zeta potential (light scattering), specific surface area (gas adsorption), density (pycnometry), crystallinity (x-ray diffraction), endotoxin and glucan content (LAL assay), and free radical generation (electron spin resonance).
- Attended the TAPPI Workshop on International Standards for Nanocellulose, Arlington, Virginia.
- Member of ISO TC229–Cellulose Task Group, which is drafting the United States’ position on terminology for nanocellulose through TAPPI.

### **Publications and Abstracts**

- None

### **Invited Presentations**

- None



## Project 31: Osteopontin and Carbon Nanotubes

**Principal Investigator:** Petia Simeonova, PhD

**Project Duration:** FY 2004–2009

**Critical Topic Areas:** Toxicology and Internal Dose

### Accomplishments and Research Findings

Respiratory exposure to engineered nanoparticles carries a potential risk for systemic effects including cardiovascular. We demonstrated that respiratory exposure to carbon nanotubes (CNT) induces blood and vascular alterations related to potential adverse cardiovascular outcomes. An interesting finding was that CNT accumulation in the lung after a single exposure is associated with a chronic and persistent release of osteopontin (OPN) into the systemic circulation. The blood release was accompanied by the expression of OPN and several closely related genes in the lung. Our hypothesis is that CNT-exposure induces persistent macrophage activation in the lung which is associated with expression and secretion of OPN. OPN may play a role in the CNT—induced local and cardiovascular responses and represent a biomarker of response.

### Publications and Abstracts

- Erdely A, Hulderman T, Salmen R, Liston A, Zeidler-Erdely P, Simeonova P [2009]. Time course of systemic effects following a single exposure to carbon nanotubes. *Toxicologist* 108(1):279
- Walker V, Hulderman T, Simeonova P [2009]. Mechanism of multiwalled carbon nanotube- and asbestos-induced osteopontin/CD44 in Raw 264 macrophages. *Mol Biol Cell* 12(20 Suppl):2689

### Invited Presentations

None

## Project 32: Determination of Diameter Distribution for Carbon Nanotubes by Raman Spectroscopy

**Principal Investigator:** Madalina Chirila, PhD

**Project Duration:** FY 2007–2009

**Critical Topic Areas:** Measurement methods

### Accomplishments and Research Findings

- Installed digital camera on the microscope of the Raman system.
- Developed procedures for Raman and photoluminescence (PL) analysis of airborne CNT samples deposited on stainless steel grids.
- Performed Raman analyses on a set of 6 CNT samples, using 785 nm excitation to quantify fiber dimensions.
- Performed scanning electron microscopy (SEM) analysis on airborne CNT samples from NYU to quantify dimensions.

### Publications and Abstracts

- Pacurari M, Yin X, Ding M, Leonard S, Schwegler-Berry D, Ducatman B, Chirila M, Endo M, Castranova V, Vallyathan V [2008]. Oxidative and molecular interactions of multi-wall carbon nanotubes (MWCNT) in normal and malignant human mesothelial cells. *Nanotoxicology* 2(3):155–170.
- Stefaniak A, Chirila M [2008]. Tungsten oxide fiber dissolution and persistence in artificial human lung fluids. *Proceedings of the inhalable particles 2009. J Phys Conf Ser* 151 012013 doi:10.1088/1742-6596/151/1/012013
- Kisin E, Murray A, Schwegler-Berry D, Scabilloni J, Mercer R, Chirila M, Young S, Leonard S, Keohavong P, Fadeel B, Kagan V, Castranova V, Shvedova A [2010]. Pulmonary response, oxidative stress and genotoxicity induced by carbon nanofibers. *Toxicologist* 114(1):169.
- Chirila M, Chisholm WP, Harper M [2006]. Raman spectroscopy: A powerful tool for characterizing physical properties and dispersion of single wall carbon nanotubes. *Internat Aerosol Conf* pp:170–171.

### Invited Presentations

- Chirila M [2007]. Assessment of metallic to semiconducting single wall carbon nanotubes ratio from Raman spectroscopy. Pittcon, Chicago, IL, February 26.





## Project 33: Inhalation Facility Support

**Principle Investigator:** Teh-Hsun B. Chen, PhD

**Project Duration:** FY 2000–2015

**Critical Topic Areas:** Toxicology and internal dose

### Accomplishments and Research Findings

#### MWCNT

- Designed and fabricated an exposure chamber for multi-walled carbon nanotube (MWCNT) studies.
- Characterized the MWCNT aerosol in the chamber, including the concentration, particle size distribution, and particle morphology.
- Designed the inhalation exposure, based on the estimation of deposited lung burden of MWCNT aerosol from its size distribution and mass concentration.
- Providing exposed animals for evaluation of cardiovascular effects of MWCNTs.
- Successfully completed a dose-response study.
- Successfully conducted 6 inhalation exposures (each involving 5 hours of exposure per day for 12 days) in the 1-year time-course study. Endpoints to be evaluated include pulmonary, central nervous system, and tumor development.

#### TiO<sub>2</sub> Spray

- Characterized the aerosol resulting from the application of a commercial TiO<sub>2</sub> spray. Results demonstrated the presence of nano-sized TiO<sub>2</sub> particles in the aerosol, with a concentration of 105 particles/cm<sup>3</sup> as the worst-case exposure scenario.
- Designed and fabricated a generation/exposure system for a spray can study. This system uses a computer-controlled solenoid finger aided with an innovative can-shaking device to provide desirable aerosols in a custom-built whole-body chamber. Seven exposures were successfully conducted by exposing Sprague-Dawley rats to different combinations of concentrations (2–4 mg/m<sup>3</sup>) and times (2–16 hours).

#### Welding Fumes

- Fabricated a cone-shaped welding chamber according to physical dimensions recommended by the American Welding Society. This chamber is being used

to evaluate the influence of welding process parameters on fume emission factors, profiles of the individual metals, and biological responses of ultrafine fume particles.

- Observed that modest changes in welding process parameters (e.g., voltage) affected particle size and elemental composition and altered the temporal lung toxicity profile. Results indicated that although welding fume generated at a high voltage (30 kV) produced more nanoparticles, it did not elicit a neurotoxic response, compared to that generated at regular voltage (25 kV). The lack of neurotoxicity may be linked to the reduced solubility of Mn in the high-voltage fumes.
- Constructed an automated resistance spot-welding generation and exposure system.
- Generated fume aerosols of consistent concentrations (1–15 mg/m<sup>3</sup>) in the animal exposure chamber during spot welding. The generated fumes have been characterized in terms of particle size, composition, and morphology. With or without an adhesive, the aerosol consists of both a metal particle and a volatile substance. The metal particle is composed of Fe, Mn, Cr, Zn, and Si. Samples of the volatile chemical have been sent for analyses.

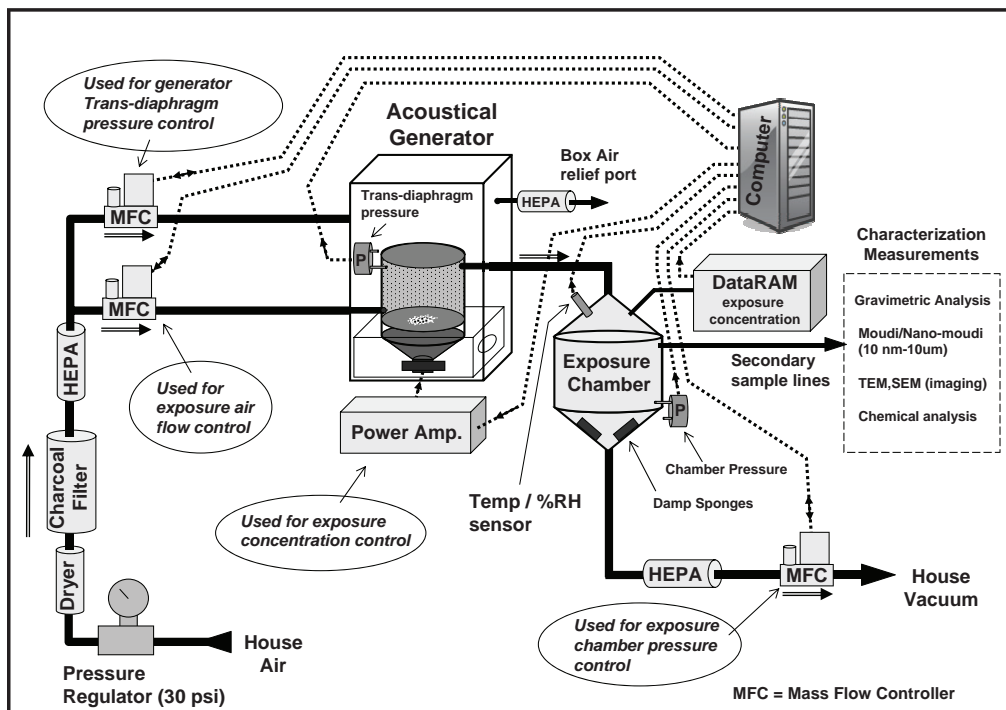

Inhalation Exposure System



## Publications and Abstracts

- Antonini JM, Afshari AA, Stone S, Chen BT, Schwegler-Berry D, Fletcher WG, Goldsmith WT, Vandestouwe KH, McKinney W, Castranova V, Frazer DG [2006]. Design, construction, and characterization of a novel robotic welding fume generation and inhalation exposure system for laboratory animals. *J Occup Environ Hyg* 3:194–203.
- Nurkiewicz TR, Porter DW, Barger M, Hubbs AF, Millecchia L, Rao K, Chen BT, Frazer D, Castranova V, Boegehold MA [2006]. Ultrafine particulate matter inhalation induces remote microvascular dysfunction. *FASEB J* 20(5)(Part 2):A1150.
- Antonini JM, Stone S, Roberts JR, Chen BT, Schwegler-Berry D, Afshari AA, Frazer DG [2007]. Effect of short-term stainless steel welding fume inhalation exposure on lung inflammation, injury, and defense responses in rats. *Toxicol Appl Pharmacol* 223:234–245.
- Nurkiewicz TR, Porter DW, Hubbs AF, Millecchia L, Donlin M, Chen BT, Frazer D, Castranova V [2007]. Nanoparticle inhalation attenuates systemic microvascular endothelium-dependent nitric oxide production. *Microcirculation* 14(4–5): IA-20, 470.
- Nurkiewicz TR, Porter DW, Hubbs AF, Cumpston J, Chen BT, Frazer D, Castranova V [2008]. Nanoparticle inhalation augments particle-dependent systemic microvascular dysfunction. *Particle Fibre Toxicol* 5:1.
- Baron PA, Deye GJ, Chen BT, Schwegler-Berry D, Shvedova AA, Castranova V [2008]. Aerosolization of single-walled carbon nanotubes for an inhalation study. *Inhal Toxicol* 8:751–760.
- Shvedova AA, Kisin E, Murray AR, Johnson V, Gorelik O, Arepalli S, Hubbs AF, Mercer RR, Keohavong P, Sussman N, Jin J, Stone S, Chen BT, Deye G, Maynard A, Castranova V, Baron P, Kagan VE [2008]. Inhalation versus aspiration of single walled carbon nanotubes in C57bl/6 mice: inflammation, fibrosis, oxidative stress and mutagenesis. *Am J Physiol Lung Cell Mol Physiol* 295:L552–L565.
- Antonini JM, Roberts JR, Stone S, Chen BT, Schwegler-Berry D, Frazer DG [2009]. Short-term inhalation exposure to mild steel welding fume had no effect on lung inflammation and injury but did alter defense responses to bacteria in rats. *Inhal Toxicol* 21:182–192.
- Keane M, Stone S, Chen B, Slaven J, Schwegler-Berry D, Antonini J [2009]. Hexavalent chromium content in stainless steel welding fumes is dependent on the welding process and shield gas type. *J Environ Monit* 11:418–424.
- Nurkiewicz TR, Porter DW, Hubbs AF, Stone S, Chen BT, Frazer DG, Boegehold MA, Castranova V [2009]. Pulmonary nanoparticle exposure disrupts systemic microvascular nitric oxide signaling. *Toxicol Sci* 110(1):191–203.

- McKinney W, Chen BT, Frazer D [2009]. Computer controlled multi-walled carbon nanotube inhalation exposure system. *Inhal Toxicol* 21(12):1053–1061.
- LeBlanc AJ, Cumpston JL, Chen BT, Frazer D, Castranova V, Nurkiewicz TR [2009]. Nanoparticle inhalation impairs endothelium-dependent vasodilation in subepicardial arterioles. *J Toxicol Environ Health A* 72:1576–1584.
- Antonini JM, Sriram K, Benkovic SA, Roberts JR, Stone S, Chen BT, Schwegler-Berry D, Jefferson AM, Billig BK, Felton DM, Frazer DG, O'Callaghan JP, Miller DB [2009]. Mild steel welding fume causes manganese accumulation and subtle neuroinflammatory changes but not overt neuronal damage in discrete brain regions of rats after short-term inhalation exposure. *Neurotoxicology* 30:915–925.
- Porter DW, Hubbs AF, Mercer RR, Wu N, Wolfarth MG, Sriram K, Leonard S, Battelli L, Schwegler-Berry D, Friend S, Andrew M, Chen BT, Tsuruoka S, Endo M, Castranova V [2010]. Mouse pulmonary dose- and time course-responses induced by exposure to multi-walled carbon nanotubes. *Toxicology* 269:136–147.
- Keane M, Stone S, Chen BT [2010]. Welding fumes from stainless steel gas metal arc processes contain multiple manganese chemical species. *J Environ Monit* 12:1133–1140.
- LeBlanc AJ, Moseley AM, Chen BT, Frazer D, Castranova V, Nurkiewicz TR [2010]. Nanoparticle inhalation impairs coronary microvascular reactivity via a local reactive oxygen species-dependent mechanism. *Cardiovascular Toxicol* 10:27–36.
- Sriram K, Lin GX, Jefferson AM, Roberts JR, Chapman RS, Chen BT, Soukup JM, Ghio AJ, Antonini JM [2010]. Dopaminergic neurotoxicity following pulmonary exposure to manganese-containing welding fumes. *Arch Toxicol* 84:521–540.
- Scuri M, Chen BT, Castranova V, Reynolds JS, Johnson VJ, Samsell L, Walton C, Piedimonte G [2010]. Effects of titanium dioxide nanoparticles exposure on neuroimmune responses in rat airways. *J Toxicol Environ Health Part A* 73:1353–1369.
- Chen BT, Afshari A, Stone S, Jackson M, Schwegler-Berry D, Frazer DG, Castranova V, Thomas TA [2010]. Nanoparticles-containing, spray can aerosol: characterization, exposure assessment, and generator design. *Inhal Toxicol* 22:1072–1082.
- Wang L, Castranova V, Mishra A, Chen B, Mercer R, Schwegler-Berry D, Rojanasakul Y [2010]. Dispersion of single-walled carbon nanotubes by a natural lung surfactant for pulmonary in vitro and in vivo toxicity studies. *Particle Fibre Toxicol* 7:31.



- Leonard SS, Chen BT, Stone SG, Schwegler-Berry D, Kenyon AJ, Frazer D, Antonini JM [2010]. Comparison of stainless and mild steel welding fumes in generation of reactive oxygen species. *Particle Fibre Toxicol* 7:32.
- Zeidler-Erdely PC, Battelli LA, Stone S, Chen BT, Frazer DG, Young S, Erdely A, Kashon ML, Andrews R, Antonini JM [2011]. Short-term inhalation of stainless steel welding fume causes sustained lung toxicity but no tumorigenesis in lung tumor susceptible A/J mice. *Inhal Toxicol* 23:112–120.
- Roberts JR, Chapman RS, Tirumala V, Karim A, Chen BT, Schwegler-Berry D, Stefaniak AB, Leonard SS, Antonini JM [2011]. Toxicological evaluation of lung responses after intratracheal exposure to non-dispersed titanium dioxide nanorods, *J Toxicol Environ Health Part A* 74:790–810.
- Antonini JM, Roberts JR, Stone S, Chen BT, Schwegler-Berry D, Chapman R, Zeidler-Erdely PC, Andrews RN, Sriram K, Frazer DG [2011]. Persistence of deposited metals in the lungs after stainless steel and mild steel welding fume inhalation in rats. *Arch Toxicol* 85:487–498.
- Erdely AD, Hulderman T, Salmen R, Liston A, Zeidler-Erdely PC, Chen BT, Stone S, Frazer DG, Antonini JM, Simeonova PP [2011]. Inhalation exposure of gas-metal arc stainless steel welding fume increased atherosclerotic lesions in apolipoprotein E knockout mice. *Toxicol Lett* 204:12–16.
- Antonini JM, Keane M, Chen BT, Stone S, Roberts JR, Schwegler-Berry D, Andrews RN, Frazer DG, Sriram K [2011]. Alterations in welding process voltage affect the generation of ultrafine particles, fume composition, and pulmonary toxicity. *Nanotoxicology* 5:700–710.
- LeBouf RF, Stefaniak AB, Chen BT, Frazer DG, Virji MA [2011]. Measurement of airborne nanoparticle surface area using a filter-based gas adsorption method for inhalation toxicology experiments. *Nanotoxicology* 5:687–699.
- Nurkiewicz TR, Porter DW, Hubbs AF, Stone S, Moseley AM, Cumpston JL, Goodwill AG, Frisbee SJ, Perrotta PL, Frisbee JC, Boegehold MA, Frazer DG, Chen BT, Castranova V [2011]. Pulmonary particulate matter and systemic microvascular dysfunction. HEI Research Report No. 164, Boston, MA, December.
- Knuckles TL, Yi J, Frazer DG, Leonard HD, Chen BT, Castranova V, Nurkiewicz TR [2011]. Nanoparticle inhalation alters systemic arteriolar vasoreactivity through sympathetic and cyclooxygenase-mediated pathways. *Nanotoxicology*. Online doi:10.3109/17435390.2011.606926.
- Sellamuthu R, Umbright C, Roberts J+, Chapman R, Young S, Richardson D, Leonard D, McKinney W, Chen B, Frazer D, Li S, Kashon M, Joseph P [2011]. Blood gene expression profiling detects silica exposure and toxicity. *Toxicol Sci* 122(2):253–264.
- Kan H, Wu ZX, Young SH, Chen BT, Cumpston JL, Chen F, Kashon ML, Castranova V [2011]. Pulmonary exposure of rats to ultrafine titanium dioxide enhances

- cardiac protein phosphorylation and substance P synthesis in nodose ganglia. *Nanotoxicology*. Online doi:10.3109/17435390.2011.611915
- LeBouf RF, Ku BK, Chen BT, Frazer DG, Cumpston JL, Stefaniak AB [2011]. Measuring surface area of airborne titanium dioxide powder agglomerates: relationships between gas adsorption, diffusion and mobility-based methods. *J Nanoparticle Res* 13(12):7029–7039.
  - Sellamuthu R, Umbright C, Roberts J, Cumpston A, McKinney W, Chen BT, Frazer D, Li S, Kashon M, Joseph P [2012]. Molecular insights into the progression of crystalline silica-induced pulmonary toxicity in rats. *J Appl Toxicol* [<http://dx.doi.org/10.1002/jat2733>].
  - Mishra A, Rojanasakul Y, Chen BT, Castranova V, Mercer R, Wang L [2012]. Assessment of pulmonary fibrogenic potential of multi-walled carbon nanotubes in human lung cells. *J Nanomater* 3:930931.
  - Erdely AD, Antonini JM, Salmen-Muniz R, Liston A, Hulderman T, Simonova PP, Kashon M, Li S, Stone S, Chen BT, Frazer DG, Zeidler-Erdely PC [2011]. Type I interferon and pattern recognition receptor signaling following particulate matter inhalation. *Particle Fibre Toxicol* [submitted].
  - McKinney W, Jackson M, Sager TM, Reynolds JS, Chen BT, Afshari A, Krajnak K, Waugh S, Johnson C, Mercer RR, Frazer DG, Thomas TA, Castranova V [2012]. Pulmonary and cardiovascular responses of rats to inhalation of a commercial antimicrobial spray containing titanium dioxide nanoparticles. *Inhal Toxicol* 24(7):447–457.
  - Chen BT, Schwegler-Berry D, McKinney W, Stone S, Cumpston JL, Friend S, Porter DW, Castranova V, Frazer DG [2011]. Multi-walled carbon nanotubes aerosols: physical characterization and health relevance. *Inhal Toxicol* [submitted].

### Invited Presentations

- Chen BT, Cumpston JL, Moseley AM, Stone S, Schwegler-Berry D, Porter DW, Hubbs AF, Frazer DG, Castranova V, Nurkiewicz TR [2009]. Particle-associated systemic microvascular dysfunction [abstract #7I.27]. Annual Conference of the American Association for Aerosol Research. Minneapolis, Minnesota, October 26–30.
- Antonini JM, Chen BT, Stone S, Roberts JR, Schwegler-Berry D, Chapman R, Moseley A, Cumpston JL, Leonard H, Frazer DG, Keane M, Sriram K [2010]. Alterations in welding process parameters change particle characteristics and influence lung responses [abstract]. American Thoracic Society International Conference, New Orleans, Louisiana, May 14–19. *Am J Respir Crit Care Med* 181:A1746.
- Chen BT, Afshari A, Stone S, Jackson M, McKinney W, Schwegler-Berry D, Frazer DG, Castranova V, Thomas TA [2010]. Nanoparticle-containing, spray





can aerosol: characterization, exposure assessment, and inhalation chamber design [abstract #2J1]. The 29th Annual Conference of the American Association for Aerosol Research, Portland, Oregon, October 25–29.

- McKinney W, Afshari A, Chen BT, Frazer DG [2010]. Automated aerosolization, dispersion, and concentration control of silica powder for use in inhalation exposure studies [abstract]. Society of Toxicology Annual Meeting, Salt Lake City, Utah, March 7–11. *Toxicologist* 114(1):317.
- Afshari A, Chen BT, Schwegler-Berry D, Cumpston JL, Cumpston A, Leonard HD, Friend S, Zeidler-Erdely PC, Frazer DG, Antonini JM [2011]. Characterization of welding aerosols generated by resistance spot welding. Society of Toxicology Annual Meeting, Washington, DC, March 6–10.
- Erdely A, Hulderman T, Liston AL, Salmen-Muniz R, Stone S, Chen BT, Frazer DG, Li S, Kashon ML, Antonini JM, Simeonova PP, Zeidler-Erdely PC [2011]. Interferon signaling, systemic inflammation and atherosclerosis following welding fume inhalation exposure—from the lung to the blood to the vasculature. Society of Toxicology Annual Meeting, Washington, DC, March 6–10.
- Hubbs AF, Castranova V, Chen BT, Frazer DG, McKinney W, Mercer RR, Kashon ML, Battelli LA, Willard P, Porter DW [2011]. Pulmonary inflammation, epithelial hyperplasia, and lymph node translocation after multi-walled carbon nanotube inhalation. Society of Toxicology Annual Meeting, Washington, DC, March 6–10.
- Kan H, Wu Z, Young S, Chen TB, Cumpston JL, Chen F, Castranova V [2011]. Nanoparticle inhalation enhances cardiac protein phosphorylation and neurotransmitter synthesis in the nodose ganglia of rats. Society of Toxicology Annual Meeting, Washington, DC, March 6–10.
- Knuckles TL, Yi J, Frazer DG, Cumpston JL, Chen BT, Castranova V, Nurkiewicz TR [2011]. Nanoparticles alter cyclooxygenase activity in microvascular dysfunction. Society of Toxicology Annual Meeting, Washington, DC, March 6–10.
- LeBouf RF, Ku BK, Chen BT, Cumpston JL, Stefaniak AB [2011]. Measurement of surface area of airborne titanium dioxide powder agglomerates: relationships between real-time diffusion charging-based and gas adsorption filter-based methods. 5th International Symposium on Nanotechnology, Occupational and Environmental Health, Boston, Massachusetts, August 11–12.
- Roberts JR, Chapman RS, Young SH, Kenyon A, Schwegler-Berry D, Stefaniak AB, Chen BT, Antonini JM [2011]. Pulmonary toxicity following intratracheal instillation of dispersed silver nanoparticles in rats. Society of Toxicology Annual Meeting, Washington, DC, March 6–10.
- Sellamuthu R, Umbright C, Roberts J, Chapman R, Young S, Leonard D, McKinney W, Chen B, Frazer D, Li S, Kashon M, Joseph P [2011]. Peripheral



- blood gene expression profiling reveals silica-induced pulmonary toxicity. Society of Toxicology Annual Meeting, Washington, DC, March 6–10.
- Stapleton PA, Minarchick V, Cumpston A, McKinney W, Chen BT, Frazer D, Castranova V, Nurkiewicz TR [2011]. Time-course of impaired coronary arteriolar endothelium-dependent dilation after multi-walled carbon nanotube inhalation. Society of Toxicology Annual Meeting, Washington, DC, March 6–10.
  - Wolfarth M, McKinney W, Chen TB, Castranova V, Porter DW [2011]. Acute pulmonary responses to MWCNT inhalation. Society of Toxicology Annual Meeting, Washington, DC, March 6–10.



## Project 34: Generation and Characterization of Nanoparticles

**Principal Investigator:** Bon-Ki Ku, PhD

**Project Duration:** FY 2004–2008

**Critical Topic Area:** Measurement methods

### Accomplishments and Research Findings

- Developed an electrospray generation system to produce single-walled carbon nanotube (SWCNT) aerosols with well-defined morphology for the purpose of evaluation of instrument response to different morphology and possibly applying them to in vitro cell culture toxicity tests.
- Field-tested size-selected nanoparticle measurement techniques and sampling methods in workplaces for physical and chemical analysis using transmission electron microscopy.
- Characterized purified SWCNTs generated by electrospraying of suspensions.
- Conducted research on relationships among electrical mobility, mass, and size for nanodrops 1–6.5 nm in diameter.
- Demonstrated that the established relation (which is used in the scanning mobility particle sizer) between electrical mobility and mass diameter for a sphere can be applied with confidence over the whole size range, down to 1.3 nm.
- Investigated relationship between aerodynamic and mobility diameters of SWCNTs and MWCNTs and airborne carbon nanofiber.
- In conjunction with the University of Minnesota, applied a new method to characterize the structure of airborne SWCNTs. The results obtained are expected to be used by toxicologists and other scientists to investigate and identify physical properties that may contribute to observed particle toxicity.
- Observed anomalous behavior in state-of-the-art aerosol instrumentation. This research is expected to lead to the development of effective monitoring methods and new/improved instrument designs that are needed for accurate characterization of worker exposures.
- In conjunction with Yale University, contributed a large number of data on mobility and mass relations for a significant number of different materials in the size range of a few nanometers. The data are valuable in giving a basis for accurate measurements of nanoparticles at very small sizes and are expected to be used in future research.

- Characterized bipolar charging characteristics of carbon nanofibers to better understand particle charging-based instrument response to different particle morphologies, such as spherical and fiber shape.

## Publications and Abstracts

- Maynard AD [2004]. Nanotechnology—a new occupational health challenge for a new generation? *Int Commission Occup Health Newsletter* 2(3):4–6.
- Maynard AD [2004]. Responsible nanotech at work. *Nanotechnology: A Materials Today Supplement*, p. 56.
- Maynard AD, Baron PA, Foley M, Shvedova AA, Kisin ER, Castranova V [2004]. Exposure to carbon nanotube material during the handling of unrefined single walled carbon nanotube material. *J Toxicol Environ Health Part A* 67:87–107.
- Ku BK, Maynard AD [2005]. Comparing aerosol surface-area measurement of monodisperse ultrafine silver agglomerates using mobility analysis, transmission electron microscopy and diffusion charging. *J Aerosol Sci* 36:1108–1124.
- Maynard AD [2005]. Characterizing exposure to nanomaterials. *Toxicologist* 84:A649.
- Maynard AD, Kuempel ED [2005]. Airborne nanostructured particles and occupational health. *J Nanopart Res* 7:587–614.
- Ku BK, Maynard AD [2006]. Generation and investigation of airborne silver nanoparticles with specific size and morphology by homogeneous nucleation, coagulation, and sintering. *J Aerosol Sci* 37:452–470.
- Ku BK, Emery MS, Maynard AD, Stolzenburg MR, McMurry PH [2006]. In situ structure characterization of airborne carbon nanofibers by a tandem mobility-mass analysis. *Nanotechnology* 17:3613–3621.
- Peters TM, Heitbrink WA, Evans DE, Slavin TJ, Maynard AD [2006]. The mapping of fine and ultrafine particle concentrations in an engine machining and assembly facility. *Ann Occup Hyg* 50(3):249–257.
- Maynard AD, Ku B-K, Emery M, Stolzenburg M, McMurry P [2007]. Airborne single-walled carbon nanotube agglomerates show particle size-dependent physicochemical structure. *J Nanopart Res* 9:85–92.
- Ku B-K, Maynard AD, Baron PA, Deye G [2007]. Observation and measurement of anomalous responses in a differential mobility analyzer by ultrafine fibrous carbon aerosols. *J Electrostat* 65:542–548.
- Ku B-K [2008]. Nanomaterials and occupational health [in Korean]. *Indust Health* 2:44–49.
- Ku B-K, Fernandez de la Mora J [2009]. Relation between electrical mobility, mass, and size for nanodrops 1–6.5 nm in diameter in air. *Aerosol Sci Technol* 43(3), 241–249.



- Shvedova AA, Kisin E, Murray AR, Johnson V, Gorelik O, Arepalli S, Hubbs AF, Mercer RR, Keohavong P, Sussman N, Jin J, Yin J, Stone S, Chen BT, Deye G, Maynard A, Castranova V, Baron PA, Kagan VE [2008]. Inhalation versus aspiration of single-walled carbon nanotubes in C57BL/6 mice: inflammation, fibrosis, oxidative stress, and mutagenesis. *Am J Physiol Lung Cell Mol Physiol* 295(4):L552–L565.
- Ku B-K, Kulkarni P [2009]. Morphology of single-wall carbon nanotube aggregates generated by electrospray of aqueous suspensions. *J Nanopart Res* 11(6):1393–1403.

### Invited Presentations

- Ku BK, Maynard AD, Evans DE [2005]. Methods for measuring the active surface area of ultrafine particles as an exposure metric. 9th International Symposium on Neurobehavioral Methods and Effects in Occupational and Environmental Health, Gyeongju, South Korea, September 26–29.
- Evans DE, Maynard AD, Peters TM, Heitbrink WA [2005]. Estimating aerosol surface area in the automotive industry. 24th Annual AAAR Conference, Austin, Texas, October 17–21.
- Ku BK, Maynard AD [2005]. Physical characterization of airborne carbon nanofibers. In: Proceedings of the 2nd International Symposium on Nanotechnology and Occupational Health, Minneapolis, Minnesota, October 3–6, p. 119.
- Ku BK, Maynard AD, Baron PA, Deye G [2005]. Anomalous responses (arcing, electrical discharge) in a differential mobility analyzer caused by ultrafine fibrous carbon aerosols. In: Proceedings of the 24th Annual AAAR Conference, Austin, Texas, October 17–21, p. 43.
- Ramsey D, Ku BK, Maynard AD, Evans DE, Bennett J [2005]. Evaluation of nanoparticle de-agglomeration by disc centrifuge. In: Proceedings of the 2nd International Symposium on Nanotechnology and Occupational Health, Minneapolis, Minnesota, October 3–6, p. 120.
- Stolzenburg M, McMurry PH, Emery MS, Ku BK, Maynard AD [2006]. Obtaining dispersion of an intensive particle property from a tandem-sizing experiment. 7th International Aerosol Conference, Minneapolis, Minnesota, September 10–15.
- Ku BK, Emery MS, Maynard AD, Stolzenburg MR, McMurry PH [2006]. Measurement of airborne carbon nanofiber structure using a tandem mobility-mass analysis. 7th International Aerosol Conference, Minneapolis, Minnesota, September 10–15.
- Ku B-K [2007]. Characterization of purified single-walled carbon nanotube aerosols generated by electrospraying of suspension. International Symposium on Nanotechnology, Occupational, and Environmental Health. Taipei, Taiwan, August 29–September 1.

- Ku B-K, Fernandez de la Mora J, Ude S [2007]. Relation between electrical mobility, mass, and size in the nanometer range of charged nanoparticles generated by electrosprays. American Association for Aerosol Research Annual Conference, Reno, Nevada, September 24–28.
- Ku B-K [2007]. Nanoparticles and Occupational Health: Toward Safe Nanotechnology Conference. University of Kentucky, Lexington, Kentucky, April 24.
- Ku B-K [2007]. Nanoparticles, Occupational and Environmental Health: Physical Characterization of Nanoparticles Conference. Korea Institute of Machinery and Materials, Daejeon, Korea, September 3 and 4.
- Ku B-K [2007]. Contemporary Issues in Occupational Health: Nanoparticles and Occupational Health Conference. University of Yonsei, Seoul, Korea, September 5.
- Ku B-K, Fernandez de la Mora J [2008]. Electrical mobility, mass, and size for nanodrops 1–3.5 nm in diameter. American Association for Aerosol Research Annual Conference, Orlando, Florida, October 20–24.
- Kulkarni P, Deye GJ, Ku B-K, Baron PA [2008]. Relationship between aerodynamic and mobility diameters of single- and multi-walled carbon nanotube aerosols. American Association for Aerosol Research Annual Conference, Orlando, Florida, October 20–24.



## Project 35: Dustiness of Nanomaterials

**Principle Investigator:** Douglas E. Evans, PhD

**Project Duration:** FY 2007–2010

**Critical Topic Areas:** Measurement methods; exposure assessment; fire and explosion safety

### Accomplishments and Research Findings

- Completed pilot phase of the research.
- Evaluated novel method/device for testing pharmaceutical powders and found it to be suitable for testing nanomaterials. Advantages of the method include
  - Only small powder samples required (mg quantities), allowing for a potentially greater number of powdered materials to be tested
  - Complete enclosure of the test system, so that the operator is not exposed to potentially toxic materials
  - Relevance to the workplace
  - Simple (gravimetric) size selective sampling of dispersed powders

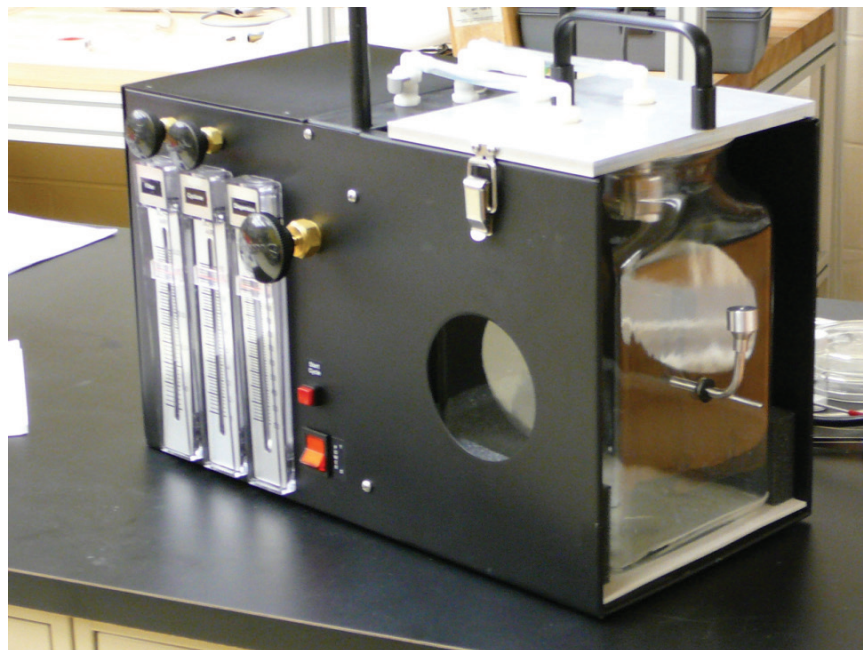

Dustiness testing

- Tested 27 fine and nanoscale materials—consisting of at least five replicate tests—for total and respirable mass. Dustiness values span two orders of magnitude on both a respirable and total mass basis.
- Strong positive correlation between respirable and total mass observed for powders tested.
- Size distribution measurements of powders conducted.
- Other metrics considered, such as particle number.
- Interest in method/research expressed by U.S. EPA.

### Publications and Abstracts

- Evans DE, Turkevich LA, Roettgers CT, Deye GJ, Baron PA [2012]. Dustiness of fine and nanoscale powders. *Ann Occup Hyg*, doi 10.1093/annhyg/mes060.

### Invited Presentations

- Evans DE [2007]. Working at the nanoscale: the occupational health and safety perspective. NANOMIST final meeting, Birmingham, United Kingdom, February 19.
- Evans DE [2007]. Working at the nanoscale: the occupational health and safety perspective. Health and Safety Laboratory, Buxton, United Kingdom, February 20.
- Mark D, Bard D, Wake D, Hoover MD, Stefaniak AB, Methner MM, Evans DE, Geraci CL [2008]. Problems and experience of measuring worker exposure to engineered nanoparticles. International Inhalation Symposium: Benefits and Risks of Inhaled Engineered Nanoparticles. Hanover, Germany, June 11–14.
- Evans DE [2010]. Workplace monitoring during CNF production. Ask the Expert: An Update on the NIOSH Nanotechnology Program. The American Industrial Hygiene Conference and Exposition, Denver, Colorado, May 25.
- Evans DE, Turkevich LA, Roettgers C, Deye GJ, Baron PA [2011]. Dustiness of nanomaterials. AIHce, Portland, Oregon, May 14–19.
- Evans DE, Turkevich LA, Roettgers C, Deye GJ, Baron PA [2011]. Dustiness of nanomaterials. 5th International Symposium on Nanotechnology–Occupational and Environmental Health, Boston, Massachusetts, August 10–12.
- Evans DE, Turkevich LA, Roettgers C, Deye GJ, Baron PA [2011]. Dustiness of nanomaterials. American Association for Aerosol Research Annual Conference, Orlando, Florida, October 3–7.





## Project 36: Measurement of Nanoscale Carbonaceous Aerosols

**Principle Investigator:** M. Eileen Birch, PhD

**Project Duration:** FY 2007–2008 (Continued in FY09 as project 37)

**Critical Topic Areas:** Measurement methods, exposure assessment

### Accomplishments and Research Findings

- Completed preliminary investigations at two carbon nanofiber (CNF) facilities when this project began in June 2007. A NIOSH Health Hazard Evaluation (HHE) report on the first field study was published in 2006. A report on the second study was sent to the company in 2007.
- Completed design and assembly of a mobile, aerosol sampling unit (cart) for performing real-time aerosol measurements in workplaces. The unit is equipped with sampling ports and battery power and accommodates a laptop and multiple aerosol instruments.
- Completed in-depth field study (five site visits during FY2007 and FY2008) at a major CNF manufacturer. Found CNF dispersion within the facility. Identified production byproducts and informed company regarding air quality. Also provided recommendations to improve air quality.
- Began work on generation of a carbon black aerosol and its collection on filter sets (FY08). Work continued in FY2009 under project 37.
- Participated in the American Ceramics Society Workshop, Nanoparticle Measurement Needs for Environmental Health and Safety, in Arlington, Virginia, June 9 and 10, 2008.

### Publications and Abstracts

- Methner MM, Birch ME, Evans DE, Ku B-K, Crouch KG, Hoover MD [2007]. Case study: identification and characterization of potential sources of worker exposure to carbon nanofibers during polymer composite laboratory operations. *J Occup Environ Hyg* 4(12):D125–D130.
- Noll J, Birch ME [2008]. Effects of sampling artifacts on occupational samples of diesel particulate matter. *Environ Sci Technol* 42(14):5223–5228.
- Kulkarni P, Deye G, Baron P [2008]. Bipolar diffusion charging of carbon nanotube aerosols. *J Aerosol Sci* doi:10.1016/j.jaerosci.2008.09.008.

- Wang Z, Hopke PK, Ahamadi G, Cheng Y-S, Baron PA [2008]. Fibrous particle deposition in human and nasal passage: the influence of particle length, flow rate, and geometry of nasal airway. *J Aerosol Sci* 39(12):1040–1054.

### Invited Presentations

- Birch ME, Evans DE, Ku B-K [2007]. Occupational monitoring of carbonaceous nanomaterials. American Association for Aerosol Research Annual Conference, Reno, Nevada, September 24–28.
- Evans DE, Birch ME, Ku B-K, Ruda-Eberenz T [2008]. Occupational monitoring of carbonaceous nanomaterials. American Association for Aerosol Research Annual Conference, Orlando, Florida, October 20–24.
- Ruda-Eberenz T, Birch ME, Evans DE, Ku B-K [2008]. Occupational monitoring of carbonaceous nanomaterials. Central Regional Meeting of the American Chemical Society, Columbus, Ohio, June 10–14.



## **Project 37: Nanoaerosol Monitoring Methods (formerly Automotive Ultrafine Intervention)**

**Principle Investigators:** M. Eileen Birch, PhD, and  
Douglas E. Evans, PhD

**Project Duration:** FY 2006–2012

**Critical Topic Areas:** Measurement methods, exposure assessment

### **Accomplishments and Research Findings**

This project was initiated as an umbrella project of the aerosol research team in the NIOSH Division of Applied Research and Technology (DART). It has supported multiple pilot investigations on fine/ultrafine and nanomaterial aerosols. Project objectives are to evaluate monitoring methods for nanoscale aerosols and to characterize aerosol properties. Filter-based methods and state-of-the-art instruments have been applied. Metrics include particle mass, surface area, number, size distribution, composition, and morphology. Significant activities included the following:

- Conducted first Institute study (FY06) at a carbon nanofiber (CNF) composite facility (University of Dayton Research Institute [UDRI]). This first Institute study on engineered nanomaterials inspired creation of a NIOSH nanotechnology field team for screening surveys.
- Collaborated on collection and analysis of diesel particulate samples from mines.
- Contributed technical input to multiple other nano surveys (e.g., quantum dots, filter manufacturer).
- Completed walk-through and screening surveys at a major CNF producer. Provided summary of results and submitted report to company.
- Completed survey on ultrafine aerosol sources at diesel engine manufacturing plant.
- Provided direct-reading instrument data collected at titanium dioxide manufacturing facility to an environmental health and safety facilitator.
- Completed construction of a novel instrument for fast measurement of nanoparticle size distribution (instrument has been developed as a commercial prototype under a new project).
- Conducted initial survey of firefighters' exposures during vehicle fire suppression training exercises (three engine and three cabin fires) (July 2009). Coauthored HHE report (2010).

- Monitored fine/ultrafine particles during structural fire training exercise at the Illinois Fire Service Institute, with the Chicago Fire Department (three structural fires in 08/10 and three structural fires in 08/11).
- Co-authored (Evans) small NORA proposal (with DSHEFS) on exposures to firefighters during structural fire suppression. Proposal was funded. Preliminary findings suggest that self-contained breathing apparatus (SCBA) should be worn throughout all stages of fire suppression.
- Completed pilot studies on direct-reading instrument for determining the elemental composition of aerosols.
- Submitted new NORA proposal on development of a direct-reading instrument for elemental composition of aerosol; proposal was approved (2QFY12) for funding.
- Established partnerships for research translation (e.g., Photon Machines, Inc., BGI Inc. are partners on a new FY12 NORA project; Kanomax, Inc. is a partner on commercialization of a portable aerosol monitor).
- Collaborated on rail yard study of worker exposure to diesel emissions.

### Publications and Abstracts

- Liang F, Lu M, Birch ME, Keener TC, Liu Z [2006]. Determination of polycyclic aromatic sulfur heterocycles in diesel particulate matter and diesel fuel by gas chromatography with atomic emission detection. *J Chromatogr A* 1114(1):145–153.
- Methner M, Birch ME, Evans D, Hoover M [2006]. NIOSH Health Hazard Evaluation (HHE) on workplace assessment of potential exposure to carbonaceous nanomaterials, HETA Report #2005-0291-3025.
- Heitbrink WA, Evans DE, Peters TM, Slavin TJ [2007]. Characterization and mapping of very fine particles in an engine machining and assembly facility. *J Occup Environ Hyg* 4(5):341–351.
- Baron PA, Estill CF, Beard JK, Hein MJ, Larsen L [2007]. Bacterial endospore inactivation caused by outgassing of vaporous hydrogen peroxide from polymethyl methacrylate (Plexiglas®). *Lett Appl Microbiol* 45:485–490.
- Wang Z, Hopke PK, Ahamadi G, Cheng Y-S, Baron PA [2008]. Fibrous particle deposition in human and nasal passage: the influence of particle length, flow rate, and geometry of nasal airway. *J Aerosol Sci* 39(12):1040–1054.
- Baron P, Deye GJ, Martinez AB, Jones EN, Bennett JS [2008]. Size shifts in measurements of droplets with the aerodynamic particle sizer and the aerosizer. *Aerosol Sci Technol* 42(3):201–209.
- Olfert J, Kulkarni P, Wang J [2008]. Rapid measurements of aerosol size distributions using a fast integrated mobility spectrometer. *J Aerosol Sci* [www.ecd.bnl.gov/pubs/BNL-79289-2007-AB.pdf].



- Evans DE, Heitbrink WA, Slavin TJ, Peters TM [2008]. Ultrafine and respirable particles in an automotive grey iron foundry. *Ann Occup Hyg* 52(1):9–21.
- Baron PA, Estill CF, Deye GJ, Hein MJ, Beard JK, Larsen LD, Dahlstrom GE [2008]. Development of an aerosol system for uniformly depositing bacillus anthracis spore particles on surfaces. *Aerosol Sci Technol* 42(3):159–172.
- Shvedova AA, Kisin E, Murray AR, Johnson V, Gorelik O, Arepalli S, Hubbs AF, Mercer RR, Stone S, Frazer D, Chen T, Deye G, Maynard A, Baron P, Mason R, Kadiiska M, Stadler K, Mouithys-Mickalad A, Castranova V, Kagan VE [2008]. Inhalation of carbon nanotubes induces oxidative stress and cytokine response causing respiratory impairment and pulmonary fibrosis in mice. *Toxicologist* 102(1):307.
- Baron PA, Deye GJ, Chen B, Schwegler-Berry DE, Shvedova AA, Castranova V [2008]. Aerosolization of single-walled carbon nanotubes for an inhalation study. *Inhal Toxicol* 20(8):751–760.
- Shvedova AA, Kisin E, Murray AR, Johnson V, Gorelik O, Arepalli S, Hubbs AF, Mercer RR, Keohavong P, Sussman N, Jin J, Stone S, Chen BT, Deye G, Maynard A, Castranova V, Baron PA, Kagan VE [2008]. Inhalation versus aspiration of single-walled carbon nanotubes in C57BL/6 mice: inflammation, fibrosis, oxidative stress, and mutagenesis. *Am J Physiol* 95(4):L552–L565.
- Heitbrink WA, Evans DE, Ku B-K, Maynard AD, Slavin TJ, Peters TM [2009]. Relationships between particle number, surface area, and respirable mass concentration in automotive engine manufacturing. *J Occup Environ Hyg* 6(1):19–32.
- Kulkarni PK, Deye GJ, Baron PA [2009]. Bipolar diffusion charging characteristics of single-walled carbon nanotube aerosols. *J Aerosol Sci* 40(2):164–179.
- Fent KW, Evans DE [2011]. Assessing the risk to firefighters from chemical vapors and gases during vehicle fire suppression. *J Environ Monit* 13(3):536–543.
- Fent KW, Evans DE, Couch J [2010]. Evaluation of chemical and particle exposures during vehicle fire suppression training: Health Hazard Evaluation Report, HETA 2008-0241-3113, Miami Township Fire and Rescue, Yellow Springs, Ohio (July 2010).
- Fent KW, Evans DE, Couch J, Niemeier M [2012]. Evaluating vehicle fire training inhalation hazards. *Fire Engineering* 165(2): 63–68.
- Diwakar PK, Kulkarni PS, Birch ME [2012]. New approach for near-real-time measurement of elemental composition of aerosols using laser induced breakdown spectroscopy. *Aerosol Science and Technology* 46:316–332.
- Diwakar PK, Kulkarni PS [2012]. Measurement of elemental concentration of aerosols using spark emission spectroscopy. *Journal of Analytical Atomic Spectrometry*, doi: 10.1039/C2JA30025G

## Invited Presentations

- Evans DE [2006]. Field measurement of aerosols at the nanoscale. International Conference for Nanotechnology. Occupational and Environmental Health and Safety; Research to Practice. Cincinnati, Ohio, December 7th.
- Dunn KH [2006]. Nanotech exposure controls and best practices. International Conference for Nanotechnology. Occupational and Environmental Health and Safety; Research to Practice. Cincinnati, Ohio, December 7th.
- Birch ME, Evans DE, Methner M, McCleery RE, Crouch KG, Ku B-K, Hoover MD [2006]. Workplace assessment of potential exposure to carbonaceous nanomaterials, International Conference for Nanotechnology. Occupational and Environmental Health and Safety; Research to Practice, Cincinnati, Ohio, December 7th.
- Kulkarni P, Wang J [2006]. High-time resolution measurement of nanoaerosol size distribution using fast integrated mobility spectrometer (FIMS) [2006]. International Conference for Nanotechnology. Occupational and Environmental Health and Safety; Research to Practice. Cincinnati, Ohio, December 7th.
- Liang F, Birch ME, Lu M [2006]. Load dependent composition of diesel particulate emissions from a non-road diesel generator, International Conference for Nanotechnology. Occupational and Environmental Health and Safety; Research to Practice. Cincinnati, Ohio, December 7th.
- Baron PA [2006]. Description of an aerosol calculator. 7th International Aerosol Conference, Minneapolis, Minnesota, September 10–15.
- Birch ME, Evans DE, Methner MM, McCleery RE, Crouch KG, Ku B-K, Hoover MD [2006]. Workplace assessment of potential exposure to carbonaceous nanomaterials. International Aerosol Conference, St. Paul, Minnesota, September 10–15.
- Birch ME, Evans DE, Ku B-K [2007]. Occupational monitoring of carbonaceous nanomaterials. American Association for Aerosol Research Annual Conference, Reno, Nevada, September 24–28.
- Heitbrink WA, Evans DE, Ku B-K, Maynard AD, Peters TM, Slavin TJ [2007]. The relationship between particle surface area, number, and respirable mass concentration in an automotive foundry and engine machining facility. American Association for Aerosol Research Annual Conference, Reno, Nevada, September 24–28.
- Kulkarni PK, Deye GJ, Baron PA [2007]. Bipolar diffusion charging characteristics of airborne, single-walled carbon nanotubes. American Association for Aerosol Research Annual Conference, Reno, Nevada, September 24–28.
- Evans DE [2007]. Working at the nanoscale: the occupational health and safety perspective. NANOMIST Meeting, Birmingham, United Kingdom, February 19.



- Baron PA [2008]. Aerosol science enabling nanomaterial research: experience in environmental and occupational health. Inaugural Meeting of the Student Chapter of American Association for Aerosol Research, University of Cincinnati, Cincinnati, Ohio, April 29.
- Diwakar P, Kulkarni PS, Birch ME [2010]. Matrix effect in substrate based laser-induced breakdown spectroscopy. 6th International Conference on Laser-Induced Breakdown Spectroscopy (LIBS 2010), Memphis, TN, Sep 13–17.
- Diwakar P, Kulkarni PS, Birch ME [2010]. Novel approach for analysis of fine and ultra-fine aerosol particles using laser induced breakdown spectroscopy. 6th International Conference on Laser-Induced Breakdown Spectroscopy 2010 (LIBS 2010), Memphis, TN, Sep 13–17.
- Diwakar P, Kulkarni PS, Birch ME [2010]. Matrix effects in laser-induced breakdown spectroscopy. 29th American Association for Aerosol Research Annual Conference, Portland, OR, October 25–29.
- Diwakar P, Kulkarni PS, Birch ME [2010]. Semi-continuous measurement of elemental composition of aerosol particles using laser induced breakdown spectroscopy. 29th American Association for Aerosol Research Annual Conference, Portland, OR, October 25–29.
- Lu M, Hu JC, Birch ME, Yang J, Keener T, Wei H [2011]. Measurement of near-road black carbon exposure from traffic sources in a midwestern urban area, NORA Symposium 2011: Achieving Impact through Research and Partnerships. Cincinnati, OH, July 12–13.
- Diwakar P, Kulkarni P, Birch E [2011]. Novel approach for analysis of fine and ultra-fine aerosol particles using laser induced breakdown spectroscopy. NORA Symposium 2011: Achieving Impact through Research and Partnerships, Cincinnati, OH, July 12–13
- Diwakar P, Kulkarni P [2011]. Spark-induced breakdown spectroscopy for near real-time elemental analysis of aerosols. 3rd North American Symposium on Laser-Induced Breakdown Spectroscopy, (NASLIBS), Clearwater Beach, FL, July 18–20.
- Diwakar P, Kulkarni P, Efthimion P [2011]. Corona-assisted microwave plasma spectroscopy (CAMPS) for aerosol analysis. 3rd North American Symposium on Laser Induced Breakdown Spectroscopy (NASLIBS 2011), Clearwater Beach, FL, July 18–20.
- Cauda E, Miller A, Ku BK, Barone T [2011]. Surface area of diesel particulate matter nanoparticles in underground mines. 5th International Conference on Nanotechnology—Occupational and Environmental Health, Boston, MA, August 9–12.
- Diwakar P, Kulkarni PS [2011]. Near real-time elemental analysis of aerosols using spark-induced breakdown spectroscopy. AAAR 30th Annual Conference, Orlando, FL, October 3–7.



- Diwakar P, Hahn DW, Niemax K, Groh S [2011]. Role of analyte diffusion in laser-induced plasmas. FACSS 2011, Reno, NV, Oct 2–7.
- Diwakar P, Kulkarni PS [2011]. Near real-time elemental analysis of aerosols using laser and spark-induced breakdown spectroscopy. FACSS 2011, Reno, NV, October 2–7.



## Project 38: Workplace Monitoring of Carbon Nanofibers/Nanotubes

**Principle Investigators:** M. Eileen Birch, PhD, and Douglas E. Evans, PhD

**Project Duration:** FY 2009–2012

**Critical Topic Areas:** Measurement methods, exposure assessment

### Accomplishments and Research Findings

#### Field/Laboratory Research

- Conducted follow-up survey at CNF manufacturer and submitted report to company (FY09).
- Conducted two surveys with the Division of Surveillance and Hazard Evaluations collaborators: at a multi-walled CNT [MWCNT] and SWCNT manufacturer and at a SWCNT and fullerene manufacturer (FY10)
  - Completed sample analyses (NIOSH 5040). Performed direct-reading monitoring, analyzed data, and co-authored two company reports. Provided recommendations to companies to reduce potential exposures.
- Conducted survey at single-walled CNT (SWCNT) manufacturer in OK (FY10).
  - Found surface contamination by SWCNTs and catalyst precursor. Completed sample analyses (NIOSH 5040) and reported to manufacturer.
- Developed aerosol generation method to collect matched filter sets with known organic and elemental carbon (OC and EC).
- Completed international round robin on OC-EC filter sets; completed journal paper on results.
- Characterized over 20 CNF/CNT materials chemically and physically. Properties were quite variable—e.g., specific surface areas ranged from 22 to 662 m<sup>2</sup>/g, with a material (Mitsui) tested in an inhalation study by NIOSH Health Effects Research Division (HELD) being the lowest (manuscript submitted).
- Designed modified air sampler to improve NIOSH 5040 LOD for respirable aerosol.
- Completed sampler comparison (FY11–FY12).
- Began investigation of a method for determining the metal content of CNTs/CNFs.

- Completed additional surface area (BET) measurements on CNF/CNT materials.
- Completed TGA analyses of CNF/CNT materials (FY11).
- Initiated research on a TEM-based method for counting CNT/CNF structures.
- Collaborated on field studies with IWSB colleagues.
  - Doug Evans participated in two exposure assessment surveys with DSHEFS/IWSB colleagues. Assessments consisted of personal breathing zone and area monitoring with time-integrated and direct-reading methods.
  - Dr. Birch reviewed TEM and NIOSH 5040 results for six field surveys by IWSB (and others) to assist with data interpretation and quality.

### Other

- Reviewed and responded to public and peer reviewers' comments on draft CNT/CNF CIB.
- Established MOA with University of Cincinnati (UC) regarding sharing of the NIOSH TEM facility in exchange for technical assistance with TEM analyses and UC contribution to the instrument maintenance contract.



Nanoparticle sampling equipment



- Reviewed multiple Laboratory Information Management System (LIMS) reports on TEM results (FY11–12).
- Established IA on carbonaceous aerosols with U.S. EPA.
- Established MOA with University of Cincinnati (UC) regarding NIOSH transmission electron microscopy (TEM) facility. (FY11–12)
- Coauthored NTP proposal on CNF/CNT exposure assessment with DSHEFS colleagues (funded in FY12–FY13). Evans et al. [2010] journal article on work-place monitoring of CNFs by direct reading instruments won the NIOSH 2011 Alice Hamilton Award in the Engineering and Physical Sciences category.

### Publications and Abstracts

- Evans DE, Ku BK, Birch ME, Dunn KH [2010]. Aerosol monitoring during carbon nanofiber production: mobile direct-reading sampling. *Ann Occup Hyg* 54(5):514–531.
- Birch ME [2010]. Appendix C: NIOSH method 5040, and exposure monitoring section. NIOSH current intelligence bulletin: occupational exposure to carbon nanotubes and nanofibers (draft). NIOSH docket number: NIOSH 161-A [[www.cdc.gov/niosh/docket/review/docket161A/](http://www.cdc.gov/niosh/docket/review/docket161A/)].
- Birch ME, Ku BK, Evans DE, Ruda-Eberenz T [2011]. Exposure and emissions monitoring during carbon nanofiber production. Part I: elemental carbon and iron-soot aerosols. *Ann Occup Hyg* 55(9):1016–1036.
- Birch ME [2011]. Exposure and emissions monitoring during carbon nanofiber production. Part II: polycyclic aromatic hydrocarbons. *Ann Occup Hyg* 55(9):1037–47.
- Gurumurthy R, Ostraat M, Evans DE, Methner MM, O’Shaughnessy P, D’Arcy J, Geraci C, Stevenson E, Maynard A [2011]. A strategy for assessing workplace exposures to nanomaterials. *J Occup Environ Hyg* 8:673–685.
- He X, Young S-H, Berry DS, Chisholm WP, Fernback JE, Ma Q [2011]. Multiwalled carbon nanotubes induce a fibrogenic response by stimulating reactive oxygen species production, activating NF- $\kappa$ B signaling, and promoting fibroblast-to-myofibroblast transformation. *Chem Res Toxicol* dx.doi.org/10.1021/tx200351d.
- He X, Young S-H, Fernback JE, Ma Q [2012]. Single-walled carbon nanotubes induce fibrogenic effect by disturbing mitochondrial oxidative stress and activating NF-B signaling. *J Clin Toxicol* doi:10.4172/2161-0495.S5-005.
- Chai M, Birch ME, Deye G [2012]. Organic and elemental carbon filter sets: preparation method and interlaboratory results. *Ann Occup Hyg* doi: 10.1093/annhyg/mes029.

- Dahm MM, Evans DE, Schubauer-Berigan MK, Birch ME, Fernback JE [2012]. Occupational exposure assessment in carbon nanotube and nanofiber primary and secondary manufacturers. *Ann Occup Hyg* 56(5):542–556.
- Ruda-Eberenz TA, Birch ME [2012]. Specific surface areas of commercially produced carbon nanomaterials. *Ann Occup Hyg* (submitted).

### Invited Presentations

- Evans DE, Ku B-K, Birch ME, Dunn KH [2009]. Airborne contaminants in a carbon nanofiber manufacturing facility: direct reading monitoring. Poster presentation at the American Association for Aerosol Research (AAAR) 28th Annual Conference, Minneapolis, Minnesota, October 26–30.
- Birch ME, Evans DE, Ku B-K, Ruda-Eberenz T [2009]. Air contaminants in a carbon nanofiber manufacturing facility. Poster presentation at the American Association for Aerosol Research (AAAR) 28th Annual Conference, Minneapolis, Minnesota, October 26–30.
- Birch ME, Evans DE, Ku B-K, Ruda-Eberenz T [2009]. Air contaminants in a carbon nanofiber manufacturing facility. The 4th International Conference on Nanotechnology–Occupational and Environmental Health (NanOE2009), Helsinki, Finland, August 26–29.
- Evans DE, Ku B-K, Birch ME, Dunn KH [2009]. Direct reading monitoring of contaminants in a carbon nanofiber manufacturing facility. The 4th International Conference on Nanotechnology–Occupational and Environmental Health (NanOE2009), Helsinki, Finland, August 26–29.
- Evans DE [2010]. Workplace monitoring during CNF production. Ask the expert: an update on the niosh nanotechnology program. The American Industrial Hygiene Conference and Exposition, Denver, Colorado, May 25.
- Birch ME [2010]. Overview of aerosol research on engineered nanomaterials. Invited seminar sponsored by the Center for Sustainable Urban Environments, University of Cincinnati, Cincinnati, Ohio, February 26.
- Evans DE, Birch ME, Ku B-K, Dunn K, Ruda-Eberenz T [2010]. Emissions and exposure monitoring during carbon nanofiber production. The American Industrial Hygiene Conference and Exposition, Denver, Colorado, May 22–27.
- Agnew RA, Lu M, Birch ME [2010]. Investigation of health relevant physical and chemical properties of select engineered carbon nanotubes. Presented at the American Chemical Society (ACS) National Meeting and Exposition, Boston, Massachusetts, August 22–26.
- Birch ME, Ku B-K, Evans DE, Ruda-Eberenz T [2010]. Exposure and emissions monitoring during carbon nanofiber production. NIOSH Intramural Science Conference (Salt Fork), Cambridge, Ohio, August 9–11.



- Evans DE, Birch ME, Ku B-K, Dunn K, Turkevich L [2010]. Differentiating workplace aerosol emissions by direct-reading instrumentation. International Conference on Workplace Aerosols, Karlsruhe, Germany, June 28–July 2.
- Agnew RA, Lu, M, Birch ME, Hu J [2010]. Characterization and size distribution of engineered carbon nanomaterials. 2010 OIS Conference, Materials and Energy: Building Blocks for Ohio's Economic Future, Columbus, Ohio, April 20–21.
- Evans DE, Turkevich LA, Roettgers C, Deye GJ, Baron PA [2011]. Dustiness of nanomaterials. AIHce, Portland, Oregon, May 14–19.
- Birch ME, Ku BK, Evans DE [2011]. Monitoring mixed exposure during carbon nanofiber production. 5th International Conference on Nanotechnology–Occupational and Environmental Health, Boston, Massachusetts, August 10–12.
- Chai M, Birch ME, Deye G [2011]. Organic and elemental carbon filter sets: preparation method and interlaboratory results. 5th International Conference on Nanotechnology–Occupational and Environmental Health, Boston, Massachusetts, August 10–12.
- Lu M, Hu J, Birch ME, Yang J, Keener T, Wei H [2011]. Measurement of near-road black carbon exposure from traffic sources in a midwestern urban area. NORA Symposium 2011: Achieving Impact through Research and Partnerships, Cincinnati, Ohio, July 12–13.

## Project 39: Real-time Instrument for Nanoaerosol Exposure Measurement

**Principle Investigator:** Pramod Kulkarni, DSc

**Project Duration:** FY 2008–2011

**Critical Topic Areas:** Measurement methods, exposure assessment

### Accomplishments and Research Findings

- Development of first prototype of Portable Aerosol Mobility Spectrometer (PAMS).
- Design and testing of miniature bipolar charger.
- Design of miniature differential mobility analyzer with extended size range and improved resolution.
- Design of miniature condensation particle counter.
- Development of second prototype of PAMS in collaboration with Kanomax Inc.
- Design and testing of prototype of personal nanoaerosol sizer (PNS).

### Publications and Abstracts

- Lin L, Chen DR, Qi C, Kulkarni P [2009]. A miniature disk electrostatic aerosol classifier for personal nanoparticle sizers. *J Aerosol Sci* 40:982–992.
- Qi C, Kulkarni P [2012]. Unipolar charging based hand-held mobility spectrometer for aerosol size distribution measurement. *J Aerosol Science* 49 (0):32–47. doi:10.1016/j.jaerosci.2012.02.005
- Diwakar P, Kulkarni P, Birch ME [2011]. New approach for near-real-time measurement of elemental composition of aerosol using laser-induced breakdown spectroscopy. *Aerosol Science and Technology* 46:316–332.
- Diwakar P, Kulkarni P [2012]. Measurement of Elemental Concentration of Aerosols Using Spark Emission Spectroscopy, *J Analytical and Atomic Spectrometry*, DOI: 10.1039/C2JA30025G.

### Patents and Inventions

- Kulkarni P, Diwakar P, “Method for focused electrostatic collection of aerosol particles for chemical analysis by spectroscopic techniques”, US Patent application #13315372.
- Kulkarni P, Qi C, “Non-radioactive, Miniature Bipolar Charger for Aerosols”, US Patent application #13315344.





- Kulkarni P, Efthimion P, Diwakar P. Method for spectrochemical analysis of aerosols using microwave plasma spectroscopy, CDC Employee Invention Report #I-013-12, patent application pending.
- Kulkarni P, Qi C. Low-flow, wide-range differential mobility analyzer for personal mobility instrumentation, CDC Employee Invention Report #I-010-12.

### Invited Presentations

- Qi C, Kulkarni P, Chen DR [2009]. Development of a portable aerosol spectrometer (PAS) for nanoaerosol exposure measurement. 28th AAAR Conference, Minneapolis, Minnesota, October 26–30.
- Qi C, Kulkarni P [2009]. New miniature unipolar corona charger for personal aerosol instrumentation. 28th AAAR Conference, Minneapolis, Minnesota, October 26–30.
- Lin L, Chen DR, Qi C, Kulkarni P [2009]. A miniature disk electrostatic aerosol classifier for personal nanoparticle sizers. 28th AAAR Conference, Minneapolis, Minnesota, October 26–30.
- Ku BK, Kulkarni P [2010]. Comparison of different approaches for measuring aerosol surface area in the submicrometer size range. NIOSH Intramural Science Conference (Salt Fork), Cambridge, OH, August 10–11.
- Ku BK, Kulkarni P [2010]. Comparison of different approaches for measurement of surface area of nanoaerosols. The AAAR Conference, Portland, OR, October 25–29.
- Diwakar P, Kulkarni P, Birch ME [2010]. Semi-continuous measurement of elemental composition of aerosol particles using laser induced breakdown spectroscopy. 29th Annual AAAR Conference, Portland, OR, October 25–29.
- Diwakar P, Kulkarni P, Birch ME [2010]. Matrix effects in laser-induced breakdown spectroscopy. 29th Annual AAAR Conference, Portland, OR, October 25–29.
- Qi C, Kulkarni P [2010] Personal nanoparticle spectrometer for nanoaerosol exposure measurement. 29th AAAR Annual Conference, Portland, OR, October 25–29.
- Diwakar P, Kulkarni P, Birch ME [2010]. Novel approach for analysis of fine and ultra-fine aerosol particles using laser induced breakdown spectroscopy. 6th International Conference on Laser-Induced Breakdown Spectroscopy, Memphis, TN, September 13–17.
- Diwakar P, Kulkarni P, Birch ME [2010]. Matrix effect in substrate based laser-induced breakdown spectroscopy. 6th International Conference on Laser-Induced Breakdown Spectroscopy, Memphis, TN, September 13–17.

- Diwakar P, Kulkarni P, [2011]. Near Real-time Elemental Analysis of Aerosols Using Laser and Spark-induced Breakdown Spectroscopy. FACSS 2011, Reno, NV, October 2–6.
- Diwakar P, Kulkarni P, [2011]. Near Real-time Elemental Analysis of Aerosols Using Spark-induced Breakdown Spectroscopy. 30th Annual AAAR Conference, Orlando, FL, October 3–7.
- Diwakar P, Kulkarni P, Efthimion P, [2011]. Corona-Assisted Microwave Plasma Spectroscopy [CAMPS] for Aerosol Analysis. 3rd North American Symposium on LIBS, Clearwater, FL, July 18–20.
- Diwakar P, Kulkarni P, [2011]. Spark-Induced Breakdown Spectroscopy for Near Real-Time Elemental Analysis of Aerosols. 3rd North American Symposium on LIBS, Clearwater, FL, July 18–20.
- Qi C, Kulkarni P, [2011]. A Miniature, Non-radioactive Bipolar Charger for Electrical Charging of Aerosols. [2011] 30th AAAR Annual Conference, Orlando, FL, October 3–7.
- Qi C, Kulkarni P, Kato T, Fukushima N, [2011]. Development of Portable Aerosol Electrical Mobility Spectrometer (PAEMS) for Aerosol Exposure Measurement. 30th AAAR Annual Conference, Orlando, FL, October 3–7.
- Qi C, Kulkarni P, [2011]. Development of a Portable Aerosol Mobility Spectrometer (PAMS) for Nanoaerosol Exposure Measurement. Symposium on Nanotechnology—Health and Safety Issues, Cincinnati, OH, May 10.



## Project 40: Nanoparticle Reference Materials for Health Protection

**Principle Investigator:** Aleksandr B. Stefaniak, PhD

**Project Duration:** FY 2007–2009

**Critical Topic Area:** Measurement methods

### Accomplishments and Research Findings

- Participated in NIST-sponsored Workshop on Nanomaterial Manufacturing in Gaithersburg, Maryland, May 2008.
  - Participated in breakout session on separation and fractionation of nanomaterials.
  - Reported output of workshop to the National Nanotechnology Initiative.
- Participated in the American Ceramics Society Workshop on Nanoparticle Measurement Needs for Environmental Health and Safety, Arlington, Virginia, June 2008.
- Co-sponsored with American National Standards Institute, National Cancer Institute, and NIST the Workshop on Enabling Standards for Nanomaterial Characterization, Gaithersburg, Maryland, October 2008.
  - Co-leader of breakout session—Reference and test materials, media and sample preparation.
- Expanded project to become an international collaborative effort and obtained funding for the new project through the NIOSH NTRC (see Project 39).

### Publications and Abstracts

- None

### Invited Presentations

- Stefaniak AB, Schwegler-Berry D, Hoover MD, Goia DV, Rossner A, Postek MT, Poster DL [2007]. Development of nanoparticle size and surface area reference materials for exposure assessment. International Symposium on Occupational Health Implications of Nanomaterials, Taipei, Taiwan, August 31.
- Mark D, Bard D, Wake D, Hoover MD, Stefaniak AB, Methner MM, Evans DE, Geraci CL [2008]. Problems and experience of measuring worker exposure to engineered nanoparticles. International Inhalation Symposium: Benefits and Risks of Inhaled Engineered Nanoparticles. Hanover, Germany, June 11–15.

- Stefaniak AB [2008]. Methodological challenges of assessing bioavailability of emerging contaminants. University of North Carolina Superfund Basic Research Program Workshop: Assessing Bioavailability as a Determinant of Pollutant Exposure: Building a Multidisciplinary Paradigm for the 21st Century and Beyond, Tampa, Florida, February 19–21.
- Stefaniak AB [2008]. Standards Needs for Occupational Exposure Assessment of Nanomaterials. National Institute of Standards and Technology Workshop on Enabling Standards for Nanomaterial Characterization, Gaithersburg, Tennessee, October 19.
- Stefaniak AB (presented by Hoover MD) [2008]. Minimal material characterization of nanomaterials. Workshop on Ensuring Appropriate Material Characterization in Nanotoxicity Studies, Washington, DC, October 10.



## Project 41: International Coordination of Nanoscale Reference Materials

**Principle Investigator:** Aleksandr B. Stefaniak, PhD

**Project Duration:** FY 2010–2012

**Critical Topic Area:** Measurement methods

### Accomplishments and Research Findings

- Successfully developed Division-funded project (project 40) into competitively funded project through NIOSH NTRC.
- Traveled to Cincinnati, OH, for the NTRC Nano Exposure Assessment Working Group meeting and presented data and concepts related to nanoparticle measurement and participated in strategy development.
- Participated as a NIOSH representative to U.S. Technical Advisory Group to International Organization for Standardization Committee 229: Nanotechnologies.
  - Participated in teleconferences and contributed to development of new U.S. work items presented at meeting in Johannesburg, South Africa.
  - Use of electron microscopy to determine primary particle size
  - Measurement methods matrix
- Organization for Economic Cooperation and Development (OECD)
  - Provided expert input and content to revision of Guide 24: Preliminary Guidance Note on Sample Preparation and Dosimetry for the Safety Testing of Manufactured Nanomaterials.
  - Provided expert review of the report Techniques and Sampling Protocols for Determining the Concentrations of Manufactured Nanomaterials in Air.
- Recruited an international working group consisting of health and safety professionals and metrology experts from North America, Asia, and Europe.
- Reviewed existing literature and identified lists of nanoscale materials and characteristics of interest for developing into reference materials. Manuscript undergoing Institutional review.
- Collaborated with the U.S. National Institute of Standards and Technology on development of Standard Reference Material 1898: TiO<sub>2</sub> nanopowder. Manuscript in preparation.
  - Co-developed protocol and helped to organize inter-laboratory studies (ILS) of nanopowder specific surface area.

- Recruited 17 laboratories to participate in ILS.
- Measured powder surface area and density for reference material
- Collaborated with the National Research Council Canada on development of Reference Material NCC-1: NanoCrystalline Cellulose and Reference Material NCCS-1: 6% Aqueous Suspension of NanoCrystalline Cellulose.
  - Contributed measurements of:
    - Hydrodynamic diameter (photon correlation spectroscopy)
    - Zeta potential (light scattering)
    - Specific surface area (gas adsorption)
    - Density (pycnometry)
    - Crystallinity (x-ray diffraction)
    - Endotoxin and glucan content (LAL assay)
- Collaborating with the National Research Council Canada on development of Reference Material 2LV-BIO-SWCNTS: Single-walled carbon nanotubes.

## Publications and Abstracts

- None

## Invited Presentations

- Stefaniak AB, Hackley VA, Patri A, Postek MT [2009]. Nanoscale reference materials for environmental, health and safety applications. 4th International Conference on Nanotechnology–Occupational and Environmental Health, Helsinki, Finland, August 26–28.
- Stefaniak AB, Lawrence RB [2009]. Morphology specifications for dimensional analysis of engineered nano-objects. 4th International Conference on Nanotechnology–Occupational and Environmental Health, Helsinki, Finland, August 26–28.
- Stefaniak AB [2009]. Approaches to measurement of airborne engineered nano-objects. Nanoparticle Air Monitoring Workshop, Research Triangle Park, North Carolina, March 2.
- Stefaniak AB [2010]. International coordination of nanoscale reference materials for environmental health and safety measurement applications. Pacificchem 2010, Honolulu, Hawaii, December 16.
- Stefaniak AB [2011]. What materials and properties are needed for nanoscale reference materials for environmental, health, and safety measurements? 5th International Conference on Nanotechnology—Occupational and Environmental Health, Boston, Massachusetts, August 10–12.



## **Project 42: A Standard Method for Determining Airborne Nanoparticle Size**

**Principle Investigator:** Aleksandr B. Stefaniak, PhD

**Project Duration:** FY 2009–2011

**Critical Topic Areas:** Measurement methods, exposure assessment

### **Accomplishments and Research Findings**

- Formed collaboration with a microscopy supply company and developed a protocol for an inter-laboratory study of a sample preparation method using functionalized grids and NIST nanoparticle reference materials 8011, 8012, and 8013: Gold Nanoparticles.
- Recruited six laboratories (academic, private sector, government) to participate in a series of inter-laboratory studies to evaluate the sample preparation and analysis protocols.
- Piloted sample preparation and analysis protocols with four laboratories.
- Study materials sent out for first inter-laboratory study (to be completed in 2012).
- Developing ASTM International standard on sample preparation for transmission electron microscopy through committee E56: Nanotechnology.

### **Publications and Abstracts**

- None

### **Invited Presentations**

- None



## **Project 43: Calm Air Chamber and Wind Tunnel Evaluation of Personal Aerosol Samplers for Nanoparticle Exposure Assessment**

**Principal Investigator:** Terri Pearce, PhD

**Project Duration:** FY 2008–2010

**Critical Topic Area:** Measurement methods

### **Accomplishments and Research Findings**

- Developed study protocol.
- Obtained external peer-review for protocol.

### **Publications and Abstracts**

- None

### **Invited Presentation**

- Pearce T [2008]. Direct-reading nanoaerosol instrument comparison. Abstract and poster for the American Association for Aerosol Research Annual Conference, Orlando, Florida, October 20–24.



Chamber evaluating direct reading instruments



## **Project 44: Efficacy of NIOSH Method 0600 for Fine and Ultrafine Titanium Dioxide**

**Principle Investigator:** Terri Pearce, PhD

**Project Duration:** FY 2010–2011

**Critical Topic Area:** Measurement methods

### **Accomplishments and Research Findings**

- Completed collection efficiency evaluations for six different types of personal samplers using surrogate nanoaerosol (sodium fluorescein particles with count mean diameter of 40 nanometers).
- Designed a feedback-controlled aerosol generation system for fine and ultra-fine titanium dioxide aerosols.
- Utilized the results from the preliminary testing to choose three sampler types for further collection efficiency evaluations using titanium dioxide aerosols.

### **Publications and Abstracts**

- None

### **Invited Presentations**

- None

## Project 45: Ultrafine TiO<sub>2</sub> Surface and Mass Concentration Sampling Method

**Principle Investigators:** Aleksandr B. Stefaniak, PhD,  
and Ryan F. LeBouf, PhD

**Project Duration:** FY 2007–2011

**Critical Topic Area:** Measurement methods

### Accomplishments and Research Findings

- Characterized bulk powder physicochemical properties (density, morphology, primary particle size, particle cluster size, total surface area by gas adsorption, purity, and crystallinity).
- Developed a protocol for determining background surface area of blank filter media using krypton gas isotherms.
- Developed protocol for measuring TiO<sub>2</sub> mass and surface area in animal inhalation chambers.
- Performed collaborative chamber studies using TiO<sub>2</sub> powder.
- Successfully balloted an ASTM International draft standard through subcommittee E56.02–‘Standard Test Method for Measurement of Airborne Metal and Metal Oxide Nanoparticle Surface Area in Inhalation Exposure Chambers using Gas Adsorption.’ Standard scheduled for committee and society level balloting in 2012.

### Publications and Abstracts

- LeBouf RF, Stefaniak AB, Chen BT, Frazer DG, Virji MA [2011]. Measurement of airborne nanoparticle surface area using a filter-based gas adsorption method following inhalation toxicology experiments. *Nanotoxicology* 5:687–699.
- Roberts JR, Chapman RS, Tirumala V, Karim A, Chen BT, Schwegler-Berry D, Stefaniak AB, Leonard SS, Antonini JM [2011]. Toxicological evaluation of lung responses after intratracheal exposure to non-dispersed titanium dioxide nanorods. *J Toxicol Environ Health A* 74:790–810.
- LeBouf RF, Ku BK, Chen BT, Stefaniak AB [2011]. Measuring surface area of airborne titanium dioxide powder agglomerates: relationships between gas adsorption, diffusion and mobility-based methods. *J Nanoparticle Res* 13:7029–7039.



## Invited Presentations

- Stefaniak AB, Sbarra DC, Duling MG, LeBouf RF, Virji MA [2009]. Measurement of airborne ultrafine  $\text{TiO}_2$  mass and surface area from a single filter sample. 4th International Conference on Nanotechnology–Occupational and Environmental Health, Helsinki, Finland, August 26–29.
- Stefaniak AB [2011]. Measuring nanomaterials in the real world. ILSI NanoRelease Steering Committee Workshop, Arlington, Virginia, May 10–11.
- LeBouf RF, Ku BK, Chen BT, Cumpston JL, Stefaniak AB [2011]. Measurement of surface area of airborne titanium dioxide powder agglomerates: relationships among total, active and mobility-based methods. 5th International Conference on Nanotechnology–Occupational and Environmental Health, Boston, Massachusetts, August 10–12.
- Roberts JR, Chapman RS, Young SH, Kenyon A, Schwegler-Berry D, Stefaniak AB, Chen BT, Antonini JM [2011]. Pulmonary toxicity following intratracheal instillation of dispersed silver nanoparticles in rats. Society of Toxicology, Washington, DC, March 6–10.

## Project 46: Development and Evaluation of Nanoaerosol Surface Area Measurement Methods

**Principal Investigator:** Bon-Ki Ku, PhD

**Project Duration:** FY 2009–2010

**Critical Topic Areas:** Measurement methods, exposure assessment

### Accomplishments and Research Findings

- Characterized aerosol surface area measurement methods in the submicron size range.
- Compared different diffusion charging-based sensors using different types of agglomerates such as silver, PSL, and wax. LQ1-DC (Matter Eng), DC2000CE (EcoChem), and NSAM (TSI Inc) were tested. The diffusion charger responses were also compared with the following methods for estimating aerosol surface area.
  - Surface area estimation from agglomerate particle mass and primary particle size
  - Surface area estimation based on particle mobility diameter
  - Surface area estimation based on mobility diameter of a chain aggregate with uniform primary particle size
- The response of the three diffusion charging-based sensors to silver agglomerates were similar but substantially underestimated the geometric surface area by a factor of 3–10 in the size range studied.
- Surface area estimated by the mobility-based approach decreases compared to the true geometric surface area as particle structure becomes compact, indicating that the mobility-based surface area strongly depends on the particle structure.
- Caution should be exercised in the interpretation of measurements from diffusion charging-based semi-empirical instruments.
- The mobility diameter-based surface area measurements may be relatively accurate for open and moderate agglomerates compared to the diffusion chargers, but they may not be accurate for highly compact agglomerates.
- Investigated aerosol surface area estimated from number and mass concentration measurements (referred to as Maynard estimation method) to quantitatively investigate the effect of actual particle density on the Maynard's estimation method.



- The methods developed and evaluated for measuring aerosol surface area have been used by other researchers from inside and outside NIOSH for exposure assessment of nanoaerosols.
  - University of Iowa for surface area measurement of incidental nanoparticles
  - NIOSH Pittsburgh Research Laboratory (PRL) for surface area measurement of diesel particulate matter (DPM)
  - NIOSH Morgantown Division of Respiratory Disease Studies (DRDS) for surface area measurement of airborne fine and ultrafine TiO<sub>2</sub>
- Collaborated with University of Iowa, NIOSH Pittsburgh Research Laboratory, and NIOSH Morgantown Division of Respiratory Disease Studies.

### Publications and Abstracts

- Ku BK [2010]. Determination of the ratio of diffusion charging-based surface area to geometric surface area for spherical particles in the size range of 100–900 nm. *J Aerosol Sci* 41:835–847.
- Ku BK, Deye GJ, Kulkarni P, Baron PA [2011]. Bipolar diffusion charging of high-aspect ratio aerosols. *J Electrostat* 69(6):641–647.
- Ku BK, Kulkarni P [2012]. Comparison of diffusion charging and mobility-based methods for measurement of aerosol agglomerate surface area. *J Aerosol Sci* DOI: 10.1016/j.jaerosci.2012.01.002.
- Ku BK, Evans DE [2012]. Investigation of aerosol surface area estimation from number and mass concentration measurements: particle density effect. *Aerosol Sci Technol* 46(4):473–484.
- Cena LG, Ku BK, Peters TM [2012]. Particle collection efficiency for nylon mesh screens. *Aerosol Sci Technol* 46(2):214–221.

### Invited Presentations

- Ku BK [2009]. Diffusion charger-based aerosol surface-area monitor response to airborne spherical particles 100–800 nm in diameter. The 4th International Conference on Nanotechnology–Occupational and Environmental Health (NanOEH2009), Helsinki, Finland, August 26–29.
- Ku BK, Maynard AD, Evans DE [2009]. Surface-area estimation of polydisperse nanoparticles with controlled morphologies: diffusion charging method and estimates from number and mass concentrations. The 4th International Conference on Nanotechnology–Occupational and Environmental Health (NanOEH2009), Helsinki, Finland, August 26–29.
- Ku BK, Kulkarni P [2010]. Comparison of different approaches for measurement of surface area of nanoaerosols. The AAAR Conference, Portland, Oregon, October 25–29.

- Ku BK, Evans DE [2011]. The effect of particle density on aerosol surface area estimation from number and mass concentration measurements. The 5th International Conference on Nanotechnology–Occupational and Environmental Health, Boston, Massachusetts, August 10–12.





## Project 47: Respiratory Deposition of Airborne Carbon Nanotubes

**Principle Investigators:** Pramod Kulkarni, PhD, and Bon-Ki Ku, PhD

**Project Duration:** FY 2010–2012

**Critical Topic Areas:** Measurement methods, risk assessment

### Accomplishments and Research Findings

This project has made progress in meeting the original objectives and has been extended to include different types of nanomaterials such as silver nanowire, graphene, and fullerene (C60), which are of many interests in nanotechnology. The following objectives were stated in the project proposal:

- Generate SWCNTs and MWCNT aerosols, using a variety of methods to span a range of morphologies of workplace aerosols (FY10–11).
- Perform laboratory measurements on these CNT aerosols to characterize their diffusional and aerodynamic diameter, effective density, and dynamic shape factor (FY11).
- Develop an approach that uses these measurements to estimate size-dependent lung deposition fraction of SWCNTs and MWCNT aerosol particles, using a Multiple Path Particle Dosimetry (MPPD) model (FY11–12).
- Generated SWCNTs and MWCNT aerosols, using a variety of methods to span a range of morphologies of workplace aerosols.
- Designed a laboratory setup on these CNT aerosols to characterize their diffusional and aerodynamic diameter, effective density, and dynamic shape factor.
- Laboratory experiments have been conducted to measure diffusion and aerodynamic diameters of airborne nanotube and nanomaterial aerosols that were generated using different techniques. Tandem mobility-mass measurements were made on nanomaterial aerosols generated by liquid atomization, electrospray, and dry dispersion techniques. The nanomaterials studied in the project are as follows:
  - Single-walled carbon nanotubes
  - Multi-walled carbon nanotubes (MWCNTs-OH with short length)
  - Gas-phase MWCNTs (10–20 nm in tube diameter)
  - Liquid-phase MWCNTs (10–20 nm in tube diameter)
  - Gas-phase MWCNTs (60–100 nm in tube diameter)
  - Silver nanowires

- Graphene nanoparticles
- Fullerene (C60)
- Measured aerodynamic and diffusion diameters of SWCNT aerosols.
- Measured aerodynamic and diffusion diameters of different types of engineered nanomaterials mentioned above.
- Characterized particle morphology for different nanomaterials using Transmission Electron Microscopy (TEM).
- Correlations from these measurements were used as an input to spherical particle dosimetry model to probe relative difference in SWCNT and MWCNT aerosol deposition with respect to spherical particle deposition.
- Collaborators on this project include Eileen Kuempel (NIOSH/EID) and Lovelace Respiratory Research Institute, Albuquerque, NM.

### **Publications and Abstracts**

- Ku BK, Deye GJ, Kulkarni P, Baron PA [2011]. Bipolar diffusion charging of high-aspect ratio aerosols. *J Electrostat* 69(6):641–647.

### **Invited Presentations**

- None



## **Project 48: Exposure Potential From Use of Nanomaterial-Enabled Consumer Products**

**Principle Investigator:** Aleksandr B. Stefaniak, PhD

**Project Duration:** FY 2009–2012

**Critical Topic Areas:** Measurement methods, exposure assessment

### **Accomplishments and Research Findings**

- Obtained 18 commercially available products (textiles, cleaning products, medical products, paints, personal hygiene, electronics, and sporting goods) that claim to contain nanosilver.
- Coordinated with U.S. Environmental Protection Agency and National Institute of Standards and Technology to devise analytical approaches to determine whether the products contain silver and, if so, whether it is nanoscale.
- Characterized the amount and form of silver in 10 products, using ICP, UV-Vis, and electron microscopy.
- Performing release studies for textiles in contact with artificial skin fluids (sweat, sebum)

### **Publications and Abstracts**

- None

### **Invited Presentations**

- None

## Project 49: Ultrafine Aerosols from Diesel-Powered Equipment

**Principal Investigator:** Aleksandar Bugarski, PhD

**Project Duration:** FY 2004–2008

**Critical Topic Area:** Measurement methods

### Accomplishments and Research Findings

- Evaluated the effects of a fuel-borne, catalyst-regenerated, sintered metal, diesel-particulate-filter (DPF) system from Mann-Hummel on size distribution and concentration of nano and ultrafine aerosols in mine air. This study, conducted at NIOSH Diesel Laboratory at Lake Lynn Laboratory, was used to characterize physical and chemical properties of aerosols emitted from an engine equipped with a sintered metal DPF system and to assess the effects of DPF regeneration strategy (fuel-borne catalyst) on concentrations of aerosols and gases in mine air.
- Evaluated potential of biodiesel fuels to reduce concentrations of aerosols in mine air. Compared neat and blended biodiesel fuels with ultra low sulfur petroleum diesel relating to their effects on the concentrations and size distributions of diesel aerosols in underground mine conditions. The physical and chemical properties and toxicity of diesel and biodiesel aerosols in mine air were studied.
- Evaluated the effects of an electrically regenerated, sintered metal DPF system from Rypos on size distribution and concentration of nano- and ultrafine aerosols in mine air. This study was used to characterize physical and chemical properties of aerosols emitted from an engine equipped with sintered metal DPF system and to assess the effects of DPF-regeneration strategy (electrical current) on concentrations of aerosols and gases in mine air.
- Developed novel methodology for collection of diesel particulates for genotoxicity analysis. The samples are collected directly on lung surfactant by means of biosamplers and a versatile aerosol concentration enrichment system developed in cooperation with University of Southern California.
- Developed the novel methodology for preparing and analyzing samples collected by using aforementioned sampling system.
- Using the salmonella reversion assays, assessed genotoxic potential of the solvent extracted diesel aerosols samples collected during DPF and biodiesel studies.
- Evaluated suitability of various aerosol instrumentation, such as fast mobility particle sizer, scanning mobility particle sizer, electrical low pressure impactor,



nanoparticle surface area monitor, PAS2000, and filter-sampling methodologies for measurement and sampling of diesel aerosols.

- Completed the new engine/dynamometer system with a Mercedes-Benz engine and 400 kW dynamometer.

## Publications

- Bugarski AD, Schnakenberg GH Jr., Hummer JA, Cauda E, Janisko SJ, Patts LD [2009]. Effects of diesel exhaust aftertreatment devices on concentrations and size distribution of aerosols in underground mine air. *Environmental Science and Technology* 43:6737–6743.
- Shi X-C, Keane MJ, Ong T, Li S-Q, Bugarski AD [2010]. Mutagenicity of diesel exhaust particles from an engine with differing exhaust after treatments. *J Toxicol Environ Health, Part A* 73(19):1314–1324.
- Shi X-C, Keane MJ, Ong TM, Bugarski AD, Gautam M, Wallace WE [2009]. Diesel exhaust particulate material expression of in vitro genotoxic activities when dispersed into a phospholipid component of lung surfactant. *Journal of Physics: Conference Series* 151:1–10.
- Cauda EG, Bugarski A, Mischler SE [2010]. A review of the effects of exhaust aftertreatment on nitrogen dioxide emissions from underground mining equipment. *Mining Engineering* November:60–64.
- Bugarski AD, Cauda E, Janisko SJ, Hummer JA, Patts LD [2010]. Aerosols emitted in underground mine air by diesel engine fueled with biodiesel. *Journal of Air and Waste Management Association* 60:237–244.
- Bugarski AD, Schnakenberg GH Jr., Hummer JA, Cauda E, Janisko SJ, Patts LD [2011]. Evaluation of high-temperature disposable filter elements in an experimental underground mine. *Society for Mining, Metallurgy, and Exploration Transactions* 330:373–382.

## Invited Presentations

- Bugarski A, Schnakenberg GH Jr, Mischler S, Cauda E [2007]. Characterization of the physical and chemical properties of diesel aerosols in an underground mine diesel laboratory. *ETH Conference on Combustion-Generated Nanoparticles*, Zurich, Switzerland, August 13–15.
- Gautam M, Wilt G, Carder D, Bugarski A [2007]. Evaluation of diesel exhaust particulate matter in a ventilated mine tunnel. *ETH Conference on Combustion-Generated Nanoparticles*, Zurich, Switzerland, August 13–15.
- Bugarski AD, Cauda E, Janisko S, Patts LD, Hummer JA, Mischler SE [2008]. Effects of biodiesel on aerosols in underground mine. *Annual Mining Diesel Emissions Conference*, Richmond Hill/Toronto, Ontario, Canada, October 5–10.

- Bugarski AD, Cauda E, Janisko S, Patts LD, Hummer JA, Mischler SE [2008]. Evaluation of an electrically regenerated sintered metal diesel particulate filter system in underground mine laboratory. Annual Mining Diesel Emissions Conference, Richmond Hill/Toronto, Ontario, Canada, October 5–10.
- Shi X-C, Keane MJ, Ong T-M, Bugarski AD, Gautam M, Wallace WE [2008]. Diesel exhaust particulate material expression of in vitro genotoxic activities when dispersed into a phospholipid component of lung surfactant. Inhaled Particles X conference, Sheffield, United Kingdom, September 23–25.
- Bugarski AD, Schnakenberg GH Jr, Cauda E [2008]. Effects of sintered metal diesel particulate filter system on diesel aerosols and nitric oxides in mine air. United States/North American Mine Ventilation Symposium, Reno, Nevada, June 9–11.
- Bugarski A [2008]. Diesel particulate filtration technology in underground mines. California Air Resource Board (CARB)/Southern California Air Quality Management District, course on ultrafine particles and retrofit technologies for diesel engines, Diamond Bar, California, November 12–14.
- C Bugarski A, Schnakenberg GH, Cauda E [2008]. Effects Of Sintered Metal Diesel Particulate Filter System On Diesel Aerosols and Nitric Oxides In Mine Air. Proceeding of 12th United States/North American Mine Ventilation Symposium, Reno, NV, June 9–11.
- Shi X-C, Keane MJ, Ong T-M, Bugarski AD, Gautam M, Wallace WE [2008]. Diesel exhaust particulate material expression of in vitro genotoxic activities when dispersed into a phospholipid component of lung surfactant. Inhaled Particles X Conference, Sheffield, UK, September 23–25.
- Cauda E, Bugarski AD, Mischler SE [2008]. NO<sub>2</sub> Emissions from Diesel Engine Powered Vehicles, 14th Annual Mining Diesel Emissions Conference (MDEC), Richmond Hill/Toronto, Ontario, Canada, October 5–10.
- Bugarski AD, Cauda E, Janisko S, Patts LD, Hummer JA, Mischler SE [2008]. Evaluation of an electrically regenerated sintered metal diesel particulate filter system in underground mine laboratory. 14th Annual Mining Diesel Emissions Conference (MDEC), Richmond Hill/Toronto, Ontario, Canada, October 5–10.
- Bugarski AD, Cauda E, Janisko S, Patts LD, Hummer JA, Mischler SE [2008]. Biodiesel and nano and ultrafine aerosols in underground mine. 14th Annual Mining Diesel Emissions Conference (MDEC), Richmond Hill/Toronto, Ontario, Canada, October 5–10.
- Bugarski AD, Hoover M [2009]. Metric for Exposure Monitoring, Hazard Assessment, and Risk Management for Diesel Aerosols in Underground Mines. Poster at 13th ETH Conference on Combustion Generated Nanoparticles, Zürich, Switzerland, June 22–24, ISBN 978-3-033-01994-2.



- Bugarski AD, Shi X-C [2009]. Controlling exposure to dpm: diesel particulate filters vs. biodiesel. 15th Annual Mining Diesel Emissions Conference (MDEC), Richmond Hill/Toronto, Ontario, Canada, October 5–9.
- Bugarski AD [2010]. The role of DPM loading on the filtration process in DFEs and DPFs. 16th Annual Mining Diesel Emissions Council (MDEC) Conference, North Toronto, Ontario, Canada, October 4–8.
- Cauda E, Bugarski A, Patts L [2010]. Diesel aftertreatment control technologies in underground mines: the NO<sub>2</sub> issue. Proceeding of 13th United States/North American Mine Ventilation Symposium, Sudbury, ON, June 13–17.
- Bugarski AD, Schnakenberg GH Jr., Hummer JA, Cauda E, Janisko SJ, Patts LD [2011]. Evaluation of high-temperature disposable filter elements in an experimental underground mine. 140th SME Annual Meeting and Exhibit, Denver CO, February 27–March 2.



## Project 50: Titanium Dioxide and Other Metal Oxides Exposure Assessment Study

**Principle Investigator:** Brian Curwin, PhD

**Project Duration:** FY 2006–2010

**Critical Topic Areas:** Measurement methods, exposure assessment

### Accomplishments and Research Findings

- Protocol for titanium dioxide study was written and underwent peer review.
- Critical exposure assessment equipment was purchased, including a TSI 3007 condensation particle counter, an Ecochem DC2000 CE portable diffusion charger, and a MOUDI impactor.
- A contract was awarded for support in company recruitment. Recruitment was completed in June 2008.
- Of the 189 companies contacted for recruitment, 10 initially agreed to participate and 7 companies were sampled.
- Company reports were sent to all participating companies.
  - Workers in large facilities and performing handling tasks had the highest mass concentrations for all analytes.
  - Medium size facilities had higher particle number concentrations in the air, followed by small facilities for all particle sizes measured.
  - Production processes generally had the highest particle number concentrations, particularly for the smaller particles.
  - Similar to particle number, the medium sized facilities and production process had the highest particle surface area concentration.
  - The TEM analysis confirmed the presence of the specific metal oxide particles of interest, and the majority of the particles were agglomerated, with the predominant particle size being between 0.1 and 1  $\mu\text{m}$ .
  - The greatest potential for exposure to workers occurred during handling process. However, the exposure is occurring at levels that are well below established and proposed limits.

### Publications and Abstracts

- Curwin B, Bertke S [2011]. Exposure characterization of metal oxide nanoparticles in the workplace. *J Occup Environ Hyg* 8(10):580–587.



### Invited Presentations

- Curwin B [2009]. Ask the Experts, an Update of the Metal Oxide Exposure Assessment Study. AIHce 2009, Toronto, Canada, May 30–June 4.
- Curwin B [2011]. Exposure Characterization of Metal Oxide Nanoparticles in the Workplace. International Society for Exposure Science (ISES) 2011, Baltimore, Maryland, October 23–27.

## Project 51: Field Research Team

**Principle Investigators:** Charles Geraci, PhD, CIH; Mark Methner, PhD, CIH; and Ken Martinez, MS, CIH

**Project Duration:** FY 2006–2012

**Critical Topic Area:** Exposure assessment

### Accomplishments and Research Findings:

#### Field Surveys

- Developed and published a method to evaluate potential emissions to engineered nanomaterials (nanomaterial emission assessment technique, or NEAT) that utilizes direct reading portable aerosol sampling equipment including optical particle counters and condensation particle counters, as well as filter-based sampling for electron microscopy and elemental analysis.
- The field team used the NEAT to evaluate potential emissions and to gain an understanding of nanomaterial research, manufacture, uses, and controls applied in the workplace. Knowledge gained led to creation of the sentinel document Approaches to Safe Nanotechnology.

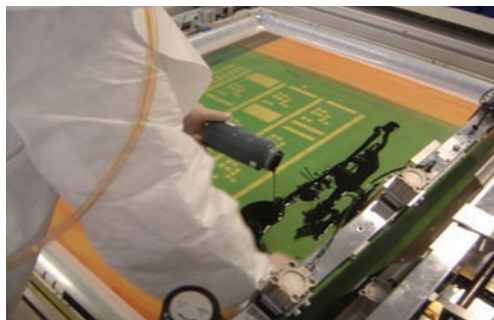
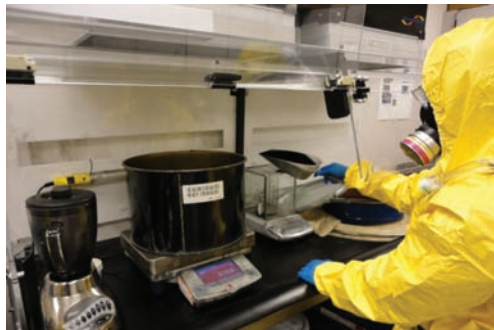

Nanomaterial workers



- Completed a survey as part of a health hazard evaluation at a research and development laboratory in 2005. This facility was incorporating CNF into polymers. Report issued in 2006.
- Completed three surveys during 2006, at a commercial nanoscale metal oxide powder production facility, a research and development laboratory engaged in the development of optical products with Quantum Dot (QD) coatings, and a facility spinning a nylon 6 nanofiber.
- Completed eight surveys during 2007, involving the following: a multi-walled carbon nanotube manufacturer; a metal oxide manufacturer (two site visits); a research and development laboratory that handles and compounds nanoscale polyhedral oligomeric silsesquioxanes (POSS); a manufacturer of nanoenhanced, silica-iron absorbent media; a pilot-scale research and development facility that creates nanoscale alumina via radiofrequency plasma torch reaction (two trips to evaluate chamber ventilation role in controlling releases during cleanout operations); and an environmental toxicology laboratory that conducts MWCNT and fullerene toxicology studies on invertebrates.
- Completed seven surveys during 2008, involving the following: a manufacturer that compounds/blends MWCNTs and boron carbide; a pilot-scale research and development laboratory that handles/processes MWCNTs for use in composite material production; a research and development laboratory that handles a variety of engineered nanomaterials (MWCNTs, metal oxides); a pilot-scale research and development facility that synthesizes and handles MWCNTs for inclusion in composite materials; a repeat visit to the development facility that creates nanoscale alumina; a research and development laboratory creating SWCNTs; and a Department of Defense Applied Toxicology Laboratory that handles engineered nanomaterials (elemental metals and oxides) for use in animal toxicological studies.
- Completed six surveys during 2009. Studied materials included MWCNT mats and yarns, SWCNT and MWCNTs, CNF,  $\text{CaPO}_4$ ,  $\text{CaF}_2$ , and various metal oxides.
- Completed nine surveys during 2010. Studied materials include single- and multi-walled carbon nanotubes, sheets and yarns manufactured from SWCNTs and MWCNTs, various metal oxides, carbon nanofibers, and plastic composite material containing carbon nanofibers.
- Designed local exhaust ventilation flange for use during metal oxide reactor cleanout operations; evaluated effectiveness of different engineering controls (e.g., local exhaust ventilation, ventilated enclosures).
- Developed a Framework Memorandum of Understanding between Department of Defense (DoD) and NIOSH regarding initial assessments at various DoD installations that create or handle nanomaterials.
- The NEAT was revised to reflect more focus on integrated sampling to conduct exposure assessment with supplementation from direct reading

instruments to characterize engineering control deficiencies and work practice problems.

- Revised the field study report format in response to more complex studies and the presentation of occupational safety and health criteria to create context for better communication of results to customers.
- Created a sample archival system that included the identification and use of appropriate storage space and the development of a database to track samples and site investigations.
- Completed nine surveys during 2011. Nanomaterials studied include CNT threads, CNF composites, silica, aluminum oxide, quantum dots, silver nanowires, and metal oxides (silver oxide, nickel oxide, iron oxide, and palladium oxide).

## Publications and Abstracts

- Methner MM, Birch ME, Evans DE, Ku B-K, Crouch K, Hoover MD, Mazzukelli LF (Ed.) [2007]. Case study: identification and characterization of potential sources of worker exposure to carbon nanofibers during polymer composite laboratory operations. *J Occup Environ Hyg* 4(12):D125–D130.

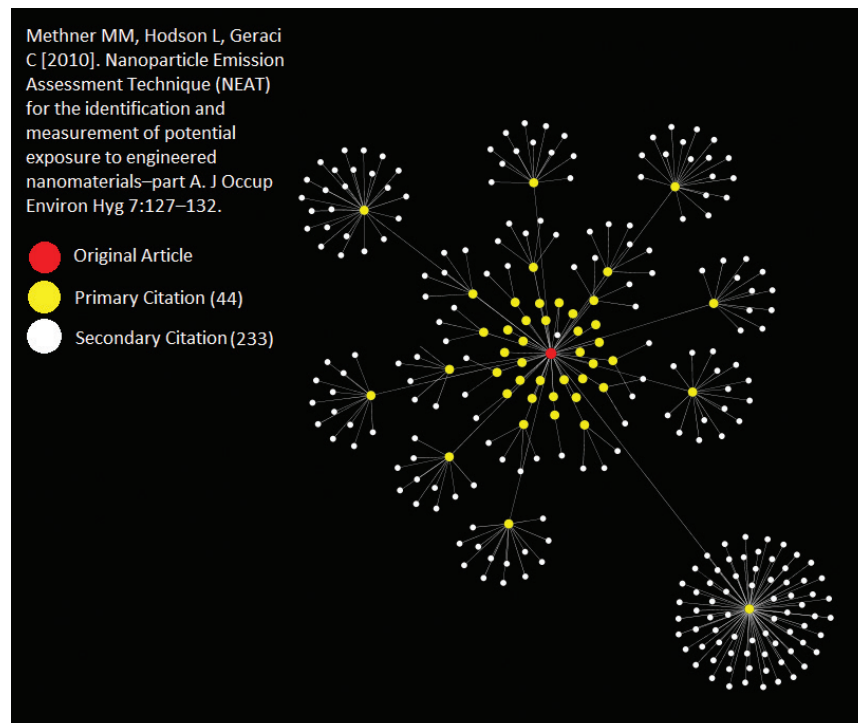

A graphical representation of the primary and secondary citations of the 2010 article Nanoparticle Emission Assessment Technique (NEAT) for the identification and measurement of potential inhalation exposure to engineered nanomaterials—part A



- Methner MM, Old L (Ed.) [2008]. Engineering case study: effectiveness of local exhaust ventilation in controlling engineered nanomaterial emissions during reactor cleanout operations. *J Occup Environ Hyg* 5(6):D63–69.
- Methner MM [2010]. Effectiveness of a custom-fitted flange and LEV system in controlling the release of nano-scale metal oxide particulate. *Intl J Occup Environ Health* 16:475–487.
- Johnson D, Methner M, Kennedy A, Steevens J [ 2010]. Potential for occupational exposure to engineered carbon-based nanomaterials in environmental laboratory studies. *Environ Health Perspect* 118(1):49–54.
- Methner MM, Hodson L, Geraci C [2010]. Nanoparticle Emission Assessment Technique (NEAT) for the identification and measurement of potential exposure to engineered nanomaterials—part A. *J Occup Environ Hyg* 7:127–132.
- Methner MM, Hodson L, Dames A, Geraci C [2010]. Nanoparticle Emission Assessment Technique (NEAT) for the identification and measurement of potential exposure to engineered nanomaterials—part B: results from 12 field studies. *J Occup Environ Hyg* 7:163–176.
- Methner M [2010]. Effectiveness of a custom-fitted flange and local exhaust ventilation (LEV) system in controlling the release of nanoscale metal oxide particulates during reactor cleanout operations. *Int J Occup Environ Health* 16(4):475–487.
- Gurumurthy R, Ostraat M, Evans DE, Methner M, O’Shaughnessy P, D’Arcy J, Geraci C, Stevenson E, Maynard A [2011]. A strategy for assessing workplace exposures to nanomaterials. *J Occup Environ Hyg* 8(11):673–685.

### Invited Presentations

- Methner MM, Hodson LL, Geraci CL [2008]. One day workshop: Nanoparticles in the workplace: demonstration of the instruments used when using the nanoparticle emission assessment technique (NEAT). American Industrial Hygiene Association, Central Ohio Section, Columbus, Ohio, April 22.
- Methner MM [2008]. Nanotechnology: ask the expert panel discussion: results pertaining to the field use of the nanoparticle emission assessment technique (NEAT). American Industrial Hygiene Association Conference and Exposition, Minneapolis, Minnesota, May 31–June 5.
- Methner MM, Hodson LL [2008]. Professional Development Course: Nanoparticles in the Workplace: Demonstration of the instruments used when using the nanoparticle emission assessment technique (NEAT). American Industrial Hygiene Association Conference and Exposition, Minneapolis, Minnesota, May 31–June 5.
- Mark D, Bard D, Wake D, Hoover MD, Stefaniak AB, Methner MM, Evans DE, Geraci CL [2008]. Problems and experiences of measuring worker



- exposure to engineered nanoparticles. International Inhalation Symposium, Hanover, Germany June 11–14.
- Methner MM, Hodson LL, Geraci CL [2008]. Professional Development Course: Nanoparticles in the workplace: demonstration of the instruments used when using the nanoparticle emission assessment technique (NEAT). American Industrial Hygiene Association, Ohio Valley Section, West Chester, Ohio, December 16.
  - Methner MM, Hodson LL, Geraci CL [2009]. Evaluating nanoparticle emissions in the workplace: a description of the approach used by NIOSH and a summary of findings from 12 site visits. NSTI–Nanotech 2009, Houston, Texas, May 3–7. ISBN 978-1-4398-1783-4 Vol. 2.
  - Methner MM [2010]. What's going on out there? The NIOSH field experience. Center for the Environmental Implications of Nanotechnology, University of California Los Angeles, October 13.
  - Hodson LL, Methner MM, Geraci CL, Crawford C [2010]. Findings from the NIOSH nanotechnology field research team. Nanomaterials and Worker Health: Medical Surveillance, Exposure Registries and Epidemiologic Research, Keystone, Colorado, July 21–23.
  - Methner MM, Hodson LL, Geraci CL, Crawford C [2010]. Findings from the NIOSH nanotechnology field research team: a photo documentary. Nanomaterials and Worker Health: Medical Surveillance, Exposure Registries and Epidemiologic Research, Keystone, Colorado, July 21–23.
  - Methner MM [2010]. Overview of experiences from the field. Ask the expert session: an update of the NIOSH nanotechnology program. American Industrial Hygiene Conference, Exposition (AIHce), Denver, Colorado, May 22–27.
  - Johnson DR, Methner MM, Kennedy AJ, Stevens JA [2010]. Potential for occupational exposure to carbon-based nanomaterials using common laboratory processes. Nanotechnology for Defense Conference, Atlanta, Georgia, May 3–6.
  - Beaucham CC, Dahm M, Evans D, Geraci C, Hodson L [2011]. Refining the nanoparticle emission assessment technique. 5th International NanOEI Meeting, Boston, Massachusetts, August 10–12.
  - Beaucham C [2011]. Gestión del riesgo ocupacional de la utilización de nanomaterials, Caracas, Venezuela, November 8.
  - Martinez KF [2011]. Nano-Materials: NIOSH's Current Approach to Exposure Assessment, San Francisco, California, December 5.
  - Martinez KF, Beaucham C, Sparks C [2011]. Occupational exposure assessment in the nanotechnology industry, a full day course. Irvine, California, December 7.





## Project 52: Factors Affecting Exposure to Engineered Nanomaterials

Principle Investigator: M. Abbas Virji, PhD

Project Duration: FY 2010–2011

Critical Topic Areas: Exposure assessment; epidemiology and surveillance

### Accomplishments and Research Findings

- Established collaborations with researchers at University of Massachusetts Lowell and Seoul National University to develop a model of nanoparticle exposure data analysis.
- Developed a conceptual model for collecting macro-, mid-, and micro-level exposure factors (contextual information) during exposure monitoring for multipurpose application.
- Developed a database for nanomaterial exposure data along with paper and electronic versions of sampling forms to collect contextual information during sampling.

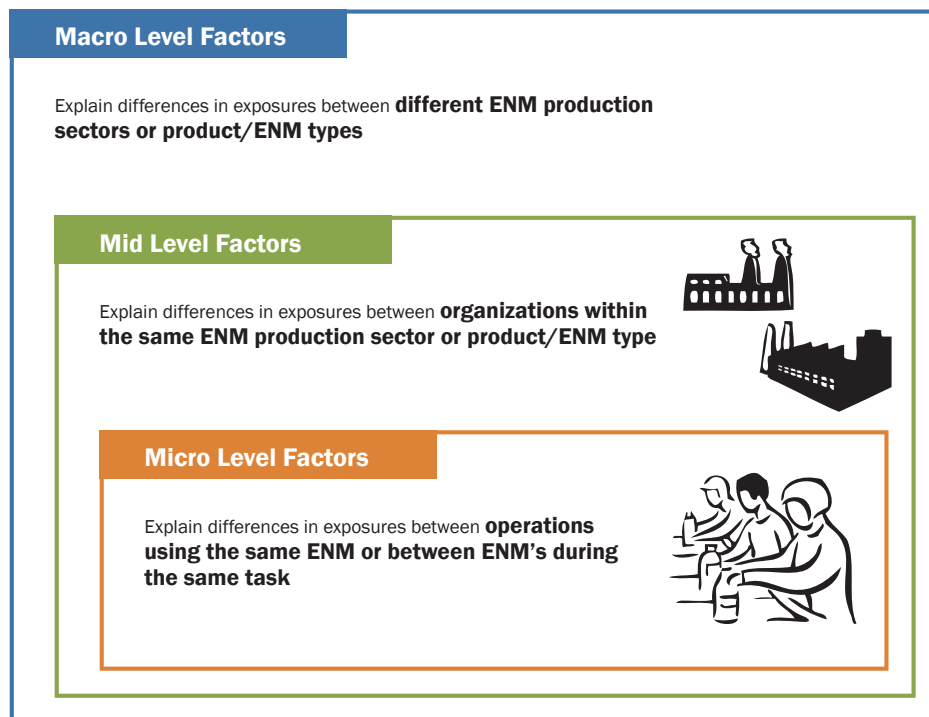

A multi-tiered model of Potential Exposure Determinants

- Conducted analysis of various nanomaterial exposures during a number of processes, using time series analysis in conjunction with mixed models analyses to investigate the fixed effects of workplace factors on exposure levels while accounting for correlation due to repeated measurements of the continuous exposures.
- Hosted researchers from TNO, the Netherlands, and University of Massachusetts, along with the NTRC (via envision) to discuss the harmonization of sampling strategy, data analyses and reporting, and database development of engineered nanomaterials.
- Member of the organizing committee and participant in the first international workshop on Nano Measurement Strategy and Database hosted by the TNO in Zeist, the Netherlands (Dec 16–17, 2010). Presented a position paper on data summarization and reporting. Participants agreed on the need to develop a harmonized strategy for monitoring, summarizing, reporting, and storing nano exposure data.
- Conducted comprehensive exposure assessment at a nano wire manufacturing facility for titanium dioxide and aluminum oxide, using time-integrated and real-time instruments, including assessment of the ventilation system and observations of tasks and activities.

### Publications and Abstracts

- Pfefferkorn FE, Bello D, Haddad G, Park J-Y, Powell M, McCarthy J, Bunker KL, Fehrenbacher A, Jeon Y M, Virji MA, Gruetzmacher G, Hoover MD [2010]. Characterization of exposures to airborne nanoscale particles during friction stir welding of aluminum. *Ann Occup Hyg* 54(5):486–503.
- Woskie SR, Bello D, Virji MA, Stefaniak AB [2010]. Understanding workplace processes and factors that determine exposure to nanomaterials. *Intl J Occup Environ Health* 16(4):365–377.
- Bello D, Wardle BL, Zhang J, Yamamoto N, Santeufemio C, Hallock M, Virji MA [2010]. Exposure to nanoscale particles and fibers during machining of hybrid CNT advanced composites II: abrasive drilling. *Intl J Occup Environ Health* 16(4):434–450.
- Brower D, Berges M, Virji MA, Fransman W, Bello D, Hodson L, Gabriel S, Tielemans E [2012]. Harmonization of measurement strategies for the assessment of exposure to manufactured nano object: report of a workshop. *Ann Occup Hyg* 56(1):1–9. Epub 2011 Dec 8.

### Invited Presentations

- Virji MA, Bello D [2010]. Nanomaterial data summarization and reporting. Workshop on Nano Measurement Strategy and Database, TNO, Zeist, The Netherlands, December 16–17.



- Ewert D, Geraci C, Virji MA, Hoover MD, Gilkey D, Kosnett M, Petroka G [2010]. A comprehensive occupational health program for emerging nanotechnology processes in a pharmaceutical facility. NIOSH Workshop on Nanomaterials and Worker Health: Medical Surveillance, Exposure Registries, and Epidemiologic Research, Keystone, Colorado, July 21–23.
- Park JY, Virji MA, Kim SW, Ramachandran G, Raynor PC [2011]. Field evaluation of a nanoparticle surface area monitor in workplaces generating incidental nanoparticles. 5th International NanoEHS Conference, Boston, Massachusetts, August 10–12.
- Brouwer D, Fransman W, Berges M, Virji MA, Bello D, Hodson L, Gabriel S, Tielemans E [2011]. Harmonization of measurement strategies for the assessment of exposure to manufactured nano object: report of a workshop. 5th International NanoEHS Conference, Boston, Massachusetts, August 10–12.

## **Project 53: Assessing the Feasibility of Industrywide Exposure and Epidemiology Studies of Workers Exposed to Engineered Nanomaterials—Phase I**

**Principle Investigator:** Mary Schubauer-Berigan, PhD

**Project Duration:** FY 2008–2009

**Critical Topic Areas:** Epidemiology and surveillance

### **Accomplishments and Research Findings**

- Developed and funded a statement of work to collect and compile information on the size, characteristics, and future trends of the U.S. workforce involved in the manufacture of engineered carbonaceous nanomaterials.
- Attended the 2008 Micro Nano Breakthrough Conference in Vancouver, Washington, to learn about the latest applications of engineered carbonaceous nanomaterials as well as possible timeframes and barriers for transition from startup to full-scale production for the most promising applications.
- Reviewed and compiled information on companies identified as manufacturers of engineered carbonaceous nanomaterials in the Lux Report (fourth and fifth editions), supplemented with information collected from Dun and Bradstreet.
- Contacted and conducted interviews with health and safety managers at each identified company to confirm the information collected on workforce size, location, characteristics of the nanomaterials produced, and use of engineering controls and personal protective equipment.
- Developed a report and two journal articles on the feasibility of conducting industrywide exposure surveys and epidemiological studies among this workforce.
- Made presentations describing results at conference on Medical Surveillance and Epidemiology for Nanomaterials (Keystone, Colorado, July 2010).

### **Publications and Abstracts**

- Schubauer-Berigan M, Dahm M, Yencken M [2011]. Engineered carbonaceous nanomaterials manufacturers in the United States: workforce size,



characteristics and feasibility of epidemiologic studies. *J Occup Environ Med* 53(6S):S62–S67.

- Dahm M, Yencken M, Schubauer-Berigan M [2011]. Exposure control strategies in the carbonaceous nanomaterial industry. *J Occup Environ Med* 53(6S):S68–S73.

### Invited Presentations

- Schubauer-Berigan MK, Dahm MM [2010]. Engineered carbon nanomaterials workers: Is it time to conduct epidemiology studies? *Nanomaterials & Worker Health: Medical Surveillance, Exposure Registries, & Epidemiologic Research*, Keystone, CO, July 21–23.
- Schubauer-Berigan MK, Dahm MM [2010]. Engineered carbon nanomaterials workforce: Feasibility of industrywide exposure assessment and epidemiology studies. Presented at the 2010 American Industrial Hygiene Conference and Exposition, Denver, CO, May 25.
- Schubauer-Berigan MK, Trout DB, Schulte PA [2011]. Medical Surveillance among nanomaterials workers: Recommendations from the NIOSH Keystone Conference. Presented at “Nanomaterials: Risk Perception & Early Warning Systems” International Workshop, Berlin, May 25–26.
- Schubauer-Berigan MK, Dahm MM [2011]. Feasibility of epidemiologic studies among engineered carbon nanomaterials workers. *Sigma Xi Scientific Research Society*, Cincinnati chapter, February 2.

## **Project 54: Engineered Carbon Nanomaterials Workforce: Feasibility of Industrywide Exposure Assessment and Epidemiology Studies on Carbon Nanotubes and Nanofibers—Phase II**

**Principle Investigators:** Matthew Dahm, MPH; Mary Schubauer-Berigan, PhD

**Project Duration:** FY 2010–2011

**Critical Topic Areas:** Epidemiology and surveillance; exposure assessment

### **Accomplishments and Research Findings**

- Recruited companies to participate in phase II of the feasibility study (for industrywide exposure assessment and epidemiology studies of the CNT & CNF workforce).



Nanomaterial workers



- Conducted 6 exposure assessment site visits at 3 primary manufacturers (producers), as well as 3 secondary manufacturers (users) of SWCNTs, MWCNTs, and CNFs for FY 2010.
- Six additional exposure assessment site visits were conducted at one primary manufacturer and five secondary manufacturers of MWCNTs and SWCNTs during FY 2011.
- Developed a consistent sampling approach for CNTs and CNFs.
- Was able to observe typical forms of production and uses of the material(s).
- Personal and area samples collected, using both real-time instruments and filter-based sampling, to study several different exposure metrics.
  - Real-time instrument metrics: surface area, respirable mass, particle counts.
  - Filter-based: respirable and inhalable mass of elemental carbon (NMAM 5040) and CNT structure counts by TEM (NMAM 7402).
- Concluded that detectable levels of exposure are occurring in workplaces and that gradients of exposure can be determined with current exposure assessment methods.
- Made important contacts with companies and explained the future goals of the IWSB epidemiological/biomarker study (phase III) to company officials/workers.
- Sent detailed reports describing site visit and analytical results, along with recommendations to improve material handling processes at all surveyed companies.
- Drafted a protocol for industrywide exposure assessment and epidemiologic study.

### Publications and Abstracts

- Dahm M, Evans D, Schubauer-Berigan M, Birch ME, Fernback J [2012]. Occupational exposure assessment in carbon nanotube and nanofiber primary and secondary manufacturers. *Ann Occup Hyg* 56(5):542–556. DOI:10.1093/annhyg/mer110.

### Invited Presentations

- Schubauer-Berigan M, Dahm M, Geraci C [2010]. Engineered carbon nanomaterials workforce: Feasibility of industrywide exposure assessment and epidemiology studies. Presented at AIHce roundtable, Ask the expert: an update on the NIOSH nanotechnology research program. AIHce: Denver, Colorado, May 25.
- Dahm M, Yencken M, Schubauer-Berigan M [2010]. Exposure control strategies in the carbonaceous nanomaterial industry. *Nanomaterials and Worker Health: Medical Surveillance, Exposure Registries, and Epidemiologic Research Conference*, Keystone, Colorado, July 21–23.



- Schubauer-Berigan M, Dahm M [2010]. Engineered carbon nanomaterials workforce: feasibility of industrywide exposure assessment and epidemiology studies. Nanomaterials and Worker Health: Medical Surveillance, Exposure Registries, and Epidemiologic Research Conference, Keystone, Colorado, July 21–23.
- Dahm M, Schubauer-Berigan M [2011]. Industrywide studies: evaluating and addressing workplace exposures to carbon nanotubes and nanofibers. Ohio Innovation Summit, Toledo, Ohio, April 19–20.
- Dahm M, Schubauer-Berigan M [2011]. Nanomaterials exposure assessment: status of the NIOSH carbon nanotube and nanofiber industrywide study. Ask the expert: an update on the NIOSH nanotechnology research program. AIHce, Portland, Oregon, May 14–19.
- Schubauer-Berigan M, Trout D, Schulte P [2011]. Medical surveillance among nanomaterials workers: recommendations from the NIOSH Keystone Conference. Nanomaterials: Risk Perception & Early Warning Systems International Workshop: Berlin, Germany, May 26.
- Dahm M, Evans D, Schubauer-Berigan M, Birch ME, Fernback J [2011]. Occupational exposure assessment in carbon nanotube and nanofiber primary and secondary manufacturers. 5th International Symposium on Nanotechnology, Occupational and Environmental Health, Boston, Massachusetts, August 10–12.



## Project 55: Nanoparticles—Dosimetry and Risk Assessment

**Principle Investigator:** Eileen D. Kuempel, PhD

**Project Duration:** FY 2005–2012

**Critical Topic Area:** Risk assessment

### Accomplishments and Research Findings

- Coordinated the NTRC Critical Research Area in Risk Assessment.
- Developed research collaborations in dosimetry and risk assessment of nanomaterials, including with the following:
  - Institute of Occupational Medicine (IOM), Edinburgh, UK, and EU 7th Framework Program on Risk Assessment of Engineered Nanoparticles (ENPRA)
  - Toxicology Excellence for Risk Assessment (TERA)
  - Applied Research Associates (ARA), Raleigh, NC
  - Lovelace Respiratory Research Institute, Albuquerque, NM
  - The Hamner Institutes for Health Sciences, Research Triangle Park, NC
  - Provided presentations and contributed to publications pertaining to dosimetry, risk assessment, and occupational exposure limits (OELs) for nanoparticles.
- Represented NIOSH in the Organization for Economic Cooperation and Development (OECD) Study Group 6 (SG6) to develop guidance on critical issues in nanotechnology risk assessment.
- Contributed to quantitative risk assessments used in developing draft NIOSH recommended exposure limits (RELs) for titanium dioxide and for carbon nanotubes/fibers.
- Developed and published risk assessment methods for inhaled poorly soluble particles, including nanoparticles.
- Completed nanoparticle dosimetry model in rats. Dosimetry model describes clearance, retention, and translocation from lungs to systemic circulation and early biological responses. Model calibration used dose-response data from NIOSH animal studies (IOM/NIOSH research collaboration).
- Completed olfactory deposition model of spherical nanoparticles in humans and in rats. Revised multipath particle deposition (MPPD) model to include site-specific deposition efficiency in nasal-pharyngeal region. Published rat

model and prepared manuscript of human model (Hamner Institute/NIOSH research collaboration).

- Developing modeling methods to predict human respiratory tract deposition model for carbon nanofiber/nanotube structures based on fiber aerosol theory (Hamner Institute and ARA/NIOSH research collaborations).
- Completed experiments to characterize deposition of airborne carbon nanotubes in a human respiratory tract replica. Data are being used in the human lung deposition model for carbon nanofibers/nanotubes being developed by ARA (LRRRI/NIOSH collaboration).
- Presented research and risk assessment findings at several scientific conferences and a public review meeting.
- Published scientific articles on inhalation dosimetry and risk assessment methods for occupational exposure to nanomaterials and contributed to NIOSH guidance documents.

## Publications and Abstracts

- Maynard AM, Kuempel ED [2005]. Airborne nanostructured particles and occupational health. *J Nanoparticle Res* 7(6):587–614.
- Kuempel ED, Wheeler M, Smith R, Bailer AJ [2005]. Quantitative risk assessment in workers using rodent dose-response data of fine and ultrafine titanium dioxide [abstract]. In: *Nanomaterials: a risk to health at work? First*

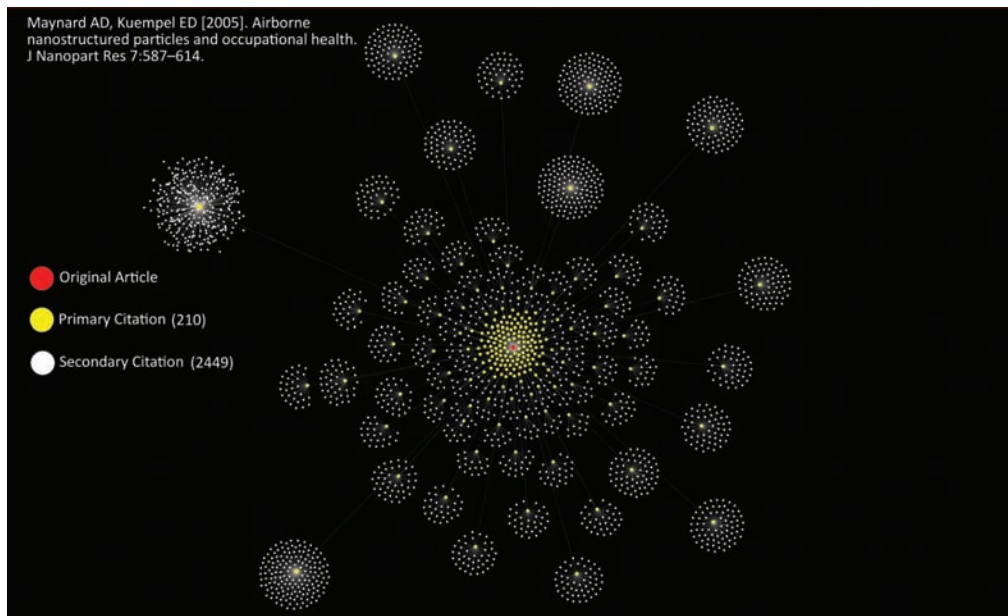

A graphical representation of the 210 primary and 2,449 secondary citations of *Airborne nanostructured particles and occupational health*



International Symposium on Occupational Health Implications of Nanomaterials, 12–14 October 2004, Buxton, Derbyshire, UK, Report of Presentations at Plenary and Workshop Sessions and Summary of Conclusions. Buxton: Health and Safety Executive, UK, p. 111.

- Kuempel ED, Aitken RJ [2005]. Regulatory implications of nanotechnology: summary of discussion and recommendations from Workshop G. In: Nanomaterials: a risk to health at work? First International Symposium on Occupational Health Implications of Nanomaterials, 12–14 October 2004, Buxton, Derbyshire, UK, Report of Presentations at Plenary and Workshop Sessions and Summary of Conclusions. Buxton: Health and Safety Executive, UK, pp. 142–143.
- Kuempel ED, Tran CL, Castranova V, Bailer AJ [2006]. Lung dosimetry and risk assessment of nanoparticles: evaluating and extending current models in rats and humans. *Inhal Toxicol* 18(10):717–724.
- Maynard AM, Kuempel ED [2006]. Addressing the potential environmental and human health impact of engineered nanomaterials. In: The Symposium Q. Proceedings of the 3rd International Conference on Materials for Advanced Technologies (ICMAT), Singapore, July 3–8.
- Kuempel ED [2007]. Estimating nanoparticle dose in humans: issues and challenges. In: Monteiro-Riviere NA, Tran CL, eds. *Nanotoxicology: characterization, dosing, and health effects*. New York: Informa Healthcare USA Inc., pp. 141–152.
- Kuempel ED, Geraci CL, Schulte PA [2007]. Risk assessment approaches and research needs for nanoparticles: an examination of data and information from current studies. In: Simeonova PP, Opopol N, Luster MI, eds. *Nanotechnology: toxicological issues and environmental safety*. NATO security through science series book. New York: Springer-Verlag, pp. 119–145.
- Dankovic D, Kuempel E, Wheeler M [2007]. An approach to risk assessment for TiO<sub>2</sub>. *Inhal Toxicol* 19(Suppl 1):205–212.
- Tran CL, Kuempel ED [2007]. Biologically based lung dosimetry and exposure-dose-response models for poorly soluble, inhaled particles. In: Donaldson K, Borm P, eds. *Particle toxicology*. Boca Raton, FL: CRC Press, Taylor and Francis Group, Chapter 20.
- Kuempel ED, Tran CL, Castranova V, Bailer AJ [2007]. Response to letter to the editor from Dr. Peter Morfeld [re: Lung dosimetry and risk assessment of nanoparticles: evaluating and extending current models in rats and humans; 18(10):717–24]. *Inhal Toxicol* 19(2):197–198.
- Garcia GJM, Nazridoust K, Kimbell JS [2008]. Nanoparticle deposition in the rat nasal cavity: prediction of dose to the olfactory epithelium. *Toxicologist* 102(1):204.

- Schulte P, Geraci C, Zumwalde R, Hoover M, Kuempel E [2008]. Occupational risk management of engineered nanoparticles. *J Occup Environ Hyg* 5(4):239–249.
- Schulte PA, Trout D, Zumwalde RD, Kuempel E, Geraci CL, Castranova V, Mundt DJ, Mundt KA, Halperin WE [2008]. Options for occupational health surveillance of workers potentially exposed to engineered nanoparticles: state of the science. *J Occup Environ Med* 50(5):517–526.
- Schulte P, Geraci C, Zumwalde R, Hoover M, Castranova V, Kuempel E, Murashov V, Vainio H, Savolainen K [2008]. Sharpening the focus on occupational safety and health in nanotechnology. *Scand J Work Environ Health* 34(6):471–478.
- Dankovic DA, Kuempel ED, Wheeler MW [2009]. Your results may vary: exploring the sensitivity of titanium dioxide risk estimates to different modeling assumptions. *Toxicologist* 108(1):305.
- Kuempel ED, Smith RJ, Dankovic DA, Stayner LT [2009]. Rat- and human-based risk estimates of lung cancer from occupational exposure to poorly-soluble particles: a quantitative evaluation. *J Phys Conf Ser* 151(1):012011.
- MacCalman L, Tran CL, Kuempel E [2009]. Development of a bio-mathematical model in rats to describe clearance, retention and translocation of inhaled nano particles throughout the body. *J Phys Conf Ser* 151(1):012028.
- Garcia GJ, Kimbell JS [2009]. Deposition of inhaled nanoparticles in the rat nasal passages: dose to the olfactory region. *Inhal Toxicol* 21(14):1165–1175.
- NIOSH [2009]. Approaches to safe nanotechnology: managing the health and safety concerns associated with engineered nanomaterials. Cincinnati, OH: U.S. Department of Health and Human Services, Public Health Service, Centers for Disease Control and Prevention, National Institute for Occupational Safety and Health. DHHS (NIOSH) Publication No. 2009–125.
- Schulte PA, Murashov V, Zumwalde R, Kuempel ED, Geraci CL [2010]. Occupational exposure limits for nanomaterials: state of the art. *J Nanoparticle Res* 12(6):1971–1987.
- Schulte PA, Geraci CL, Zumwalde R, Castranova V, Kuempel E, Methner MM, Hoover M, Murashov V [2010]. Nanotechnologies and nanomaterials in the occupational setting. *Ital J Occup Environ Hyg* 1(2):63–68.
- OECD [2010]. Report of the workshop on risk assessment of manufactured nanomaterials in a regulatory context. Organization for Economic Cooperation and Development. OECD Environment, Health, and Safety Publications. Series on the Safety of Manufactured Nanomaterial, No. 21. ENV/JM/MOMO(2010)10, 16 Apr.
- Kuempel ED [2011]. Carbon nanotube risk assessment: implications for exposure and medical monitoring. *J Occup Environ Med* 53(6)(Suppl):S91–S97.



- Dankovic D, Kuempel E, Geraci C, Gilbert S, Rice F, Schulte P, Smith R, Sofge C, Wheeler M, Lentz TJ, Zumwalde R, Maynard A, Attfield M, Pinheiro G, Ruder A, Hubbs A, Ahlers H, Lynch D, Toraason M, Vallyathan V [2011]. Current intelligence bulletin 63: occupational exposure to titanium dioxide Cincinnati, OH: U.S. Department of Health and Human Services, Public Health Service, Centers for Disease Control and Prevention, National Institute for Occupational Safety and Health, DHHS (NIOSH) Publication No. 2011-160.
- Kuempel E, Castranova V [2011]. Hazard and risk assessment of workplace exposure to engineered nanoparticles: methods, issues, and carbon nanotube case study. In: Ramachandran G, ed. Assessing nanoparticle risks to human health. Micro & Nano Technologies Series. Boston: William Andrew Publishing, pp. 65-97.

### Invited Presentations

- Kuempel ED [2007]. Review of hazard information on nanoparticles: as relates to occupational health surveillance. Workshop on occupational health surveillance and nanotechnology workers, Washington, DC, April 17.
- Geraci CL, Schulte PA, Zumwalde R, Kuempel E, Hoover M [2007]. Occupational risk management for nanomaterials along the product life cycle. International Symposium on Nanotechnology, Occupational, and Environmental Health, Taipei, Taiwan, August 29-September 1.
- Schulte PA, Murashov VV, Geraci CL, Zumwalde RD, Hoover MD, Castranova V, Kuempel ED [2007]. Current occupational safety and health issues of nanotechnology in the USA. European NanOSH Conference—Nanotechnologies: A Critical Area in Occupational Safety and Health, Helsinki, Finland, December 3-5.
- MacCalman L, Tran CL, Kuempel E [2008]. Development of a biomathematical model in rats to describe the retention, clearance, and translocation of nanoparticles from the lungs. Inhaled Particles X Conference, Sheffield, United Kingdom, September 23-25.
- Kuempel ED, Smith RJ, Dankovic DA, Stayner LT [2008]. Rat- and human-based risk estimates of lung cancer from occupational exposure to poorly soluble particles: a quantitative evaluation. Inhaled Particles X Conference, Sheffield, United Kingdom, September 23-25.
- MacCalman L, Tran L, Kuempel E [2008]. Developing and testing a biomathematical model to describe particle size-specific clearance and translocation of nanoparticles in rats. Nanotoxicology—Second International Nanotoxicology Conference, Zurich, Switzerland, September 7-10.
- Schulte PA, Kuempel E, Castranova V, Trout D [2008]. Assessing the toxicological evidence base for medical surveillance of workers potentially exposed

- to engineered nanoparticles. Second International Nanotoxicology Conference, Zurich, Switzerland, September 7–10.
- Kuempel ED [2008]. Should engineered nanoparticles be considered new chemicals? NTRC Annual Meeting, Morgantown, West Virginia, January 23.
  - Kuempel E [2009]. Nanotoxicology and risk assessment: current trends and NIOSH research. Kick-off Meeting for the Engineered Nanoparticles Risk Assessment (ENPRA) Collaborative Research Program in the EU and US, Paris, France, May 14.
  - Kuempel E [2009]. Risk assessment of nanomaterials: current trends and NIOSH research. Meeting between NIOSH and the U.K. House of Lords Science and Technology Committee on Nanoparticles in Food, Washington, DC, June 23.
  - Kuempel E [2009]. Risk assessment case study: carbon nanotubes. Organization for Economic Cooperation and Development (OECD) Workshop on Risk Assessment of Manufactured Nanomaterials in a Regulatory Context, Washington, DC, September 17.
  - Kuempel E, Zumwalde R [2010]. Risk assessment of carbon nanotubes and status of NIOSH current intelligence bulletin. NTRC 2010 Update, Wheeling, West Virginia, April 20.
  - Kuempel E [2010]. Carbon nanotube risk assessment: implications for medical screening. Nanomaterials and Worker Health: Medical Surveillance, Exposure Registries, and Epidemiological Research, Keystone, Colorado, July 21–23.
  - Kuempel E [2010]. Carbon nanotube risk assessment: using toxicology data to develop RELs. NIOSH Intramural Science Conference, Salt Fork, Ohio, August 10–11.
  - Kuempel E [2010]. Nanoparticles: lung dosimetry and risk assessment. NTRC Program Review, Cincinnati, Ohio, October 4.
  - Kuempel E [2010]. Assessing occupational health risk of nanofibers: lessons learned from asbestos. National Institute of Occupational Health, Webster Day Event, Johannesburg, South Africa, November 10.
  - Kuempel E [2011]. Risk assessment of carbon nanotubes. NIOSH Public Review Meeting on the Draft Current Intelligence Bulletin on Occupational Exposure to Carbon Nanotubes and Nanofibers, Cincinnati, Ohio, February 3.
  - Kuempel E [2011]. Occupational health risk assessment and CNT case study. Guest lecture in a graduate course at the University of Michigan, Ann Arbor, Michigan, March 24.
  - Kuempel E, Geraci C, Schulte P [2011]. Risk assessment and risk management of nanomaterials in the workplace: what we know and what we still need to know. The Institut National de Recherche et de Sécurité (INRS) Occupational





Health Research Conference: Risks Associated to Nanoparticles and Nanomaterials, Nancy, France, April 5 [Keynote presentation].

- Kuempel E [2011]. Risk assessment of nanomaterials. American Industrial Hygiene Association, in Roundtable 215: Ask the Expert: Update on NIOSH Nanotechnology Research Program, Portland, Oregon, May 17.
- Kuempel ED, Geraci CL, Castranova V, Schulte PA [2011]. Development of risk-based nanoparticle groups for occupational exposure control. The 5th International Conference on Nanotechnology–Occupational and Environmental Health (NanOEH), Boston, Massachusetts, August 10–12.
- Schulte P, Kuempel E, Zumwalde R, Geraci C, Schubauer-Berigan M, Castranova V, Hodson L, Murashov V, Ellenbecker M [2011]. Focused actions to protect carbon nanotube workers. The 5th International Symposium on Nanotechnology Occupational and Environmental Health, Boston, Massachusetts, August 10–12.
- Schulte PA, Kuempel ED, Castranova V, Geraci C, Hoover MD, Stefaniak A, Hodson L, Zumwalde R, Murashov V [2011]. Issues in establishing categorical occupational exposure limits for nanomaterials. The 5th International Conference on Nanotechnology–Occupational and Environmental Health (NanOEH), Boston, Massachusetts, August 10–12.
- Kuempel ED, Geraci CL [2011]. NIOSH draft current intelligence bulletin: occupational exposure to carbon nanotubes and nanofibers. Society for Chemical Hazard Communication (SCHC) Fall Meeting, Arlington, Virginia, October 4.
- Su W-C, Cheng YS [2011]. A new experimental method to measure the deposition of carbon nanotubes in the human airway replica. The American Association for Aerosol Research (AAAR), Orlando, Florida, October 4.
- Kuempel ED [2011]. Methods and uncertainties in carbon nanotube risk assessment. Society for Risk Analysis Annual Meeting, Charleston, South Carolina, December 5.

## Project 56: Titanium Dioxide Quantitative Risk Assessment

**Principle Investigators:** David Dankovic, PhD; Eileen Kuempel, PhD; Faye Rice, MS; Christine Sofge, PhD

**Project Duration:** FY 2005–2011

**Critical Topic Areas:** Risk assessment, recommendations, and guidance

### Accomplishments and Research Findings

- Responded to external review, public, and stakeholder comments on a draft Current Intelligence Bulletin (CIB) on titanium dioxide.
- The CIB was published in 2011. The CIB describes the risk of potential adverse respiratory effects from exposure to either fine (pigment-grade) or ultrafine (nano-size) titanium dioxide, including recommended exposure limits (RELs) for both fine and ultrafine particles.

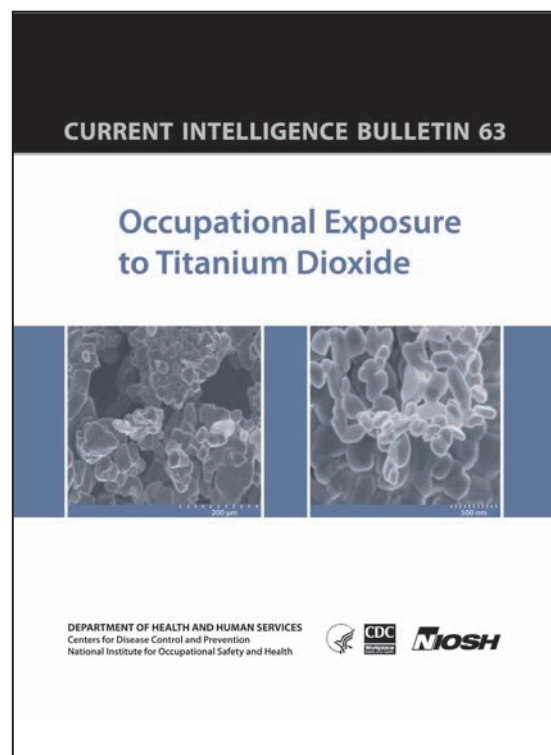

Cover of the *Current Intelligence Bulletin 63: Occupational Exposure to Titanium Dioxide*



## Publications and Abstracts

- Dankovic D, Kuempel E, Wheeler M [2006]. An approach to risk assessment for TiO<sub>2</sub>. In: Proceedings of the 10th International Inhalation Symposium on Airborne Particulate Matter: Relevance of Particle Components and Size for Health Effects and Risk Assessment, Hannover, Germany, May 31–June 3.
- Dankovic D, Kuempel E, Wheeler M [2007]. An approach to risk assessment for TiO<sub>2</sub>. *Inhal Toxicol* 19(Suppl 1):205–212.
- Dankovic DA, Kuempel ED, Wheeler MW [2009]. Your results may vary: exploring the sensitivity of titanium dioxide risk estimates to different modeling assumptions. *Toxicologist* 108(1):305.
- Dankovic D, Kuempel E, Geraci C, Gilbert S, Rice F, Schulte P, Smith R, Sofge C, Wheeler M, Lentz TJ, Zumwalde R, Maynard A, Attfield M, Pinheiro G, Ruder A, Hubbs A, Ahlers H, Lynch D, Toraason M, Vallyathan V [2011]. Current intelligence bulletin 63: occupational exposure to titanium dioxide. Cincinnati, OH: U.S. Department of Health and Human Services, Public Health Service, Centers for Disease Control and Prevention, National Institute for Occupational Safety and Health, DHHS (NIOSH) Publication No. 2011–160.

## Invited Presentations

- Dankovic DA, Kuempel ED, Wheeler MW [2009]. Your results may vary: exploring the sensitivity of titanium dioxide risk estimates to different modeling assumptions. Poster presented at the Society of Toxicology Annual Meeting, Baltimore, Maryland, March 18. Recognized by the Risk Assessment Specialty Section of the Society of Toxicology as outstanding presentation.

## Project 57: Engineering Controls for Nanomaterial Handling

**Principle Investigators:** Li-Ming Lo, PhD; Kevin H. Dunn, MS, CIH; Jennifer Topmiller, MS

**Project Duration:** FY 2010–2012

**Critical Topic Areas:** Engineering controls, recommendations, and guidance

### Accomplishments and Research Findings

- The draft of the guidance document titled *Current Strategies for Engineering Controls in Nanomaterial Handling Processes* (EPHB report 356–14a) completed internal review in 2011 and is being prepared for external review. The topics covered include a summary of exposure control strategies, an overview of engineering controls for nanotechnology processes, and strategies for evaluating engineering control effectiveness.
- Two in-depth site surveys were conducted in 2010 to assess the performance of ventilated enclosures, at a manufacturing facility for carbon nanotubes (CNTs) and at another for nanographene platelets (NGPs). Process and task-based exposures were evaluated by direct-reading instruments. Enclosure design and operation factors were assessed with thermal anemometry and airflow visualization techniques. Recommendations were discussed and included improved enclosure design and containment of contamination in production areas through general ventilation pressurization schemes. Both survey reports have been finalized.
- Two in-depth site surveys were conducted in 2011 to evaluate the control effectiveness of engineering controls at nanocomposite companies. The controls evaluated at these plants included a laboratory fume hood, canopy hood, downdraft table, and downflow room. Task-based exposure assessments included tasks such as weigh-out of nanomaterials, mixing, and post-processing of composite goods (such as manual and powered cutting). Good containment was seen with the laboratory fume hood when the unit was operated properly. The use of a HEPA-filtered downflow room also maintained low contaminant concentrations during nanomaterial manufacturing and handling. Some controls were ineffective, and recommendations were made to improve their design or operation. Both draft reports are being reviewed.
- One case study was completed in 2011 to evaluate process change and ventilation in reducing exposure during product harvesting and equipment cleaning at a nanographene production facility. The study showed that increasing wait times prior to product harvesting (allowing airborne products to settle into the collection containers) can significantly lower nanomaterial emissions. In



addition, the use of available process exhaust ventilation helped the facility eliminate particle emissions during maintenance of the process tank and save the nanomaterials for reuse. The study report is being prepared.

- A laboratory study was conducted to assess the performance of an enclosure used to handle nanomaterials. Initial tests of nanomaterial handling have shown that nanopowders can easily migrate to the breathing zone of a worker without the use of proper controls. A test rig has been constructed to produce nanomaterial aerosols (including salts, multi-walled CNTs, TiO<sub>2</sub>, SiO<sub>2</sub>, and Al<sub>2</sub>O<sub>3</sub>) for assessing enclosure containment effectiveness. A sampling probe array is being designed to provide better detection of enclosure leakage during tests with trace gas and nanomaterials.

## Publications

- Evans DE, Ku BK, Birch ME, Dunn KH [2010]. Aerosol monitoring during carbon nanofiber production: mobile direct-reading sampling *Ann Occup Hyg* 54(5):514–531.
- Lo LM, Dunn KH, Hammond D, Almaguer D, Bartholomew I, Topmiller J, Tsai CSJ, Ellenbecker M, Huang CC [2011]. Evaluation of engineering controls for manufacturing nanofiber sheets and yarns. Cincinnati, OH: U.S. Department of Health and Human Services, Public Health Service, Centers for Disease Control and Prevention, National Institute for Occupational Safety and Health, DHHS (NIOSH) Report No. EPHB 356–11a.
- Lo LM, Hammond D, Bartholomew I, Almaguer D, Heitbrink W, Topmiller J [2012]. Engineering controls for nano-scale graphene platelets during manufacturing and handling processes. Cincinnati, OH: U.S. Department of Health and Human Services, Public Health Service, Centers for Disease Control and Prevention, National Institute for Occupational Safety and Health, DHHS (NIOSH) Report No. EPHB 356–12a.
- Topmiller J, Dunn KH, Earnest S, Lo LM, Gressel M, Echt A, Hall R [2012]. Current strategies for engineering controls in nanomaterial handling processes. Cincinnati, OH: U.S. Department of Health and Human Services, Public Health Service, Centers for Disease Control and Prevention, National Institute for Occupational Safety and Health, DHHS (NIOSH) Report No. EPHB 356–14a [being prepared for external review].
- Lo LM, Hammond D, Dunn KH, Marlow D, Topmiller J, Tsai CSJ, Ellenbecker M, Huang CC [2012]. Evaluation of engineering controls in a manufacturing facility producing carbon nanotube-based products. Cincinnati, OH: U.S. Department of Health and Human Services, Public Health Service, Centers for Disease Control and Prevention, National Institute for Occupational Safety and Health, DHHS (NIOSH) Report No. EPHB 356–13a [draft in reviewed].

- Heitbrink WA, Lo LM, Farwick DF [2012]. Evaluation of enclosing hood and downflow room for nanocomposite manufacturing. Cincinnati, OH: U.S. Department of Health and Human Services, Public Health Service, Centers for Disease Control and Prevention, National Institute for Occupational Safety and Health, DHHS (NIOSH) Report No. EPHB 356–16a [draft in review].

## Invited Presentations

- Dunn KH, Lo LM, Heitbrink W, Garcia A, Topmiller J [2010]. Engineering Control Strategies for Nanomaterials: Current State of Knowledge and Future Research Needs. NIOSH NTRC Science Meeting, Oglebay Resort & Conference Center, Wheeling, West Virginia, April 19–21.
- Lo LM, Dunn KH, Heitbrink W, Garcia A, Topmiller J [2010]. Field Evaluation of Engineering Controls for Nanomaterial Manufacturing. Poster presentation at NIOSH NTRC Science Meeting, Oglebay Resort & Conference Center, Wheeling, West Virginia, April 19–21.
- Tsai C, Huang CC, Ellenbecker M, Dunn KH [2011]. The optimum approach to control nanoparticle exposure using local exhaust ventilation. American Industrial Hygiene Conference and Exposition, Portland, Oregon, May 14–19.
- McKernan JL, Geraci C, Dunn KH, Tsai S-J, Ellenbecker MJ [2011]. Engineering control recommendations for nanomaterials. Poster presentation at the American Industrial Hygiene Conference and Exposition, Portland, Oregon, May 14–19.
- Lo LM, Dunn KH, Hammond D, Almaguer D, Bartholomew I, Topmiller J, Tsai C, Ellenbecker M, Huang CC [2011]. Assessing control measures for mitigating exposures during the production of carbon nanotubes. Poster presentation at 2011 National Occupational Research Agenda (NORA) Symposium. Cincinnati, Ohio, July 12–13.
- Dunn KH, Tsai C, Huang CC, Ellenbecker M [2011]. Evaluation of nanoparticle dispersion and leakage from fume hoods using computational fluid dynamics. 5th International Symposium on Nanotechnology, Occupational and Environmental Health (NanOEH), Boston, Massachusetts, August 9–12.
- Lo LM, Bartholomew I, Almaguer D, Heitbrink W, Hammond D, Topmiller J [2011]. Field evaluation of emission controls for the processing of nanographene materials. Poster presentation at the 5th International Symposium on Nanotechnology–Occupational and Environmental Health (NanOEH), Boston, Massachusetts, August 9–12.
- Lo LM, Hammond D, Bartholomew I, Almaguer D, Topmiller J [2011]. Evaluation of engineering controls for occupational exposure to airborne nanomaterials. Poster presentation at 2011 National Occupational Research Agenda (NORA) Manufacturing Sector Conference, Cincinnati, Ohio, September 7–8.



## **Project 58: Applying PtD to the Safe Handling of Engineered Nanomaterials**

**Principle Investigators:** Donna Heidel, CIH, and Charles Geraci, PhD, CIH

**Project Duration:** FY 2009–2013

**Critical Topic Areas:** Engineering controls, recommendations, and guidance

### **Accomplishments and Research Findings**

- Statement of work developed to support drafting the Nanotechnology Prevention through Design (PtD) workshop agenda and expected outcomes. Workshop to be held in 2012.
- Contract awarded.
- Contractor has developed stakeholder questionnaire to provide information for agenda development.

### **Publications**

- None

### **Invited Presentations**

- None



## Project 59: Penetration of Nanoparticles Through Respirators/Development of Respirator Filtration Test Methods

**Principle Investigator:** Samy Rengasamy, PhD

**Project Duration:** FY 2005–2011

**Critical Topic Areas:** Engineering controls and personal protective equipment

### Accomplishments and Research Findings

- Developed and constructed novel test systems and methods to measure filter penetration and face seal leakage with a breathing manikin system.
- Conducted studies to measure nanoparticle penetration through filter materials and face seal leakage, and evaluated particle number-based and photometric test methods to measure filter penetrations through the following types of devices/materials:
  - NIOSH-approved N, R, and P series filtering facepiece respirators (FFRs) of classes 95, 99, and 100
  - FDA-cleared surgical masks
  - Dust masks available in home improvement/hardware stores
  - Cloth masks available in beauty and personal care stores
  - Commonly used clothing materials
- Key findings from these studies included the following:
  - N95 FFR penetrations measured by a particle number-based (count-based) method were two to six times greater than the levels measured by a photometric method (TSI 8130), when tested with the same aerosols employed in the NIOSH respirator certification method. Filtration test methods using photometric detection lack sensitivity for particles <100 nm in size.
  - As expected, NIOSH-approved N95 and P100 air-purifying respirators have more consistent levels of filtration performance against nanoparticles than dust masks, FDA-cleared surgical masks, or cloth masks/commonly used clothing materials. NIOSH-approved N95 and P100 FFRs had similar levels of nanoparticle filtration performance as their CE-marked counterparts (FFP2 and FFP3).
  - Respirator total inward leakage (TIL) increased with increasing leak sizes, demonstrating the need for using a good-fitting respirator. However, with



relatively small leaks, TIL measured for 50-nm-size particles was about two-fold higher than the values for 8- and 400-nm-size particles.

- NIOSH-approved respirators should provide levels of performance consistent with their OSHA-assigned protection factors (APF). Thus, current NIOSH tools for respirator selection can be used. However, employers may wish to factor in particle size during the respirator selection process. This could be accomplished by choosing a different type of respirator, offering higher levels of protection (i.e., higher APF), or by choosing a particulate respirator with a higher filtration rating (e.g., switching from N95 to N100 series).
- Collaborated with IRSST, Canada, and Lovelace Respiratory Research Institute, NM, on nanoparticle filtration research projects.
- Research findings from the work have been cited in nanotechnology documents, including those of NIOSH, IOM, IRSST, EU-OSHA, Edinburgh Napier University Report, Safe Work Australia, and ISO-TC. CDC highlighted one of the publications in the Science Clips in This Week's top scientific articles.



Nanomaterial worker wearing a half face elastomeric respirator with p100 cartridges

## Publications and Abstracts

- Rengasamy S, Verfobsky R, King W, Shaffer R [2007]. Nanoparticle penetration through NIOSH-approved N95 filtering facepiece respirators. *JISRP* 24:49–59.
- Rengasamy S, Eimer B, Shaffer R [2008]. Nanoparticle filtration performance of commercially available dust masks. *JISRP* 25:27–41.
- Rengasamy S, King W, Eimer B, Shaffer R [2008]. Filtration performance of NIOSH-approved N95 and P100 filtering facepiece respirators against 4–30-nanometer-size nanoparticles. *JOEH* 5:556–564.
- Shaffer R, Rengasamy S [2009]. Respiratory protection against nanoparticles: a review. *J Nanopart Res* 11:1661–1672.
- Rengasamy S, Eimer B, Shaffer R [2009]. Comparison of nanoparticle filtration performance of NIOSH-approved and CE-marked particulate filtering facepiece respirators. *Ann Occup Hyg* 53:117–128.
- Shaffer R, Rengasamy S [2009]. Respiratory protection against nanoparticles: a review. *J Nanopart Res* 11:1661–1672.
- Rengasamy S, Eimer B, Shaffer R [2009]. Filtration performance of FDA-cleared surgical masks. *J Int Soc Res Prot* 26:54–70.
- Rengasamy S, Zhuang Z, Roberge R, Shaffer R [2010]. Particulate respiratory protection: overview, emerging issues and research needs. In: Argosyan VE, ed. *Protective devices: types, uses and safety*. Hauppauge, New York: Nova Science Publishers, Inc., pp. 131–160.
- Rengasamy S, Eimer B, Shaffer R [2010]. Simple respiratory protection: evaluation of the filtration performance of cloth masks and common fabric materials against 20–1000 nm size particles. *Ann Occup Hyg* 54:789–798.
- Rengasamy S, Eimer B, Miller A [2010]. Effects of organic solvents on the laboratory filtration performance of N95 and P100 filtering facepiece respirators. *J Int Soc Res Prot* 27:53–64.
- Rengasamy S, Miller A, Eimer B [2011]. Evaluation of the filtration performance of NIOSH-approved N95 filtering facepiece respirators by photometric and number-based test methods. *J Occup Environ Hyg* 8:23–30.
- Rengasamy S, Eimer B [2011]. Total inward leakage of nanoparticles through filtering facepiece respirators. *Ann Occup Hyg* 55:253–263.
- Rengasamy S, Eimer B [2012]. Nanoparticle filtration performance of NIOSH certified particulate air purifying filtering facepiece respirators: evaluation by light scattering photometric and particle number-based test methods. *J Occup Environ Hyg* 9(2):99–109, DOI: 10.1080/18459624.2011.642703.
- Rengasamy S, Eimer B [2012]. Nanoparticle penetration through filter media and leakage through face seal interface of N95 filtering facepiece respirators. *Ann Occup Hyg* Jan 31, DOI:10.1093/annhyg/mer122.



## Invited Presentations

- Shaffer R [2007]. Air purifying respirators for the nanotechnology industry. National Response Team—Worker Safety and Health Conference, Washington, DC, August 7.
- Shaffer R [2007]. An overview of NIOSH nanotechnology research and an update on the efficacy of personal protective equipment for reducing worker exposure to nanoparticles. Commercialization of Nanomaterials Meeting, Pittsburgh, Pennsylvania, November 11–13.
- Rengasamy S, Eimer B, Shaffer R [2008]. Filtration performance of NIOSH-approved N95 and P100 filtering facepiece respirators against nanoparticles. American Industrial Hygiene Association Conference, Minneapolis, Minnesota, May 31–June 5.
- Rengasamy S, Eimer B, Shaffer R [2008]. Comparison of nanoparticle filtration performance of NIOSH-approved and European-certified filtering facepiece respirators. ISRP International Conference, Dublin, Ireland, September 14–18.
- Rengasamy S, Eimer B, Shaffer R [2008]. Comparison of nanoparticle filtration performance of NIOSH-approved and European-certified filtering facepiece respirators. American Association for Aerosol Research Annual Conference, Orlando, Florida, October 20–24.
- Rengasamy S, Shaffer R [2007]. Respiratory protection against nanoparticles. Chesapeake Area Biological Association Scientific Symposium, Columbia, Maryland, June 14.
- Shaffer R [2008]. Effectiveness of personal protective equipment and engineering controls. Safe Handling of Engineered Nanoscale Materials Symposium, Argonne, Illinois, July 7 and 8.
- Shaffer R [2008]. Control and filtration of nanomaterials. Occupational Health Aspects of Nanotechnology Symposium. Northern California Section of the American Industrial Hygiene Association, Menlo Park, California, May 14.
- Rengasamy S [2008]. Respiratory protection against biological and inert particles. International Society for Respiratory Protection Meeting on Respiratory Protection Issues in Emergency Response and Healthcare, Montreal, Canada, October 6.
- Rengasamy S [2008]. Respiratory protection against nanoparticles. Institut de Recherche en Sante et en Securite du Travail, Colloquium on Respiratory Protection: Research Priorities, Montreal, Canada, October 7.
- Rengasamy S, Eimer B [2009]. Nanoparticles leakage around face/mask interface of filtering facepiece respirators. American Industrial Hygiene Conference and Exposition, Toronto, Canada. May 30–June 5.

- Shaffer RE, Hoover M [2009]. Effectiveness of personal protective equipment (PPE) and engineering controls for nanomaterials. American Chemical Society National Meeting and Exposition, Salt Lake City, Utah, March 22–26.
- Shaffer RE [2009]. Personal protective equipment and filtration [2009]. EH&S Challenges of the Nanotechnology Revolution Workshop, The Molecular Foundry, Lawrence Berkeley National Laboratory, Berkeley, California, July 29.
- Shaffer RE [2009]. Respiratory protection against emerging hazards. Keynote speaker for the ERC Pilot Symposium at the University of Cincinnati, Cincinnati, Ohio, October 1–2.
- Rengasamy S, Eimer B [2010]. Total inward leakage of nanoparticles through filtering facepiece respirators. International Society for Respiratory Protection, Hong Kong, China, September 26–30.
- Shaffer RE [2010]. Towards improved personal protective equipment: possible applications for nanofibers? Nanofibers for the 3rd Millennium–Nano for Life™—2010 Conference, Raleigh Marriott City Center, Raleigh, North Carolina, August 30.
- Rengasamy S, Eimer B [2011]. Evaluation of filtration performance of NIOSH-approved particulate air purifying filtering facepiece respirators. American Industrial Hygiene Conference and Exposition, Portland, Oregon, May 14–19.
- Rengasamy S, Eimer B [2011]. Advances in respiratory protection and personal protective equipment. American Industrial Hygiene Conference and Exposition, Portland, Oregon, May 14–19.
- Rengasamy S, Eimer B, Shaffer R [2011]. Respiratory protection against nanoparticles. NSF Nano Workshop, University of Massachusetts, Lowell, Massachusetts, August 10–12.
- Rengasamy S [2011]. Respiratory protection against nanoparticles. NSF Nano Workshop. University of Central Florida, Orlando, Florida, December 9–10.



## Project 60: Nanoparticle Penetration through Protective Clothing

**Principle Investigator:** Pengfei Gao, PhD, CIH

**Project Duration:** FY 2009–2010

**Critical Topic Areas:** Engineering controls and personal protective equipment

### Accomplishments and Research Findings

- The project was focused on the design and characterization of a method simulating typical wind-driven conditions for evaluating the performance of materials used in the construction of protective clothing. Ten nonwoven fabrics were selected, and physical properties including fiber diameter, fabric thickness, air permeability, porosity, pore volume, and pore size were determined. Particle penetration levels were measured under different face velocities and compared with a filtration-based method using the TSI 3160 automated filter tester.
- Our research findings show that particle penetration increased with increasing face velocity, and penetration also increased with increasing particle size up to about 300 to 500 nm. Penetrations measured by the wind-driven method were lower than those obtained with the filtration method for most of the fabrics selected, and the relative penetration performances of the fabrics were very different due to the vastly different pore structures.
- Particle penetration data from this study can be used to improve NIOSH guidance on the penetration of nanoparticles through protective clothing and ensembles.
- The research findings could be used by government agencies, standards development organizations, and professional organizations to improve and/or develop scientifically appropriate guidance documents, protective clothing performance requirements, and test methods.

### Publications and Abstracts

- Gao P, Jaques PA, Hsiao TH, Shepherd A, Eimer B, Yang M, Miller A, Gupta B, Shaffer R [2011]. Evaluation of nano- and sub-micron particle penetration through ten nonwoven fabrics using a wind-driven approach. *J Occup Environ Hyg* 8(1):13–22.

### Invited Presentations

- Gao P, Jaques PA, Shaffer R, Yang M, Shepherd A [2010]. A wind-driven method to assessing nano- and sub-micron particle penetration through fabrics. Presented at the American Industrial Hygiene Conference & Exposition, Denver, Colorado, May 22–27, 2010. Received Best Poster of the Section Award.

## Project 61: Respirator Performance Against Engineered Nanoparticles Under Laboratory and Workplace Settings

**Principle Investigator:** Ziqing Zhuang, PhD

**Project Duration:** FY 2011–2015

**Critical Topic Areas:** Engineering controls and personal protective equipment; exposure assessment

### Accomplishments and Research Findings

- A NIOSH Science Blog on Respiratory Protection and Nanoparticles was developed and posted in December 2011 (<http://blogs.cdc.gov/niosh-science-blog/category/respiratory-health/>). This science blog summarizes the science and rationale behind NIOSH's recommendations for the use and selection of respirators against engineered nanoparticles.
- A study protocol, titled Respirator Performance Against Engineered Nanoparticles Under Laboratory and Workplace Settings, has been developed and peer-reviewed. The protocol has been approved by the NIOSH human subject review board and data collection will begin in 2012.
- Pilot laboratory studies were initiated while the full protocol was being drafted, reviewed, and approved. These pilot studies investigated the leak behavior of nanoparticles, analyzed previously collected human subject data on respirator fit, and measured the filtration performance of NIOSH approved respirators against carbon nanotubes. Key findings from these pilot studies include the following:
  - Nanoparticle penetration through manufactured leaks in electret media may be significantly reduced when compared to mechanical media and theory. The theoretical model was modified to achieve good agreement with experimental results for electret media. Future studies done under breathing conditions using manikins are needed to validate the revised model with fitting parameters to better understand nanoparticle leak behavior.
  - Nanoparticle fit factors obtained from N95 filtering facepiece respirators (FFRs) donned by human subjects were the same or higher than fit factors obtained from human subjects tested using to a more diverse particle size range. This preliminary data suggests that respirator leakage for nanoparticles should be similar to leakage levels found during typical respirator fit testing.





- With use of a custom-designed carbon nanotube aerosol respirator testing system, the filtration performance of NIOSH-approved N95, N99, and P100 series FFRs was measured. The results indicated that different FFR models yielded different levels penetrations. As expected, P100 FFRs had the highest levels of filtration performance, followed by N99 series and N95 series FFRs.

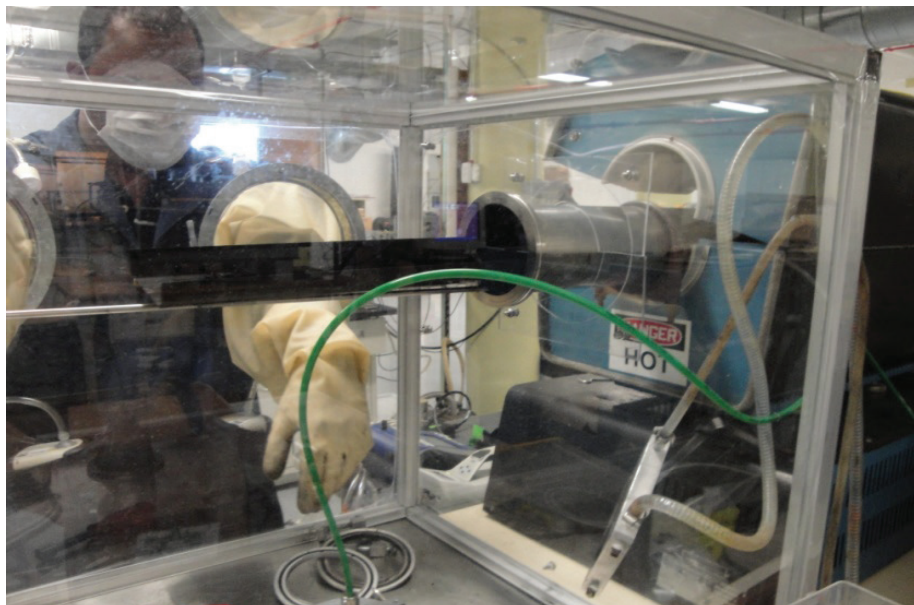

Personal protective equipment and controls used by nanomaterial workers

## Publications

- None

## Invited Presentations

- Zhuang Z, Bergman M, Eimer B, Shaffer R, BerryAnn R [2011]. Laboratory fit evaluation of N95 filtering facepiece respirators against nanoparticles and “all size” particles. Poster presentation at the 5th International Symposium on Nanotechnology, Occupational and Environmental Health, Boston, Massachusetts, August 9–12.
- Zhuang Z, Bergman M, Eimer BC, Shaffer RE [2011]. Laboratory fit evaluation of N95 filtering facepiece respirators against nanoparticles and “all size” particles. Oral presentation at the ISRP Americas Section Annual General Meeting, St. Paul, Minnesota, September 11–12.
- Pearce T, Fries M, Zhuang Z [2012]. Behavior of nanoparticle penetration through simulated filtering facepiece respirator face seal leaks: experiment and theory. Abstract accepted for an oral presentation at the American Industrial Hygiene Association Conference & Expo, Indianapolis, Indiana, June 17–21.



## Project 62: Development of Personal Protective Equipment Ensemble Test Methods

**Principle Investigator:** Pengfei Gao, PhD, CIH

**Project Duration:** FY 2005–2012

**Critical Topic Areas:** Engineering controls and personal protective equipment

### Accomplishments and Research Findings

- Developed and evaluated a multidomain magnetic passive aerosol sampler for measuring particulate penetration through protective ensembles. Submitted an employee invention report to CDC Technology Transfer Office (Ref. #I-007-08; Gao P [2007]). The new sampler significantly enhances collection of magnetically susceptible particles, simulates the user's real situation in the workplace better than alternative filtration-based approaches, and is promising for determining particle penetration through protective clothing materials.
- Developed and constructed a recirculation aerosol wind tunnel (RAWT) for evaluating aerosol samplers and measuring particle penetration through protective clothing materials. The RAWT is able to maintain relatively constant aerosol concentrations within a wide range of wind velocities and minimizes costs associated with conventional single-pass tunnels for our research needs.

### Publications and Abstracts

- Gao P, King WP, Shaffer R [2007]. Review of chamber design requirements for testing of personal protective clothing ensembles. *J Occup Environ Hyg* 4(8):562–571.
- Jaques PA, Hsiao TH, Gao P [2011]. A recirculation aerosol wind tunnel for evaluating aerosol samplers and measuring particle penetration through protective clothing materials. *Ann Occup Hyg* 55(7):784–796.
- Gao P, Jaques PA, Hsiao TH, Shepherd A, Eimer B, Yang M, Miller A, Gupta B, Shaffer R [2011]. Evaluation of nano- and sub-micron particle penetration through ten nonwoven fabrics using a wind-driven approach. *J Occup Environ Hyg* 8(1):13–22.
- Jaques PA, Hopke PH, Gao P [2012]. Quantitative analysis of uniquely distributed submicron paramagnetic Fe<sub>3</sub>O<sub>4</sub> particles using computer controlled scanning electron microscopy. *Aerosol Sci Technol* 46(8):905–912.
- Gao P, Jeffrey LB, Shaffer R [2011]. Considerations for selection of PPE to protect against nanoparticle exposure. In: Anna D, ed. *Chemical protective clothing*. 3rd ed. Fairfax, Virginia: AIHA [in press].

- Hsiao TH, Jaques PA, Gao P [2011]. Multi-domain magnetic passive aerosol sampler, part I: design and principle of operation. *Aerosol Sci Technol* [submitted].
- Hsiao TH, Jaques PA, Li L, Lee CN, Gao P [2011]. Multi-domain magnetic passive aerosol sampler, part II: experimental evaluation of the performance. *Aerosol Sci Technol* [submitted].

### Invited Presentations

- Wang ZM, Gao P [2007]. A study on magnetic passive aerosol sampler for measuring aerosol particle penetration through protective ensembles. American Association for Aerosol Research Annual Conference, Reno, Nevada, September 24–28.
- Shaffer R [2007]. An overview of NIOSH nanotechnology research and an update on the efficacy of personal protective equipment for reducing worker exposure to nanoparticles. Commercialization of Nanomaterials Meeting, Pittsburgh, Pennsylvania, November 12.
- Shaffer R [2008]. Control and filtration of nanomaterials. Occupational Health Aspects of Nanotechnology Symposium, Northern California Section of the American Industrial Hygiene Association, Menlo Park, California, May 14.
- Shaffer R [2008]. Effectiveness of PPE and engineering controls. Safe Handling of Engineered Nanoscale Materials Symposium, Argonne, Illinois, July 7 and 8.
- Jaques PA, Gao P [2008]. Effect of wind velocity on particle collection using a multi-domain magnetic passive aerosol sampler. Presented at the American Association for Aerosol Research (AAAR) 27th Annual Conference, Orlando, Florida, October 20–24.
- Hsiao TC, Jaques PA, Gao P [2010]. Development of a multi-domain magnetic passive aerosol sampler for measuring particle penetration through personal protective ensembles. Presented at the American Association for Aerosol Research (AAAR) 29th Annual Conference, Portland, Oregon, October 25–29.
- Gao P, Jaques PA, Shaffer R, Yang M, Shepherd A [2010]. A wind-driven method to assessing nano- and sub-micron particle penetration through fabrics. Presented at the American Industrial Hygiene Conference & Exposition, Denver, Colorado, May 22–27.
- Gao P, Jaques PA [2011]. Investigation of Fe<sub>3</sub>O<sub>4</sub> particle deposition pattern on an individual magnet of a multi-domain magnetic passive aerosol sampler. Presented at the 5th International Symposium on Nanotechnology: Occupational and Environmental Health, Boston, Massachusetts, August 9–12.



- Gao P, Jaques PA, Hopke PH [2011]. Quantitative analysis of uniquely distributed submicron paramagnetic  $\text{Fe}_3\text{O}_4$  particles using computer controlled scanning electron microscopy. Presented at the American Industrial Hygiene Conference & Exposition, Portland, Oregon, May 14–19.

## Project 63: Explosibility and Flammability of Carbon Nanotubes

**Principle Investigator:** Leonid A. Turkevich, ScD

**Project Duration:** FY 2010–2013

**Critical Topic Areas:** Fire and explosion

### Accomplishments and Research Findings

- Explosion testing performed on 20 codes of carbonaceous particles (including single-walled and multi-walled carbon nanotubes, carbon nanofibers, graphene, diamond, fullerene, carbon blacks, graphites).
  - Typical overpressure  $p \sim 5\text{--}7$  bar, deflagration index  $KSt \sim 10\text{--}80$  bar-m/s (i.e., St-1, similar to cotton and wood dust).
  - Explosive parameters uncorrelated with particle size.
- Selected additional analyses identified minimum explosive concentration (MEC)  $\sim 101\text{--}102$  g/m<sup>3</sup> (order of magnitude lower than coals).
- Concentration scans yielded higher over-pressures and deflagration indices; e.g., fullerene is borderline St-1/St-2.
- Powder conductivity (which shorted out the electrical ignition) raised additional safety concern of using these materials in the presence of electrical equipment.
- Investigated dustiness of many fine and nanoscale powders (including single-walled and multi-walled carbon nanotubes, carbon nanofibers, carbon blacks).
  - Respirable and total dustiness spanned two orders of magnitude.

### Publications

- Evans DE, Turkevich LA, Roettgers CT, Deye GJ, Baron PA [2012]. Dustiness of fine, nanoscale powders. *Ann Occup Hyg* doi 10.1093/annhyg/mes060.

### Invited Presentations

- Evans DE, Ku BK, Birch ME, Dunn KH, Turkevich LA [2010], Differentiating workplace aerosol emissions by direct-reading instrumentation. International Conference on Workplace Aerosols, Karlsruhe, Germany, June 28–July 2.
- Turkovich LA [2010]. Explosibility of carbonaceous nanoparticles. NIOSH Nanotechnology Research Center (NTRC) Review Meeting, Oglebay, Wheeling, West Virginia, April 19–21.



- Turkevich LA [2010]. Potential explosive hazard of carbonaceous nanoparticles. NIOSH Intramural Science Conference, Salt Fork, Ohio, August 10.
- Evans DE, Turkevich LA, Roettgers CT, Deye GJ, Baron PA [2011]. Dustiness of nanomaterials. American Industrial Hygiene Conference, Portland, Oregon, May 14–19.
- Turkevich LA, Dastidar A, Fernback J [2011]. Potential explosive hazard of carbonaceous nanoparticles. 5th International Conference on Nanotechnology Occupational and Environmental Health, Boston, Massachusetts, August 10–12.
- Evans DE, Turkevich LA, Roettgers CT, Deye GJ, Baron PA [2011]. Dustiness of nanomaterials. 5th International Conference on Nanotechnology Occupational and Environmental Health, Boston, Massachusetts, August 10–12.
- Turkevich LA, Fernback JE, Dastidar AG [2011]. Potential explosive hazard of carbonaceous nanoparticles. 2011 NORA Manufacturing Sector Conference, Cincinnati, Ohio, September 7–8.
- Evans DE, Turkevich LA, Roettgers CT, Deye GJ, Baron PA [2011]. Dustiness of nanomaterials. 30th AAAR Annual Conference, Orlando, Florida, October 3–7.
- Turkevich LA [2011]. Potential explosive hazard of carbonaceous nanoparticles. Technical seminar, NIOSH/DART Exposure Sciences Research (EXPSR) Program Science Exposition, Cincinnati, Ohio, September 21.



Explosion testing of carbon nanotubes



## Project 64: Current Intelligence Bulletin: Carbon Nanotubes and Carbon Nanofibers

**Principle Investigators:** Eileen Kuempel, PhD; Vincent Castranova, PhD; Douglas Trout, MD; and Eileen Birch, PhD

**Project Duration:** FY 2009–2014

**Critical Topic Area:** Recommendations and guidance

### Accomplishments and Research Findings

- A draft Current Intelligence Bulletin (CIB) was prepared, describing the risk of potential adverse respiratory effects from exposure to carbon nanotubes and nanofibers. Risk management strategies were provided to minimize health risks to exposed workers, including a recommended exposure limit (REL).
- A NIOSH Nanotechnology Research Center (NTRC) review of the CIB was conducted, and a revised draft of the CIB was prepared for external review.
- A Federal Register Notice was prepared and published in December 2010, announcing the release of the draft CIB for public and stakeholder review.

### Publications

- Kuempel ED [2011]. Carbon nanotube risk assessment: implications for exposure and medical monitoring. *J Occup Environ Med* 53(6)(Suppl):S91–S97.
- Kuempel E, Castranova V [2011]. Hazard and risk assessment of workplace exposure to engineered nanoparticles: methods, issues, and carbon nanotube case study. In: Ramachandran G, ed. *Assessing nanoparticle risks to human health*. Micro & Nano Technologies Series. Boston: William Andrew Publishing, pp. 65–97.

### Invited Presentations

- Kuempel E [2009]. Risk assessment case study: carbon nanotubes. Organization for Economic Cooperation and Development (OECD) Workshop on Risk Assessment of Manufactured Nanomaterials in a Regulatory Context, Washington, DC, September 17.
- Kuempel E [2010]. Carbon nanotube risk assessment: implications for medical screening. *Nanomaterials and Worker Health: Medical Surveillance, Exposure Registries, and Epidemiological Research*, Keystone, Colorado, July 21–23.



- Kuempel E [2010]. Carbon nanotube risk assessment: using toxicology data to develop RELs. NIOSH Intramural Science Conference, Salt Fork, Ohio, August 10–11.
- Kuempel E, Zumwalde R [2010]. Risk assessment of carbon nanotubes and status of NIOSH current intelligence bulletin. NTRC 2010 Update, Wheeling, West Virginia, April 20.
- Kuempel E [2011]. Risk assessment of carbon nanotubes. NIOSH Public Review Meeting on the Draft Current Intelligence Bulletin on Occupational Exposure to Carbon Nanotubes and Nanofibers, Cincinnati, Ohio, February 3.
- Kuempel E [2011]. Occupational health risk assessment and CNT case study. Guest lecture in a graduate course at the University of Michigan, Ann Arbor, Michigan, March 24.
- Kuempel ED [2011]. Methods and uncertainties in carbon nanotube risk assessment. Society for Risk Analysis Annual Meeting, Charleston, South Carolina, December 5.
- Kuempel ED, Geraci CL [2011]. NIOSH draft current intelligence bulletin: occupational exposure to carbon nanotubes and nanofibers. Society for Chemical Hazard Communication (SCHC) Fall Meeting, Arlington, Virginia, October 4.
- Schulte PA [2011]. Overview of the draft NIOSH current intelligence bulletin: occupational exposure to carbon nanotubes and nanofibers. Nanotechnology Environmental Health Implications Working Group, Washington, D.C., January 20.
- Schulte P, Kuempel E, Zumwalde R, Geraci C, Schubauer-Berigan M, Castanova V, Hodson L, Murashov V, Ellenbecker M [2011]. Focused actions to protect carbon nanotube workers. The 5th International Symposium on Nanotechnology Occupational and Environmental Health, Boston, Massachusetts, August 10–12.

## Project 65: Assessing the Utility of Control Banding in the U.S.

**Principal Investigator:** T.J. Lentz, PhD

**Project Duration:** FY 2004–2012

**Critical Topic Areas:** Recommendations and Guidance

### Accomplishments and Research Findings

- Coordinated a conference on Control Banding in the United States: This conference/workshop assembled national experts and stakeholders to discuss a national control banding plan and agenda (Washington, DC, March 2005)
- Coordinated Intercontinental Workshop on the Occupational Safety and Health Toolkit. This event demonstrated the opportunities for international linkages to promote control banding strategies in developing and developed nations alike. This program promoted acceptance of the Global Implementation Strategy for control banding with effective demonstration of control-focused solutions observed simultaneously at two international scientific venues on different continents (Johannesburg, South Africa and Orlando, FL, September 2005).
- Completed NIOSH Control Banding Topic Page—The topic page provides a focal point for the Institute’s control banding effort, conveying information and resources to and from multiple global sources.
- Control Banding Letter of Agreement—This component leveraged resources of NIOSH, U.K. HSE, and OSHA in coordinating efforts to develop and promote control banding solutions to occupational safety and health challenges and shared priorities.
- Outreach in training efforts in FY07 and FY08 included workshops in Chile and India coordinated by NIOSH and the World Health Organization (WHO) to present concepts and control-focused solutions for exposures to silica and other hazards in the workplace.

### Publications and Abstracts

- Qualitative Risk Characterization and Management of Occupational Hazards: Control Banding (CB). DHHS (NIOSH) Publication No. 2009–152.

### Invited Presentations

- Lentz TJ, Beaucham C [2009]. Chemical control banding. Ohio Safety Congress, Columbus, OH, April 1.



- Lentz TJ [2009]. Practical use of control banding for qualitative risk assessment and management of occupational hazards. ORC Worldwide Joint Conference of Occupational Physicians and Safety and Health Groups, Washington, DC, February 3–4.
- Lentz TJ [2008]. Control banding: Qualitative risk assessment and management approaches for chemical exposures. Joint EFCOG/DOE Chemical Safety and Lifecycle Management Workshop, Washington, DC, March 4–6.
- Lentz TJ [2007]. Control banding (bandas de controles): Qualitative occupational risk assessment and management using control-focused solutions and guidance. Control Banding Workshop, Chilean Institute of Public Health, Santiago, Chile, South America, July 17–19.
- Lentz TJ [2007]. Control banding (bandas de controles): Applications for silica and silicosis prevention. Control Banding Workshop, Chilean Institute of Public Health, Santiago, Chile, South America, July 17–19.
- Lentz TJ [2007]. Investigating the merits of control banding for workplace chemical hazards. Panel session at the Second Control Banding Workshop, University of Connecticut Health Center, Hartford, CT, February 1.
- Lentz TJ (arranger), Miller J, Hildreth Watts C [2006]. Introduction to control banding—The GTZ Chemical Risk Management Guide and Training. Kentucky Governor’s Safety and Health Conference, Louisville, KY, May 9–12.
- Lentz TJ [2009]. National efforts to explore control-focused solutions and their application. 48th Navy and Marine Corps Public Health Conference, Hampton, VA, March 25.

## **Project 66: Web-based Nanoparticle Information Library Implementation**

**Principal Investigator:** Arthur Miller, PhD, and Mark Hoover, PhD

**Project Duration:** FY 2004–2008

**Critical Topic Areas:** Communication and information

### **Accomplishments and Research Findings**

- Collaborated with Oregon State University and a Health Effects Institute (HEI) consortium toward the development of an informational hub for nanotechnology and health effects.
- Developed Web-links for the NIOSH Nanoparticle Information Library to online resources at the Wilson International Center for International Scholars, the International Council on Nanotechnology bibliography on nanotechnology safety and health at Rice University, and the National Science Foundation's Nanomanufacturing Network at the University of Massachusetts at Lowell.
- Continued input for redesigning the nanotechnology topic page on the NIOSH Web site.
- Developed a prototype portable, hand-held electrostatic precipitator that would enhance development of new information for the Nanoparticle Information Library by enabling nanoparticle sampling and subsequent electron microscopy analysis.
- Developed protocols for analysis of workplace nanoaerosol samples, using transmission electron microscopy/energy dispersive spectroscopy.
- Developed a protocol for nanoaerosol characterization fieldwork, including quasi-real time spatial-mapping of nanoparticle concentrations in the workplace.
- Updated Nanoparticle Information Library software to meet new CDC security requirements.
- Incorporated a mailing interface and a newsletter interface in the design of the Nanoparticle Information Library.
- Developed online newsletters and disseminated them to persons on the Nanoparticle Information Library mailing list.
- Applied content of the Nanoparticle Information Library in development of a course entitled Nanotechnology Science and Engineering for the mechanical engineering department at Gonzaga University. The course covers the basic chemical, physical, and engineering principles governing nanomaterials,



highlighting their differences from classic materials, as well as the science required to use them in nanotechnologies for real-world problem solving.

- Led a team of students in the design, building, and testing of a rapid mobility particle sizer, which has application for the Nanoparticle Information Library and nanotechnology science in general and won first place in the 2008 American Society of Mechanical Engineers (ASME) national design contest.
- During FY2009–FY2010, activities on the Nanoparticle Information Library (NIL) initiated in this project were advanced through work in the NTRC project on Nanoparticles in the Workplace and Metrics for Field and Toxicity Studies. The NIL can be accessed at [www.nanoparticlelibrary.net](http://www.nanoparticlelibrary.net).

### Publications and Abstracts

- Miller AL, Hoover MD, Mitchell DM, Stapleton BP [2007]. The nanoparticle information library (NIL): a prototype for linking and sharing emerging data. *J Occup Environ Hyg* 4(12):D131–D134.
- Miller AL, Stipe C, Habjan MC, Ahlstrand G [2007]. Role of lubrication oil in particulate emissions from a hydrogen-powered internal combustion engine. *Environ Sci Technol* 41:6828–6835.
- Miller A, Ahlstrand G, Kittelson DB, Zachariah MR [2007]. The fate of metal (Fe) during diesel combustion: morphology, chemistry, and formation pathways of nanoparticles. *Combust Flame* 149:129–143.
- Miller AL, Habjan MC, Park K [2007]. Real-time estimation of elemental carbon emitted from a diesel engine. *Environ Sci Technol* 41:5783–5788.
- Ng A, Miller A, Ma H, Kittelson DB [2007]. Comparing measurements of carbon in diesel exhaust aerosols using the aethalometer, NIOSH method 5040 and SMPS. SAE Tech Paper Series 2007-01-0334.
- Miller AL, Habjan M, Beers-Green A, Ahlstrand G [2008]. Microscopic analysis of airborne particles and fibers. In: *American Conference of Governmental Industrial Hygienists Handbook. Air Sampling Technologies: Principles and Applications*. Cincinnati, OH: American Conference of Governmental Industrial Hygienists.
- Park K, Kim J-S, Miller AL [2008]. A study on effects of size and structure on hygroscopicity of nanoparticles using a tandem differential mobility analyzer and transmission electron microscopy. *J Nanopart Res* 11(1):175–183.
- Choo S-W, Lee D, Lee K-S, Miller AL, Park K, Zachariah M, Zhou L [2008]. Understanding nanoscale phenomena using single particle mass spectrometry and improvement of its performance—a review. *Chem Physics Res J* 2(1/2):1–37.

## Invited Presentations

- Hoover MD, Miller AL, Lowe NT, Stefaniak AB, Day GA, Linch KD [2004]. Information management for nanotechnology safety and health. 1st International Symposium on Nanotechnology and Occupational Health, Buxton, UK, October 11–14.
- Hoover MD [2005]. NIOSH nanotechnology informatics overview. NIOSH–Altair Nanotechnologies, Inc., Information Exchange Meeting, Reno, Nevada, April 19.
- Hoover MD [2005]. Informatics for nanotechnology safety and health: round table on the role of the occupational safety and health professional in the emerging nanotechnology industry. American Industrial Hygiene Conference and Exposition, Anaheim, California, May 24.
- Miller AL, Hoover MD [2006]. Building a nanoparticle information library. National Occupational Research Agenda Symposium, Washington, DC, April 18–20.
- Miller A [2007]. Occupational safety and health challenges of nanotechnology: what we know and what we don't know. Oregon Governor's Occupational Health and Safety Conference, Portland, Oregon, March 13.
- Miller A [2007]. Characterization of hazardous pollutants in the workplace. IERC Workshop for Sound Management of Hazardous Chemicals and Sustainable Energy, Sponsored by the Gwangju Institute of Science and Technology, Gwangju, Korea, October 30–November 3.
- Miller A [2008]. Spatial mapping of industrial hygiene data in the workplace. American Industrial Hygiene Association Conference and Exhibition, Minneapolis, Minnesota, May 31–June 5.
- Miller A, Geraci CL, Maynard A [2008]. NIOSH's role in improving health and safety in nanotechnology workplaces. Special Libraries Association Annual Meeting, Seattle, Washington, June 15–17.
- Miller A [2008]. NIOSH's role in improving health and safety in nanotechnology workplaces: knowledge management of nanotechnology information. Micro-Nano Breakthrough Conference, Portland, Oregon, September 8–10.





## Project 67: Nanoparticles in the Workplace and Metrics for Field and Toxicity Studies

**Principle Investigator:** Mark D. Hoover, PhD

**Project Duration:** FY 2004–2011

**Critical Topic Areas:** Communication and information; exposure assessment and measurement

### Accomplishments and Research Findings

- Summarized and published issues and approaches for exposure assessment of nanoparticles in the workplace, as a chapter in a book on nanotoxicology that involved a spectrum of international contributors. The exposure assessment chapter included a comprehensive formulaic method for assessing and managing determinants of workplace exposure such as material at risk, damage ratio, airborne release fraction, respirable fraction, and control factors.
- Contributed to the development of an American Industrial Hygiene Association document on guidance for conducting control banding analyses. Provided leadership in activities of the American Industrial Hygiene Association control banding working group and the American Industrial Hygiene Association nanotechnology working group to develop potential nanotechnology applications of control banding approaches from pharmaceutical and other historical experiences.
- Developed a new ultrafine beryllium oxide standard reference material (SRM) through collaborations with the National Institute of Standards and Technology (NIST) and U.S. Department of Energy (DOE). SRM 1877 was formally approved and issued for distribution and use in August 2008. This is one of the first reference materials issued in the ultrafine particle size range and will improve calibration and development of sampling and analytical methods and toxicity testing. Round-robin evaluations of analytical methods for beryllium detection in air filtration samples spiked with SRM 1877 are under way, under the auspices of the Beryllium Health and Safety Committee. Results of the evaluations are expected to have relevance for digestion and detection efficiencies of other ultrafine metal oxide particles.
- Provided leadership in a multi-organizational group of experts to develop an improved industrial hygiene decision-making framework (Anticipate, Recognize, Evaluate, Control, and Confirm) to provide a stronger basis for guidance for conducting control banding analyses by ensuring that measurements and epidemiology are conducted to confirm the efficacy of control.
- Conducted filtration performance tests and comparisons with field experience for filtration behavior of ultrafine particles and incorporated the results

into scientific presentations and in a book chapter on filtration. The chapter includes exposure assessment guidance for characterizing and managing particles of all sizes.

- Led national experts in development of new ANSI consensus standards for calibration of air monitoring instruments used for airborne particles, including those in the nanometer size range.
- Collaborated in conducting and publishing the results of experimental investigations into the production and characteristics of aerosol releases from a number of scenarios, including disruption of uranium in high-energy environments and melting and vaporization of metals in advanced welding techniques.
- Helped organize and worked with a group of national experts on development of a standard file format for data submission and exchange on nanomaterials and characterizations.
- Worked in conjunction with Oregon State University's Knowledgebase of Nanomaterial-Biological Interactions to reestablish open web-based access to NIOSH Nanoparticle Information Library (NIL) and collaborated with the National Institute for Biomedical Imaging and Bioengineering to establish a Nanomaterials Registry at Research Triangle Institute. An initial focus of the new registry was the incorporation of data from the NIL.
- Helped organize and conduct the Nanoinformatics Workshop series, which resulted in development of terminology, community goals, and pilot projects that are now incorporated into a comprehensive Nanoinformatics 2020 Roadmap.
- Developed partnerships with nanotechnology industries, academia, government agencies, labor, and voluntary consensus standard committees to conduct joint research and develop guidelines on working safely with nanomaterials. This included involvement in activities of the American National Standards Institute, ASTM International, the International Standards Organization, and the International Electrotechnical Commission. This included collaboration on development of a new Web site, wiki, and other informatics and knowledge-management capabilities for sharing information, including through the NIOSH Nanoparticle Information Library and through a nanotechnology community-based initiative on minimum information for nanomaterial characterization and through development of the nanotechnology community-based Nanoinformatics 2020 Roadmap.

## Publications and Abstracts

- Castranova V, Hoover MD, Maynard A [2005]. NIOSH nanotechnology safety and health research program. In: Mark D, ed. Nanoparticles: a risk to health at work? Final Report of the First International Symposium on Occupational Health Implications of Nanomaterials, June, p. 117.
- Hoover MD [2005]. Mixed exposure issues for nanotechnology safety. In: Mark D, ed. Nanoparticles: a risk to health at work? Final Report of the First



International Symposium on Occupational Health Implications of Nanomaterials, June, p. 115.

- Hoover MD, Miller AL, Lowe NT, Stefaniak AB, Day GA, Linch KD [2005]. Information management for nanotechnology safety and health. In: Mark D, ed. Nanoparticles: a risk to health at work? Final Report of the First International Symposium on Occupational Health Implications of Nanomaterials, June, p. 110.
- Northage C, Hoover MD [2005]. Report of workshop Group F on regulatory implications. In: Mark D, ed. Nanoparticles: a risk to health at work? Final Report of the First International Symposium on Occupational Health Implications of Nanomaterials, June, pp. 145–147.
- Stefaniak AB, Day GA, Scripsick RC, Hoover MD [2005]. Comprehensive characterization strategies for ultrafine particles: lessons from beryllium health and safety studies. In: Mark D, ed. Nanoparticles: a risk to health at work? Final Report of the First International Symposium on Occupational Health Implications of Nanomaterials, June, p. 118.
- Stefaniak AB, Hoover MD, Day GA, Ekechukwu AA, Whitney G, Brink CA, Scripsick RC [2005]. Characteristics of beryllium oxide and beryllium metal powders for use as reference materials. *J ASTM Intl* 2(10):DOI 10.1520/JA113174.
- Phalen RF, Hoover MD [2006]. Aerosol dosimetry research needs. *Inhal Toxicol* 18(7–10):841–843.
- Watters RL, Hoover MD, Day GA, Stefaniak AB [2006]. Opportunities for development of reference materials for beryllium. *J ASTM Intl* 3(1):DOI 10.1520/JA113171.
- Hoover MD, Stefaniak AB, Day GA, Geraci CL [2007]. Exposure assessment considerations for nanoparticles in the workplace. In: Monteiro-Riviere NA, Tran CL, eds. *Nanotoxicology: characterization, dosing, and health effects*. New York: Informa Healthcare USA Inc., pp. 71–83.
- Miller AL, Hoover MD, Mitchell DM, Stapleton BP [2007]. The Nanoparticle Information Library (NIL): a prototype for linking and sharing emerging data. *J Occup Environ Hyg* 4(12):D131–D134.
- American Industrial Hygiene Association [2007]. *Guidance for conducting control banding analyses*. Fairfax, Virginia: American Industrial Hygiene Association. Document 9–2007.
- Hoover MD, Poster D [2008]. Environmental, health, and safety cross-cut issues for nanomanufacturing. In: Postek MT, Lyons KW, Ouimette MS, Holdridge GM, eds. *Instrumentation, Metrology, and Standards for Nanomanufacturing Workshop final report*. Washington, DC: National Science and Technology Council Interagency Working Group on Manufacturing Research and Development.

- Winchester MR, Turk GC, Butler TA, Oatts TJ, Coleman C, Nadratowski D, Sud R, Hoover MD, Stefaniak AB [2009]. Certification of beryllium mass fraction in SRM1877 beryllium oxide powder, using high-performance inductively-coupled plasma optical emission spectrometry with exact matching. *Anal Chem* 81(6):2208–2217.
- Holmes TD, Guilmette RA, Cheng YS, Parkhurst MA, Hoover MD [2009]. Aerosol sampling system for collection of capstone depleted uranium particles in a high-energy environment. *Health Phys* 96(3):221–237.
- Hoover MD [2009]. Radiation research needs for direct-reading exposure assessment methods: update from the 2008 NIOSH workshop. *Health Phys* 97(1):S97.
- Hoover MD, Baltz D, Eimer BC, Rengasamy S [2009]. Evaluation of filter media for alpha continuous air monitoring in the ultrafine particle size range. *Health Phys* 97(1):S97.
- Ekechukwu A, Hendricks W, White KT, Liabastre A, Archuleta M, Hoover MD [2009]. Validation of analytical methods and instrumentation for beryllium measurement: review and summary of available guides, procedures, and protocols. *J Occup Environ Hyg* 6:766–774.
- Hoover MD, Johnson ML [2009]. American national standard for radiation protection instrumentation test and calibration—air monitoring instruments, ANSI N323C. New York: American National Standards Institute.
- Pfefferkorn FE, Bello D, Haddad G, Park J-Y, Powell M, McCarthy J, Bunker KL, Fehrenbacher A, Jeon Y, Gruetzmacher G, Virji MA, Hoover MD [2010]. Characterization of exposures to airborne nanoscale particles during friction stir welding of aluminum. *Ann Occup Hyg* 54(5):486–503.
- Decker JA, DeBord G, Weston A, Hoover MD [2010]. Exploring the exposure: a focus on totality of exposures could mean new opportunities for industrial hygienists. *The Synergist* 21(6):32–33.
- Hoover MD, Cox M [2011]. A life-cycle approach to development and application of air sampling methods and instrumentation. In: Maiello ML, Hoover MD, eds. *Radioactive air sampling methods*. Boca Raton, Florida: CRC Press, pp. 43–52.
- Hoover MD [2011]. Behavior of radioactive aerosols and gases. In: Maiello ML, Hoover MD, eds. *Radioactive air sampling methods*. Boca Raton, Florida: CRC Press, pp.135–155.
- Hoover MD [2011]. Filtration. In: Maiello ML, Hoover MD, eds. *Radioactive air sampling methods*. Boca Raton, Florida: CRC Press, pp. 157–180.
- Hoover MD [2011]. Methods for comprehensive characterization of radioactive aerosols: a graded approach. In: Maiello ML, Hoover MD, eds. *Radioactive air sampling methods*. Boca Raton, Florida: CRC Press, pp. 341–353.



- Hoover MD, Armstrong T, Blodgett T, Fleeger AK, Logan PW, McArthur B, Middendorf PJ [2011]. Confirming our industrial hygiene decision-making framework. *The Synergist* 22(1):10.
- de la Iglesia D, Harper S, Hoover MD, Klaessig F, Lippell P, Maddux B, Morse J, Nel A, Rajan K, Reznik-Zellen R, Tuominen MT [2011]. Nanoinformatics 2020 roadmap. Available at <http://eprints.internano.org/607/>.
- Thomas DG, Klaessig F, Harper SL, Fritts M, Hoover MD, Gaheen S, Stokes TH, Reznik-Zellen R, Freund ET, Klemm JD, Paik DS, Baker NA [2011]. Informatics and standards for nanomedicine technology. *Wiley Interdisciplinary Reviews: Nanomedicine and Nanobiotechnology* 3(5):511–532.
- Schulte PA, Geraci CL, Hodson L, Zumwalde R, Castranova V, Kuempel E, Methner MM, Hoover MD, Murashov V [2011]. Nanotechnologies and nanomaterials in the occupational setting. *Ital J Occup Environ Hyg* 1(2):63–68.
- Hoover MD [2011]. Nanotechnology: risk management challenges and opportunities. In: Knief RA, Prelas MA, eds. *Risk management for tomorrow's challenges*. LaGrange Park, Illinois: American Nuclear Society, pp. 16–26.

### Invited Presentations

- Hoover MD [2004]. Mixed exposure issues for nanotechnology safety. 1st International Symposium on Nanotechnology and Occupational Health, Buxton, UK, October 11–14.
- Hoover MD, Miller AL, Lowe NT, Stefaniak AB, Day GA, Linch KD [2004]. Information management for nanotechnology safety and health. 1st International Symposium on Nanotechnology and Occupational Health, Buxton, UK, October 11–14.
- Hoover MD, Hearl FA [2005]. NORA mixed exposures research agenda. Society of Toxicology Workshop on Contemporary Concepts in Toxicology—Charting the Future: Building the Scientific Foundation for Mixtures Joint Toxicity and Risk Assessment, Atlanta, GA, February 16–17.
- Hoover MD [2005]. An introduction to nanotechnology and the possible hazards. Institute of Occupational and Environmental Health Lecture, West Virginia University, March 1.
- Hoover MD [2005]. Lung dosimetry of boundary fire smoke samples. Wild-fire Symposium, Morgantown, West Virginia, March 31.
- Hoover MD [2005]. NIOSH nanotechnology informatics overview. NIOSH—Altair Nanotechnologies, Inc. Information Exchange Meeting, Reno, NV, April 19.
- Hoover MD [2005]. Informatics for nanotechnology safety and health. Round table on the role of the occupational safety and health professional in the emerging nanotechnology industry. American Industrial Hygiene Conference and Exposition, Anaheim, California, May 24.

- Hoover MD [2005]. Nanotechnology: addressing potential health impact. Council of State and Territorial Epidemiologists, Albuquerque, New Mexico, June 6.
- Hoover MD [2005]. Planning for the next decade of NORA: opportunities to translate research into practice through the National Occupational Research Agenda. Annual Meeting of the Health Physics Society, Spokane, Washington, July 13.
- Hoover MD [2005]. Nanotechnology: understanding and addressing potential health impacts. National Association of Scientific Materials Managers, Reno, Nevada, July 25.
- Hoover MD [2005]. Nanoparticles in the workplace. NIOSH NanoAerosols 2005 Workshop, Oglebay, Wheeling, West Virginia, August 24.
- Hoover MD, Murashov V [2005]. National and international standards activities related to nanotechnologies. NIOSH NanoAerosols 2005 Workshop, Oglebay, Wheeling, West Virginia, August 25.
- Hoover MD, Murashov V [2005]. Overview of national and international standards activities related to nanotechnologies and draft ideas for discussion. U.S. Technical Advisory Group Meeting for ISO TC 229 Nanotechnologies, National Institute for Standards and Technology, Gaithersburg, Maryland, September 8.
- Hoover MD [2005]. Nanotechnology: understanding and addressing potential health impacts. Southern California Environmental Safety, Hygiene, and Health Joint Technical Symposium, Long Beach, California, October 27.
- Miller AL, Hoover MD [2006]. Building a nanoparticle information library. National Occupational Research Agenda Symposium, Washington, DC, April 18–20.
- Eshelman JC, Hoover MD, Petsonk EL, Antao VC, Trout DB, Schulte PA [2006]. Occupational medicine issues for nanotechnology. American Occupational Health Conference, Los Angeles, California, May 10.
- Hoover MD [2006]. Exposure assessment for nanotechnology. American Industrial Hygiene Conference, Chicago, Illinois, May 13–18.
- Hoover MD [2006]. Characterization of nanoparticles in the workplace. Ask the Expert session on the NIOSH Nanotechnology Research Program, American Industrial Hygiene Conference, Chicago, Illinois, May 13–18.
- Schulte P, Geraci C, Zumwalde R, Hoover M, Castranova V, Murashov V, Howard J [2006]. Occupational safety and health issues in nanotechnology. 28th International Congress on Occupational Health, Milan, Italy, June 8–16.
- Hoover MD [2006]. NIOSH approaches to safe nanotechnology. NIST Safety Day Symposium, National Institute for Standards and Technology, Gaithersburg, Maryland, June 15.





- Hoover MD [2007]. NIOSH research on applications, safety hazards, and environmental issues for nanotechnology. CSHEMA-PRIZIM Regional Environmental Health and Safety Seminar, University of Central Florida, Orlando, Florida, April 17.
- Hoover MD [2007]. NIOSH experience in assessing practical measurement and control practices for nanoparticles. Midwest Nanotechnology Safety Workshop, Madison, Wisconsin, May 21.
- Hoover MD [2007]. Case studies in assessing practical measurement and control practices for nanoparticles. American Industrial Hygiene Association Aerosol Technology Committee Symposium On Nanotechnology: Wonders and Worries, Philadelphia, Pennsylvania, June 2.
- Hoover MD [2007]. Nanotechnology health and safety issues. U.S. Department of Energy Industrial Hygiene and Occupational Safety Special Interest Group, Philadelphia, Pennsylvania, June 8.
- Hoover MD [2007]. Overview of NIOSH research on environmental health and safety issues for nanotechnology session on health and safety issues associated with nanomaterials. Air and Waste Management Association Annual Meeting, Pittsburgh, Pennsylvania, June 27.
- Hoover MD [2007]. Reference material updates and insights from the NIOSH nanotechnology and exposure assessment research programs. NIOSH-NIST Information Exchange Meeting, National Institute of Standards and Technology, Gaithersburg, Maryland, June 14.
- Hoover MD [2007]. Nanoparticle Information Library. National Nanomanufacturing Network Workshop on Nanoinformatics Strategies, Arlington, Virginia, June 12.
- Hoover MD [2007]. Environmental Health and Safety overview—exposure assessment and control for nanoparticles in the workplace: insights from the NIOSH Nanotechnology Research Program. NanoScience+Engineering SPIE Optics+Photonics Conference, San Diego, California, August 30.
- Hoover MD [2007]. Materials necessary for health and occupational exposure studies. Workshop on standards for environmental health and safety research needs for engineered nanoscale materials. National Institute of Standards and Technology, Gaithersburg, Maryland, September 12.
- Hoover MD [2008]. NanoMetrology research at NIOSH, National Institute of Standards and Technology. NIOSH Scientific Information Exchange, National Institute of Standards and Technology, Gaithersburg, Maryland, January 28.
- Hoover MD [2008]. Insights from the NIOSH Nanotechnology Research Program. Panel discussion on accelerators and nanoparticles. Health Physics Society Midyear Meeting on Radiation-Generating Devices, Oakland, California, January 29.



- Hoover MD [2008]. NIOSH nanotechnology initiative: remarks on exposure assessment and control and informatics opportunities. NIOSH Education and Research Centers Industrial Hygiene Program Directors' Meeting, Galveston, Texas, February 10.
- Hoover MD [2008]. The collection and characterization of nanomaterials for exposure assessment. American Industrial Hygiene Association—Northern California Section Technical Symposium on the Occupational Health Aspects of Nanomaterials. Menlo Park, California, May 14.
- Hoover MD [2008]. Exposure assessment data needs for emerging issues: a case study for nanotechnology risk assessment and risk management. American Industrial Hygiene Association Conference and Exposition, Minneapolis, Minnesota, May 31–June 5.
- Hoover MD [2008]. Nanoparticle issues for the health physicist: insights from the NIOSH Nanotechnology Research Program. Annual Meeting of the Health Physics Society, Pittsburgh, Pennsylvania, July 16.
- Hoover MD [2008]. Update on the NIOSH direct-reading methods initiative. Annual Meeting of the Health Physics Society, Pittsburgh, Pennsylvania, July 16.
- Hoover MD [2008]. Demonstration of the NIOSH prototype Web-based Nanoparticle Information Library. Workshop on International Collaboration for nanoEHS Informatics, National Institute of Standards and Technology, Gaithersburg, Maryland, October 10.
- Hoover MD [2008]. Nanotechnology safety issues for radioactive materials: insights from the NIOSH Nanotechnology Research Program, Regional Inspector Counterpart Seminar. U.S. Nuclear Regulatory Commission, Region 1, King of Prussia, Pennsylvania, December 10.
- Shaffer R, Hoover MD [2009]. Effectiveness of PPE and engineering controls for nanomaterials. 237th National Meeting of the American Chemical Society, Salt Lake City, Utah, March 23.
- Hoover MD [2009]. Applying principles of control banding to engineered nanoparticles. Teleweb Update on Control Banding: Fundamentals, Issues, Applications and Strategies for Implementation, American Industrial Hygiene Association, Distance Learning Program, March 26.
- Kulinowski KM, Hankin SM, Hoover MD, Jaffe M, Riediker M, Stockmeier BC [2009]. Promoting good practices for handling nanomaterials: an international wiki project. NanoImpactNet Conference for a Healthy Environment in a Future with Nanotechnology, Lausanne, Switzerland, March 26.
- Hoover MD [2009]. Nanotechnology exposure assessment, control, and informatics. Nanotechnology Health and Safety Conference, Austin, Texas, April 28.



- Hoover MD [2009]. Radiation research needs for direct-reading exposure assessment methods: update from the 2008 NIOSH workshop. 54th Annual Meeting of the Health Physics Society, Minneapolis, Minnesota, July 15.
- Hoover MD, Baltz D, Eimer BC, Rengasamy S [2009]. Evaluation of filter media for alpha continuous air monitoring in the ultrafine particle size range. 54th Annual Meeting of the Health Physics Society, Minneapolis, Minnesota, July 15.
- Gaheen S, Hoover MD [2009]. Informatics to support the health implications and applications of nanotechnology. CDC Public Health Informatics Conference, Atlanta, Georgia, August 30.
- Hoover MD [2009]. Nanotechnology: risk management challenges and opportunities. American Nuclear Society Embedded Topical Meeting on Risk Management for Tomorrow's Challenges, Washington, DC, November 16.
- Hoover MD [2010]. A graded approach to safe nanotechnology in the workplace. Teleweb Introduction to Nanotechnology and Occupational Health, American Industrial Hygiene Association, Distance Learning Program, March 23.
- Hoover MD [2010]. Public health applications of nanotechnology. CDC Public Health Grand Rounds Session on Preventing Adverse Health Effects from Nanotechnology, Atlanta, Georgia, April 15.
- Hoover MD [2010]. Nanoinformatics. NIOSH Nanotechnology Research Center Face-to-Face Workshop, Wheeling, West Virginia, April 21.
- Hoover MD [2010]. Exploring the exposome. American Industrial Hygiene Conference and Exposition, Denver, Colorado, May 25.
- Hoover MD [2010]. Informatics in relation to nanomaterials and worker health. Workshop on Nanomaterials and Worker Health: Medical Surveillance, Exposure Registries, and Epidemiologic Research, Keystone, Colorado, July 21–23.
- Ewert D, Geraci CL, Virji MD, Hoover MD, Gilkey D, Kosnett M, Petroka G [2010]. A comprehensive occupational health program for emerging nanotechnology processes in a pharmaceutical facility. Workshop on Nanomaterials and Worker Health: Medical Surveillance, Exposure Registries, and Epidemiologic Research, Keystone, Colorado, July 21–23.
- Baker N, Cachau R, Collins B, Freund D, Fritts M, Gaheen S, Harper S, Hoover MD, Klaessig F, Klemm J, Malghan S, Paik D, Pan S, Thomas D, Stafford G [2010]. Identifying the common informatics needs of nanomedicine characterization methodology. caBIG Annual Meeting, Washington, DC, September 6–8.
- Klemm J, Baker N, Thomas D, Harper S, Hoover MD, Fritts M, Cachau R, Gaheen S, Pan S, Stafford G, Paik D, Collins B, Freund E [2010]. nano-TAB: A standard file format for data submission and exchange on nanomaterials and characterizations. caBIG Annual Meeting, Washington, DC, September 6–8.

- Hoover MD [2010]. Welcome and charge to the group. NIOSH Exploring the Exposome Workshop, Cincinnati, Ohio, September 22–23.
- Hoover MD [2010]. Nanoparticle information library. Nanoinformatics 2010, Arlington, Virginia, November 3–5.
- Baker N, Cachau R, Collins B, Freund D, Fritts M, Gaheen S, Harper S, Hoover MD, Klaessig F, Klemm J, Malghan S, Paik D, Pan S, Thomas D, Stafford G [2010]. Identifying the common informatics needs of nanomedicine characterization methodology. Nanoinformatics 2010, Arlington, Virginia, November 3–5.
- Klemm J, Baker N, Thomas D, Harper S, Hoover MD, Fritts M, Cachau R, Gaheen S, Pan S, Stafford G, Paik D, Collins B, Freund E [2010]. nano-TAB: A standard file format for data submission and exchange on nanomaterials and characterizations. Nanoinformatics 2010, Arlington, Virginia, November 3–5.
- Hoover MD [2010]. Safe nanotechnology in the workplace. Atlanta Health Physics Society Chapter Meeting, Atlanta, Georgia, November 9.
- Hoover MD [2010]. Informatics resources and opportunities in relation to nanomaterials and worker health. Grand Rounds Lecture, Institute of Occupational and Environmental Health, West Virginia University, Morgantown, West Virginia, November 12.
- Hoover MD [2011]. Filtration and flow control fundamentals for sampling airborne nanoparticles. Professional Enrichment Program—PEP 3B, Health Physics Society Mid-Year Meeting, Charleston, South Carolina, February 6.
- Hoover MD [2011]. Some key elements for nanomaterial exposure assessment and management to advance sustainable manufacturing. EH&S Panel II Discussion, National Institute of Standards and Technology Workshop on Enabling the Carbon Nanomaterials Revolution, Gaithersburg, Maryland, March 1.
- Hoover MD [2011]. NIOSH exposure assessment strategy. AIHA–Pittsburgh Local Section Workshop on Putting Safe Nanotechnology into Practice, Nevillewood, Pennsylvania, April 6.
- Hoover MD [2011]. Emergency preparedness and response to nanoparticle incidents. AIHA–Pittsburgh Local Section Workshop on Putting Safe Nanotechnology into Practice, Nevillewood, Pennsylvania, April 6.
- Hoover MD, Stefaniak AB [2011]. Chronic beryllium disease and current research on solubility of exposure materials. Beryllium Health and Safety Committee Meeting, Edgewood, Maryland, April 7.
- Hoover MD [2011]. Case studies for anticipating, recognizing, evaluating, controlling, and confirming safe nanotechnology. Professional Development Course 503 on Applied Concepts of Nanotechnology for the EHS Professional, American Industrial Hygiene Conference and Exposition, Portland, Oregon, May 15.



- Hoover MD [2011]. Confirming the critical issues for advancing the exposure sciences. Special Session on The Exposome: The Future of Exposure Science? American Industrial Hygiene Conference and Exposition, Portland, Oregon, May 17.
- Hoover MD [2011]. ANSI/HPS N13.8 update: an opportunity to advance radioactive air sampling for radiation protection in uranium mines. 56th Annual Meeting of the Health Physics Society, West Palm Beach, Florida, June 28.
- Hoover MD [2011]. Nanoparticle characterization and control fundamentals: a graded approach. Professional Enrichment Program Course W3, 56th Annual Meeting of the Health Physics Society, West Palm Beach, Florida, June 29.
- Day LM, Walker LS, Hoover MD [2011]. Panel discussion on emerging radiation-related health and safety issues for nanotechnology. 56th Annual Meeting of the Health Physics Society, West Palm Beach, Florida, June 30.
- Hoover MD [2011]. Nanoinformatics tools. Continuing Education Course C2, 5th International Symposium on Nanotechnology, Occupational and Environmental Health, Boston, Massachusetts, August 9.
- Hoover MD [2011]. Radioactive nanoparticles: working at the frontier of interdisciplinary science. Los Alamos National Laboratory, Los Alamos, NM, September 20.
- Hoover MD [2011]. Case study: emergency preparedness and response for nanoparticle incidents. Putting Safe Nanotechnology into Practice, TVS-AIHA Local Section Workshop, Knoxville, Tennessee, October 19.
- Hoover MD [2011]. NIOSH exposure assessment strategies: a work in progress. Putting Safe Nanotechnology into Practice, TVS-AIHA Local Section Workshop, Knoxville, Tennessee, October 19.
- Hoover MD, Stefaniak AB [2011]. Physicochemical characterization of beryllium. Beryllium Summit 2011: 4th International Conference on Beryllium Disease, Cleveland, Ohio, October 21.
- Hoover MD [2011]. Lung deposition model for beryllium. Beryllium Summit 2011: 4th International Conference on Beryllium Disease, Cleveland, Ohio, October 21.
- Hoover MD [2011]. Confirming approaches to nanosafety and characterization through field and toxicity studies. 3rd Annual Conference of the American Society for Nanomedicine, Gaithersburg, Maryland, November 9.
- Hoover MD [2011]. Anticipating, recognizing, evaluating, controlling, and confirming an effective nanoinformatics roadmap. 3rd Annual Conference of the American Society for Nanomedicine, Gaithersburg, Maryland, November 10.

## Project 68: Global Harmonization of Exposure Measurement and Exposure Mitigation Approaches for Nanomaterials

**Principal Investigator:** Vladimir Murashov, PhD

**Project Duration:** FY 2006–2011

**Critical Topic Areas:** International activities in safety and health, including exposure assessment, risk assessment, recommendations and guidance, and communication and information

### Accomplishments and Research Findings

- Coordinated the international and interagency activities of the NIOSH Nanotechnology Research Program.
- Chaired the Organization for Economic Cooperation and Development Working Party for Manufactured Nanomaterials Steering Group 8, Exposure Measurement and Exposure Mitigation.
- Organized two OECD workshops on nanomaterial exposure measurement and mitigation.
- Chaired the development of WHO Guidelines on Protecting Workers from Potential Risks of Nanomaterials and developed WHO topic page on nanomaterial safety.
- Co-led a WHO project on best practices for safe handling of nanomaterials.
- Developed content for UNITAR training material on occupational safety and health for nanotechnology for low and medium income countries and made presentations at UNITAR workshops.
- Developed occupational safety and health content for United Nations Environmental Program's report on nanotechnology safety and health.
- Led the development and publication of ISO TR/12885:2008 Health and Safety Practices in Occupational Settings Relevant to Nanotechnologies.
- Chaired ANSI U.S. Technical Advisory Group to ISO TC229 Working Group 3 on Nanotechnology Safety and Health.
- Provided technical expertise for several ISO TC229 standards projects.
- Represented NIOSH on several national and international working groups and committees on nanotechnology safety and health.



- Represented NIOSH on the National Nanotechnology Initiative interagency subcommittee and its working groups.
- Presented overviews of the NIOSH Nanotechnology Research Program to outside stakeholders.
- Edited a Special Issue on Exposure Assessment for Nanomaterials in the International Journal of Occupational and Environmental Health.
- Led the development of WHO Guidelines on Protecting Workers from Potential Risks of Manufactured Nanomaterials and of WHO topic page on nanomaterial safety.

### Publications and Abstracts

- Murashov VV, Howard J [2007]. Biosafety, occupational health, and nanotechnology. *Appl Biosafety* 12(3):158–167.
- Murashov V, Howard J [2008]. The U.S. must help set international standards for nanotechnology. *Nature Nanotechnol* 3:635–636.
- Schulte PA, Geraci CL, Zumwalde R, Hoover M, Castranova V, Kuempel E, Murashov V, Vainio H, Savolainen K [2008]. Sharpening the focus on occupational safety and health of nanotechnology in the workplace. *Scand J Work Environ Health* 34(6):471–478.
- ISO [2008]. Health and safety practices in occupational settings relevant to nanotechnologies. Geneva, Switzerland: International Organization for Standardization, ISO/TR-12885.
- NIOSH [2008]. Nanotechnology: should carbon nanotubes be handled in the workplace like asbestos? Cincinnati, OH: U.S. Department of Health and Human Services, Public Health Service, Centers for Disease Control and Prevention, National Institute for Occupational Safety and Health, NIOSH Science Blog, May.
- NIOSH [2009]. Nanotechnology: Human and Environmental Exposure Assessment for Nanomaterials Workshop. Cincinnati, OH: U.S. Department of Health and Human Services, Public Health Service, Centers for Disease Control and Prevention, National Institute for Occupational Safety and Health, NIOSH Science Blog, March.
- Howard J, Murashov V [2009]. National nanotechnology partnership to protect workers. *J Nanopart Res* 11(7):1673–1683.
- Murashov V, Engel S, Savolainen K, Fullam B, Lee M, Kearns P [2009]. Occupational safety and health in nanotechnology and Organisation for Economic Co-operation and Development. *J Nanopart Res* 11(7):1587–1591.
- Murashov V, Howard J [2009]. Essential features of proactive risk management. *Nature Nanotech* 4(8):467–470.



- Murashov V, Howard J [2009]. International standards for risk management in nanotechnology. *Nature Nanotech* 4:205–206.
- Murashov V [2009]. Occupational exposure to nanomedical applications. *Wiley Interdisciplinary Reviews: Nanomedicine and Nanobiotechnology* 1(2):203–213.
- OECD [2009]. Comparison of guidance on selection of skin protective equipment and respirators for use in the workplace: manufactured nanomaterials. Organization for Economic Cooperation and Development, ENV/JM/MONO(2009)17.
- OECD [2009]. Emission assessment for identification of sources and release of airborne manufactured nanomaterials in the workplace: compilation of existing guidance. Organization for Economic Cooperation and Development, ENV/JM/MONO(2009)16.
- OECD [2009]. Preliminary analysis of exposure measurement and exposure mitigation in occupational settings: manufactured nanomaterials. Organization for Economic Cooperation and Development, ENV/JM/MONO(2009)6.
- Schulte PA, Geraci CL, Hodson L, Zumwalde R, Castranova V, Kuempel E, Methner MM, Hoover M, Murashov V [2010]. Nanotechnologies and nanomaterials in the occupational setting. *Ital J Occup Environ Hyg* 1(2):63–68.
- Murashov [2010]. Human and environmental exposure assessment for nanomaterials: an introduction to this issue. *Int J Occup Environ Health* 16(4):363–364.
- Schulte P, Murashov V, Kuempel E, Zumwalde R, Geraci C [2010]. Occupational exposure limits for nanomaterials: state of the art. *J Nanopart Res* 12(6):1971–1987.
- Murashov V, Schulte P, Geraci C, Howard J [2011]. Regulatory approaches to worker protection in nanotechnology industry in the USA and European Union. *Ind Health* 49(3):280–296.
- NIOSH [2011]. Titanium dioxide: a changing paradigm in occupational risk management. Cincinnati, OH: U.S. Department of Health and Human Services, Public Health Service, Centers for Disease Control and Prevention, National Institute for Occupational Safety and Health, NIOSH Science Blog, May.
- NIOSH [2011]. Pleuropulmonary disease in a polyacrylate facility: a reminder of the need to protect workers from hazardous dust. Cincinnati, OH: U.S. Department of Health and Human Services, Public Health Service, Centers for Disease Control and Prevention, National Institute for Occupational Safety and Health, NIOSH Science Blog, July.
- Murashov V, Howard J, eds [2011]. *Nanotechnology standards*. New York, NY: Springer Science+Business Media, ISBN: 978-1-4419-7852-3.
- Murashov V, Howard J [2011]. Introduction. In: Murashov V, Howard J, eds. *Nanotechnology standards*. New York, NY: Springer, pp. 1–20.





- Murashov V, Howard J [2011]. Health and safety standards. In: Murashov V, Howard J, eds. Nanotechnology standards. New York, NY: Springer, pp. 209–238.
- SAICM [2011]. Report on nanotechnologies and manufactured nanomaterials [SAICM/OEWG.1/INF/8]. Strategic approach to international chemicals management. Geneva, Switzerland: United Nations.

### Government Publications

- NSTC [2007]. The national nanotechnology initiative strategic plan. By Nanoscale Science, Engineering, and Technology Subcommittee, Committee on Technology. Arlington, VA: National Science and Technology Council.
- NSTC [2007]. Prioritization of environmental, health, and safety research needs for engineered nanoscale materials. An interim document for public comment. By Nanoscale Science, Engineering, and Technology Subcommittee, Committee on Technology. Arlington, VA: National Science and Technology Council.
- NSTC [2008]. Strategy for nanotechnology-related environmental health and safety research. By Nanoscale Science, Engineering, and Technology Subcommittee, Committee on Technology. Arlington, VA: National Science and Technology Council.
- NSTC [2010]. Draft National Nanotechnology Initiative 2011: Environmental, Health, and Safety Strategy. Available at <http://strategy.nano.gov/wp/wp-content/uploads/2010/12/DraftEHSstrategy-17Dec2010-to-post.pdf>.
- NSTC [2010]. Human and environmental exposure assessment. Available at <http://www.nano.gov/html/society/ExposureAssessmentWorkshopReportforWeb.pdf>.
- EPA [2010]. A set of scientific issues being considered by the environmental protection agency regarding: evaluation of the hazard and exposure associated with nanosilver and other nanometal pesticide products. By Barber D, Hu Z, Filon FL, Linkov I, Murashov V, Philbert M, Roberts J, Sayes C, Westerhoff P, Yu IJ. EPA SAP Minutes No. 2010-01, February 2010.
- NSTC [2011]. National Nanotechnology Initiative 2011: Environmental, Health, and Safety (EHS) Research Strategy. Nanoscale Science, Engineering, and Technology Subcommittee, Committee on Technology, National Science and Technology Council, October 2011. Available at <http://www.nano.gov/node/681>.

### Invited Presentations

- Murashov V [2007]. Nanotechnology: occupational safety and health. State-of-the-Art Conference/International Conference on Health Care Worker Health, Vancouver, British Columbia, Canada, October 26.
- Murashov V [2007]. Nanotechnology: occupational safety and health. Nano Applications Summit—CleanTech Day, Cleveland, Ohio, October 24.

- Murashov V [2007]. Nanotechnology: occupational health and safety. Mid-Atlantic Regional Conference on Occupational Medicine, Baltimore, Maryland, October 13.
- Murashov V [2007]. Nanotechnology health and safety concerns. American Society of Safety Engineers, Region VI PDC, Myrtle Beach, South Carolina, September 20.
- Murashov V [2007]. Considerations for selecting standard materials for occupational safety and health. Interagency Workshop on Standards for Environmental Health and Safety Research Needs for Engineered Nanoscale Materials. Gaithersburg, Maryland, September 12.
- Murashov V [2007]. NIOSH nanotechnology research program. Interagency Workshop on the Environmental Implications of Nanotechnology, Washington, DC, September 5.
- Murashov V [2007]. NIOSH nanotechnology research program. Annual Environmental Health and Exposure Assessment Workshop, Washington, DC, August 17.
- Murashov V [2007]. Social studies at NIOSH. The Joint Wharton-CHF Symposium on Social Studies of Nanotechnology, Philadelphia, Pennsylvania, June 8.
- Murashov V [2007]. Nanotechnology: occupational health and safety. Conference on Risk Assessment for Nanomaterials, Cambridge, Massachusetts, May 29.
- Murashov V [2007]. NIOSH nanotechnology research program. Conference on Nanotech 2007, Santa Clara, California, May 21.
- Murashov V [2007]. Nanotechnology health and safety concerns. Meeting of National Aeronautics and Space Administration Code 500 Safety Awareness Campaign, Greenbelt, Maryland, April 18.
- Murashov V [2007]. NIOSH nanotechnology research program. Navy Occupational Health and Safety Preventive Medicine Conference, Hampton, Virginia, March 20.
- Murashov V [2007]. Safe handling of nanotechnology. OSHA/NIOSH Journal Club, Washington, DC, March 29.
- Murashov V [2007]. Nanotechnology health and safety concerns—NIOSH nanotechnology research program. Intertech-PIRA Workshop, Washington, DC, February 8.
- Murashov V [2008]. Nanotechnology and risk. Metro Washington College of Occupational and Environmental Medicine Meeting, Bethesda, Maryland, December 3.



- Murashov V [2008]. NIOSH nanotechnology research program. Meeting of National Center for Nanoscience and Technology of China, Beijing, China, November 14.
- Murashov V [2008]. NIOSH nanotechnology research program. Meeting of Chinese National Institute of Occupational Health and Poison Control, Beijing, China, November 13.
- Murashov V [2008]. NIOSH nanotechnology research program. Conference on Sustainable Nanotechnology Innovations, Products, and Toxicology, Fayetteville, Arkansas, August 14.
- Murashov V [2008]. NIOSH nanotechnology research program. Nanoscale Science, Engineering and Technology Subcommittee Meeting, Arlington, Virginia, July 15.
- Murashov V [2008]. Nanotechnology: occupational safety and health. Workshop on Biological Interaction of Engineered Nanomaterials: Environmental, Safety, and Health Issues of Military Concern, Wright Patterson Air Force Base, Dayton, Ohio, June 25.
- Murashov V [2008]. Nano health, safety and environment and worker protection. Second Jisso International Forum, Atlanta, Georgia, May 22.
- Murashov V [2008]. Nanotechnology: exposure assessment. International Symposium on Risk Assessment of Manufactured Nanomaterials, Tokyo, Japan, April 23.
- Murashov V [2008]. Nanotechnology and risk. 2008 Controlled Environment Testing Association Conference, San Antonio, Texas, April 14.
- Murashov V [2008]. Nanotechnology and risk. Joint BIONET/BSAF Symposium on Current Topics in Biosafety, La Jolla, California, March 7.
- Murashov V [2008]. Exposure assessment and control practices for nanoparticles. University of California, San Diego, Forum, San Diego, California, March 6.
- Murashov V [2008]. International Organization for Standardization TC146/SC2. International Organization for Standardization Workshop on Documentary Standards for Measurement and Characterization in Nanotechnologies, Gaithersburg, Maryland, February 26.
- Murashov V [2008]. OECD WPMN SG8 Cooperation on exposure measurement and exposure mitigation. International Organization for Standardization Workshop on Documentary Standards for Measurement and Characterization in Nanotechnologies, Gaithersburg, Maryland, February 26.
- Murashov V [2008]. Nanotechnology and risk. California State University in Northridge, Environmental and Occupational Health Nanotech Symposium, Northridge, California, February 20.

- Murashov V [2008]. NIOSH Nanotechnology Research Program. State-of-the-Art Conference/International Conference on Health Care Worker Health, Vancouver, British Columbia, Canada, October 27.
- Murashov V [2009]. Exposure mitigation in the workplace. UNITAR Workshop on Nanotechnology Safety and Health, Lodz, Poland, December 11.
- Murashov V [2009]. Nanomaterial exposure assessment. Institute for Safety and Health at Work, Lausanne, Switzerland, October 2.
- Murashov V [2009]. NIOSH nanotechnology program. UK House of Lords Science and Technology Committee visit, Washington, June 23.
- Murashov V [2009]. NIOSH nanotechnology program. Nanotechnology Health and Safety Forum, Seattle, Washington, June 8.
- Murashov V [2009]. Nanotechnology: occupational safety and health. Fifth International Conference on Collaboration in Nanotechnology, Los Angeles, California, May 18.
- Murashov V [2009]. Nanotechnology risk and potential for health surveillance. DOE Spring EFCOG Occupational Medicine Subgroup Meeting, Argonne, Illinois, April 20.
- Murashov V [2009]. Carbon nanotube data call-in from NIOSH. Nanomaterial Data Call-Ins and Their Regulatory and Enforcement Implications, Washington, DC, April 15.
- Murashov V [2009]. Overview of nanotechnology environmental and health implications workgroup. NNI Human and Environmental Exposure Assessment Workshop, Bethesda, Maryland, February 24–25.
- Murashov V [2010]. NIOSH current intelligence bulletin on carbon nanotubes and nanofibers. ISO TC229 Meeting, Kuala Lumpur, Malaysia, December 6.
- Murashov V [2010]. Advances and interventions related to occupational health risks of nanomaterials. 1st International Congress on Environmental Health, Guadalajara, Mexico, October 20.
- Murashov V [2010]. Exposure mitigation in the workplace. UNITAR Workshop on Nanotechnology Safety and Health, Kingston, Jamaica, March 12.
- Murashov V [2010]. Regulatory approaches to nanotechnology OSH. 4th JNIOH International Workshop for Occupational Safety and Health Promotion, Tokyo, Japan, January 28.
- Murashov V [2011]. ISO TC229/WG3: strategy considerations. ISO TC229 Meeting, Johannesburg, South Africa, November 14.
- Murashov V [2011]. WHO guidelines on protecting workers from potential risks of manufactured nanomaterials. ISO TC229 Meeting, Johannesburg, South Africa, November 14.



- Murashov V [2011]. Nanotechnology Occupational Safety and Health: global standards development. 5th International Conference on Nanotechnology Occupational and Environmental Health, Boston, USA, August 10–12.
- Murashov V [2011]. Nanotechnology occupational safety and health: global standards development. INRS 2011, Nancy, France, April 7.

## Project 69: New Sensor Technology Development for Filter Respirator Cartridge End-of-Service-Life Indicators (ESLI)

**Principle Investigator:** Jay Snyder, MS

**Project Duration:** FY 2002–2010

**Critical Topic Area:** Applications

### Accomplishments and Research Findings

- Developed sensors and integrated them into APR cartridges for evaluation.
- Developed sensors and integrated them into PAPR cartridges for evaluation.
- Developed new nanomaterials for chemical sensing.
- Research findings are now being used in the update of NIOSH PAPR respirator standards.
- Obtained a patent: Sailor, Ruminski, King, Snyder. Optical fiber-mounted porous photonic crystals and sensors. U.S. Patent #7,889,954, issued Feb. 15, 2011. Patent assigned to the Regent of the University of California.

### Publications and Abstracts

- McCullough RD, Sauvé G, Li B, Jeffries ELM, Santhanam S, Schultz L, Zhang R, Iovu MC, Cooper J, Sreedharan P, Revelli JC, Kusner AG, Kowalewski T, Snyder JL, Weiss LE, Lambeth DN, Fedder GK [2005]. Regioregular polythiophene nanowires and sensors. In: Proceedings of SPIE, Vol. 5940. Organic Field-Effect Transistors IV. Bellingham, WA: International Society for Optical Engineering, pp. 28–34.
- Li B, Santhanam S, Schultz L, Jeffries ELM, Iovu MC, Sauvé G, Cooper J, Zhang R, Revelli JC, Kusne AG, Snyder J, Kowalewski T, Weiss LE, McCullough RD, Fedder GK, Lambeth DN [2007]. Inkjet printed chemical sensor array based on polythiophene conductive polymers. *Sensors Actuators B* 123(2):651–660.
- Fedder GK, Bedair SS, Garg N, Greenblatt J, Jin R, Lambeth DN, Lazarus N, Santhanam S, Schultz L, Snyder JL, Weiss LE, Wu J [2008]. Jetted nanoparticle chemical sensor circuits for respirator end-of-service-life detection. In: Proceedings of the 12th International Meeting on Chemical Sensors 2008 (IMCS 08), Columbus, Ohio, July 13–16.
- Qian H, Jin R [2009]. Controlling nanoparticles with atomic precision: the case of Au<sub>144</sub>(SCH<sub>2</sub>CH<sub>2</sub>Ph)<sub>60</sub>. *Nano Lett* 9:4083–4087.



- Bedair SS, Fedder GK [2009]. Picogram material dosing of microstructures. *J Appl Phys* 106(10):4913–4917.
- Lazarus N, Bedair SS, Lo C-C, Fedder GK [2010]. CMOS-MEMS capacitive humidity sensor. *J Microelectromech Syst* 19(1):183–191.
- Garg N, Mohanty A, Lazarus N, Schultz L, Rozzi TR, Santhanam S, Weiss L, Snyder JL, Fedder GK, Jin R [2010]. Robust gold nanoparticles stabilized by trithiol for application in chemiresistive sensors. *Nanotechnology* 21(40):405–501.
- King BH, Ruminski AM, Snyder JL, Sailor MJ [2007]. Optical-fiber-mounted porous silicon photonic crystals for sensing organic vapor breakthrough in activated carbon. *Adv Mater* 19:4530–4534.
- Ruminski AM, King BH, Salonen J, Snyder JL, Sailor MJ [2010]. Porous silicon-based optical microsensors for volatile organic analytes: effect of surface chemistry on stability and specificity. *Adv Funct Mater* 20:2874–2883.
- Sailor, Ruminski, King, Snyder. Optical fiber-mounted porous photonic crystals and sensors. U.S. Patent #7,889,954, issued Feb. 15, 2011. Patent assigned to the Regent of the University of California.

### Invited Presentations

- Snyder JL [2005]. Volatile organic compound discrimination using nanostructured polythiophene sensors. Presented at the IEEE 2005 Sensors Conference, Irvine, California, October 30–November 3.
- Snyder J [2007]. End-of-service-life sensor systems for personal protective equipment. Scientific Conference on Chemical and Biological Defense Research, Timonium, Maryland, November 13–15.
- Snyder J [2007]. End-of-service life sensors and models. Technical Support Working Group, Personal Protective Equipment Conference, Fort Lauderdale, Florida, November 27–29.
- Snyder J [2008]. Jetted nanoparticle chemical sensor circuits for respirator end-of-service-life detection. 12th International Meeting on Chemical Sensors, Columbus, Ohio, July 13–16.
- Snyder J [2008]. Chemically modified porous silicon for optical sensing of organic vapor breakthrough in activated carbon filters. Nanomaterials for Defense Conference, Arlington, Virginia, April 21–24.
- Snyder J [2008]. End-of-service life sensor development. International Isocyanate Institute (III) America Analytical Subcommittee Meeting, Boulder, Colorado, June 9.
- Snyder J [2008]. A cartridge simulator for testing end-of-service life indicators. International Society for Respiratory Protection, 14th International Conference, Dublin, Ireland, September 14–18.



- Snyder J [2010]. Application of chemistry to end-of service life determination of personal protective equipment. 240th American Chemical Society Meeting, Boston, Massachusetts, August 25.
- Snyder J [2011]. Sensor development for personal protective equipment. NPPTL III Meeting, Pittsburgh, Pennsylvania, June 9.



# NTRC Projects in the 10 Critical Areas for 2004–2011

## APPENDIX B

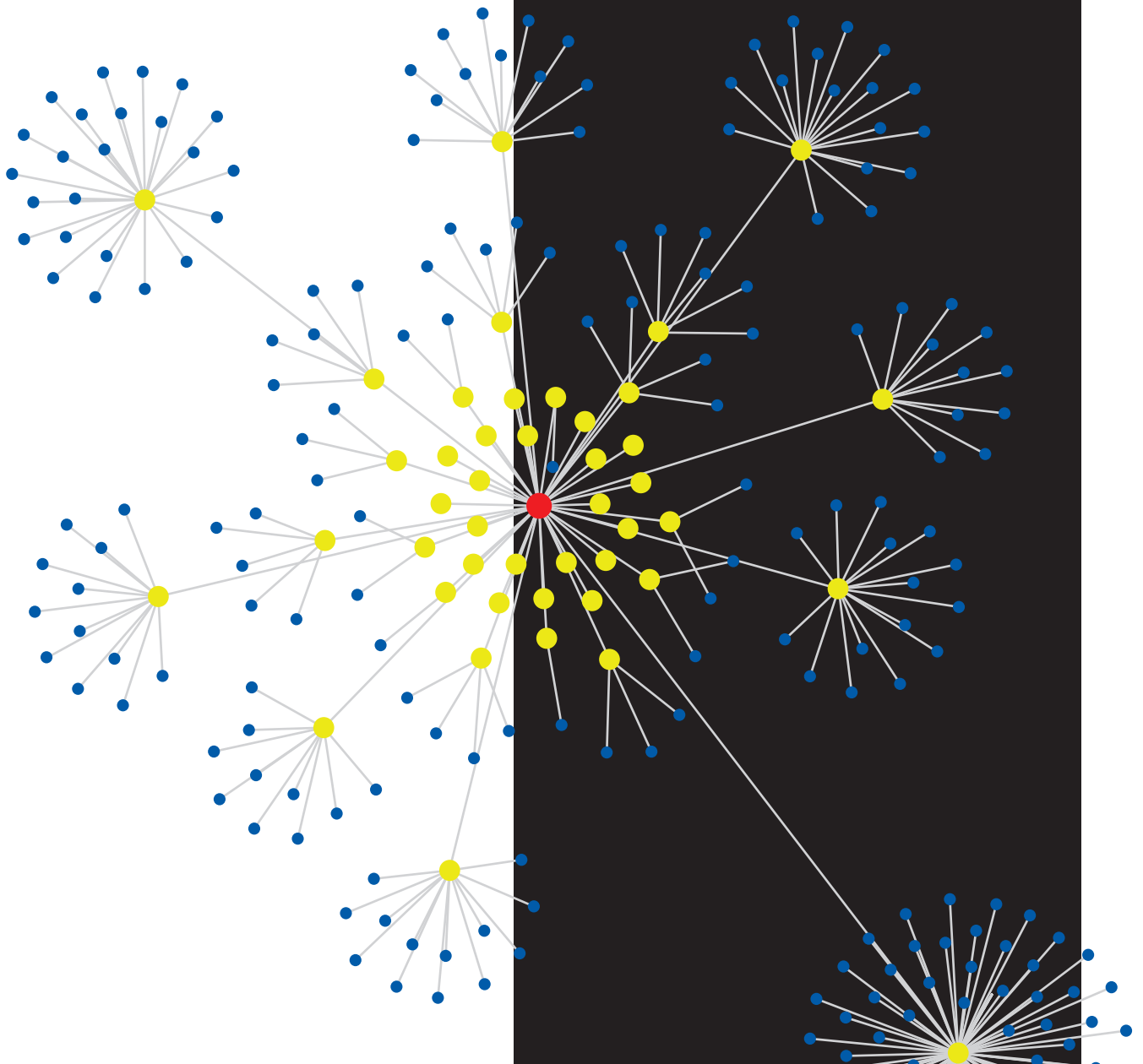



**Table B1. NTRC projects in the 10 critical topic areas for 2004-2011**

Project number	Toxicology and internal dose	Measurement methods	Exposure assessment	Epidemiology and surveillance	Risk assessment	Engineering controls and PPE*	Fire and explosion	Recommendation and guidance	Communication and information	Applications
1	X	X	X	X	X	X	X	X	X	X
2	X									
3	X									
4	X									
5	X									
6	X									
7	X									
8	X									
9	X									
10	X									
11	X									

See footnote at end of table.

(continued)

**Table B1 (Continued). NTRC projects in the 10 critical topic areas for 2004-2011**

Project number	Toxicology and internal dose	Measurement methods	Exposure assessment	Epidemiology and surveillance	Risk assessment	Engineering controls and PPE*	Fire and explosion	Recommendation and guidance	Communication and information	Applications
12	X									
13	X									
14	X									
15	X									
16	X									
17	X									
18	X									
19	X									
20	X									
21	X									
22	X									

See footnote at end of table.

(continued)



**Table B1 (Continued). NTRC projects in the 10 critical topic areas for 2004-2011**

Project number	Toxicology and internal dose	Measurement methods	Exposure assessment	Epidemiology and surveillance	Risk assessment	Engineering controls and PPE*	Fire and explosion	Recommendation and guidance	Communication and information	Applications
23	X									
24	X									
25	X									
26	X									
27	X									
28	X									
29	X									
30	X		X							
31	X									
32	X		X							
33	X									

See footnote at end of table.

(continued)

**Table B1 (Continued). NTRC projects in the 10 critical topic areas for 2004-2011**

Project number	Toxicology and internal dose	Measure-ment methods	Exposure assessment	Epidemiology and surveillance	Risk assessment	Engineering controls and PPE*	Fire and explosion	Recommendation and guidance	Communication and information	Applications
34		X								
35		X	X				X			
36		X	X							
37		X	X							
38		X	X							
39		X	X							
40		X								
41		X	X							
42		X	X							
43		X								
44		X								

See footnote at end of table.

(continued)





**Table B1 (Continued). NTRC projects in the 10 critical topic areas for 2004-2011**

Project number	Toxicology and internal dose	Measurement methods	Exposure assessment	Epidemiology and surveillance	Risk assessment	Engineering controls and PPE*	Fire and explosion	Recommendation and guidance	Communication and information	Applications
45		X								
46		X	X							
47		X	X		X					
48		X	X							
49		X								
50		X	X							
51		X	X		X	X		X		X
52			X	X						
53				X				X		
54			X	X						
55					X					

See footnote at end of table.

(continued)

**Table B1 (Continued). NTRC projects in the 10 critical topic areas for 2004-2011**

Project number	Toxicology and internal dose	Measure-ment methods	Exposure assessment	Epidemiology and surveillance	Risk assessment	Engineering controls and PPE*	Fire and explosion	Recommendation and guidance	Communication and information	Applications
56					X					
57						X		X		
58						X		X		
59						X				
60						X				
61			X			X				
62						X				
63							X			
64					X			X		
65					X			X		
66										X

See footnote at end of table.

(continued)



**Table B1 (Continued). NTRC projects in the 10 critical topic areas for 2004-2011**

Project number	Toxicology and internal dose	Measurement methods	Exposure assessment	Epidemiology and surveillance	Risk assessment	Engineering controls and PPE*	Fire and explosion	Recommendation and guidance	Communication and information	Applications
67		X	X						X	
68			X		X			X		X
69										X

\*PPE: Personal Protective Equipment

# NIOSH Extramural Research

## APPENDIX C

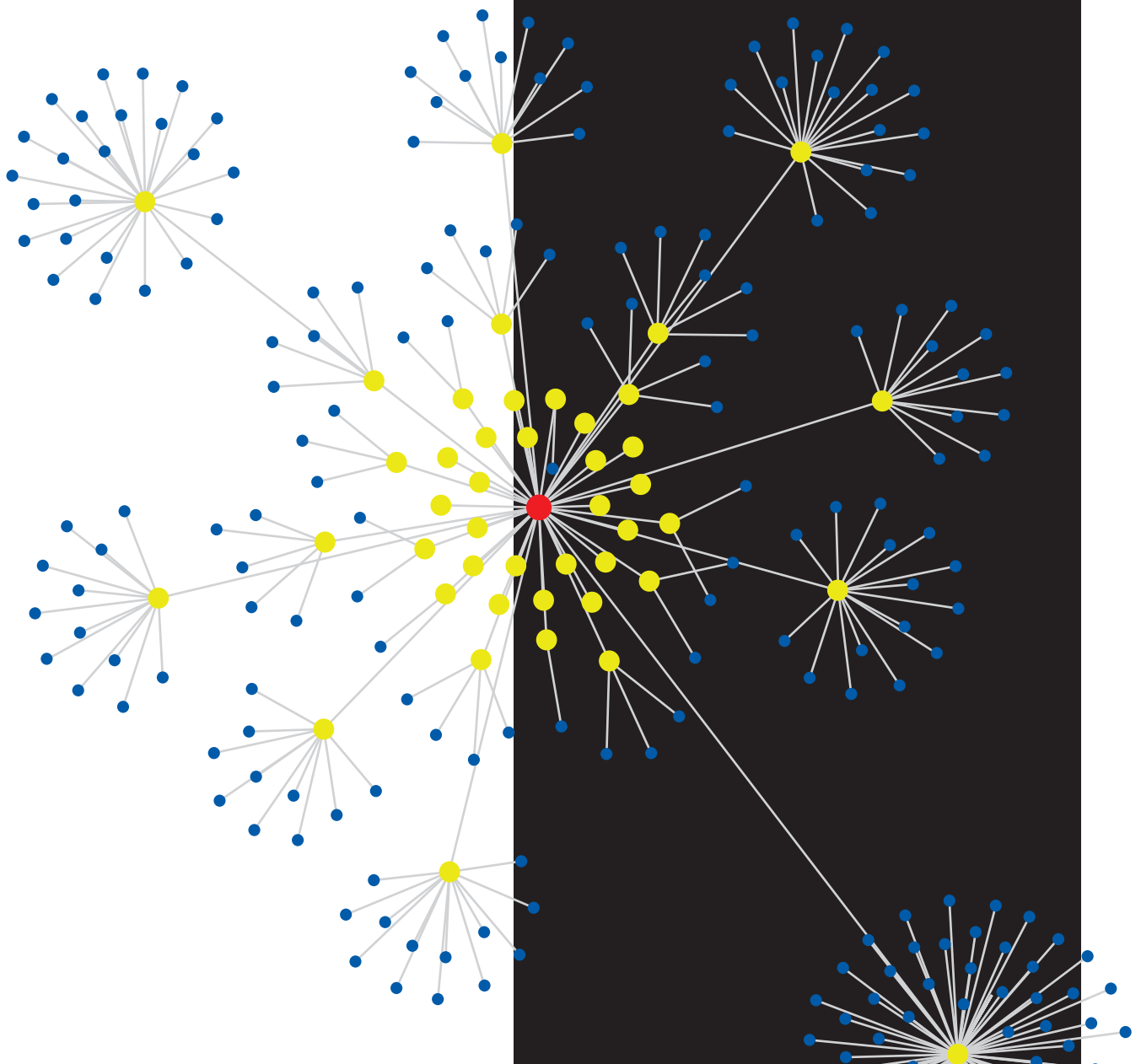



## **Nanotechnology Portfolio Summary**

### **2001-2011**

#### **Prepared by**

W. Allen Robison, Ph.D. and Viji Potula, Ph.D.

#### ***National Institute for Occupational Safety and Health***

Office of Extramural Programs

Atlanta, GA

December 31, 2011



## Background

The mission of NIOSH is to generate new knowledge in the field of occupational safety and health and to transfer that knowledge into practice for the betterment of workers. To accomplish this mission, NIOSH conducts scientific research, develops guidance and authoritative recommendations, disseminates information, and responds to requests for workplace health hazard evaluations. NIOSH provides national and world leadership to prevent work-related illness, injury, disability, and death by gathering information, conducting scientific research, and translating the knowledge gained into products and services, including scientific information products, training videos, and recommendations for improving safety and health in the workplace.

NIOSH sponsors research and training outside the Institute through the Office of Extramural Programs (OEP). The creativity and special resources available in the extramural community make these programs an important component in achieving a national goal to have safe jobs and healthy workers. The office also serves to help NIOSH address priorities from the National Occupational Research Agenda (NORA), the NIOSH Research to Practice (r2p) Program, congressional mandates, and the NIOSH Program Portfolio.

A variety of occupational safety and health-related research grants, cooperative agreements, training grants and conference grants outside the Institute are managed by OEP. The competitive process for soliciting applications, conducting peer reviews and for making awards is managed by OEP.

The extramural office works closely with public and private academic institutions, state and federal agencies, and with small private businesses. Extramural program scientists also consult with intramural scientists. Extramural applicants are encouraged to collaborate with NIOSH scientists when possible; however, extramural projects are managed separately from intramural programs to ensure fair competition, maintain research integrity, and to eliminate financial and intellectual conflicts of interest.

### What is Nanotechnology?

Nanotechnology involves engineering and manipulation of materials at the molecular level. This technology creates materials with dimensions from 1 to 100 nanometers (1 nanometer is 1 billionth of a meter). Particles created at the nanoscale have different chemical and physical properties than larger particles of the same material. Scientists and manufacturers can use nanoparticles to create new products that would be impossible with larger particles (<http://www.cdc.gov/niosh/docs/2008-112>).

### Purpose

Extramural funding of nanotechnology-related research has been undertaken to help increase the knowledge of nanotechnology and manufactured nanomaterials as they



relate to occupational safety and health. Research areas supported by NIOSH/OEP include: assessment methods for nanoparticles in the workplace, toxicology of manufactured nanomaterials, and use of nanotechnology for improved workplace monitoring. Extramural nanotechnology research adds to the overall development of new information and complements efforts undertaken within the Institute.

## Overall NIOSH Extramural Nanotechnology Research Program

From 2001–2011, NIOSH/OEP has committed \$12 million (M) to extramural nanotechnology research. Ongoing projects currently funded through FY-2014 account for another \$3.6M (Figure 1), which brings the total to about \$15.6M. This has been accomplished by the use of non-earmarked research funds, NIOSH program announcements, joint requests for applications with other federal agencies, and Small Business Innovation Research (SBIR) funds. The office has not received specific funds for nanotechnology research.

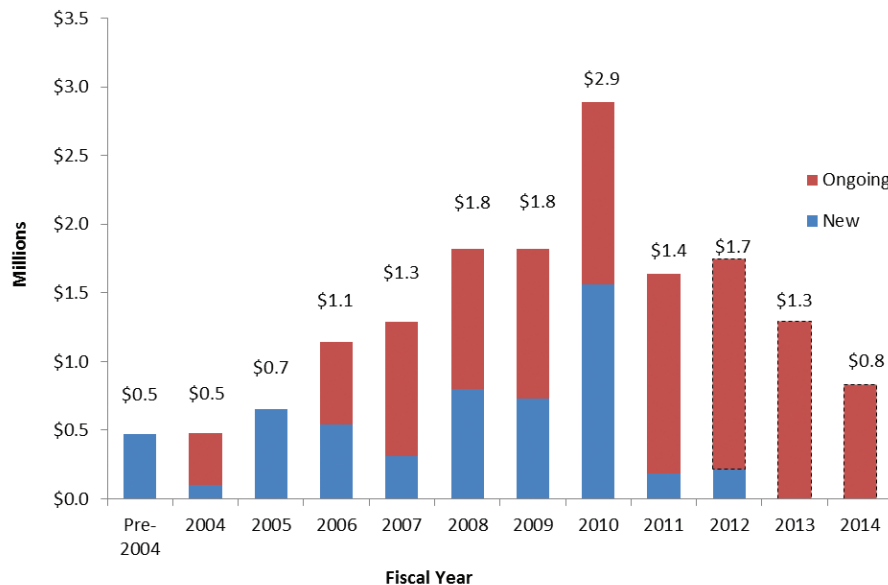

**Figure 1.** NIOSH/OEP funding for nanotechnology research, 2001–2011.

## Funding Partnerships

OEP has partnered in two joint Requests for Applications (RFAs) for Nanotechnology Research Grants Investigating Environmental and Human Health Issues. The US Environmental Protection Agency’s National Center for Environmental Research (NCER) and the National Science Foundation (NSF) participated in FY-05. The National Institute of Environmental Health Sciences (NIEHS) joined in FY-06. Funding



was available to support Research (R01) grants for three years and Exploratory (R21) grants for two years.

## Funding Mechanisms

Figure 2 summarizes the five types of funding mechanisms used by NIOSH for extramural nanotechnology research. SBIR (R43/44) and major research projects (R01) represent the major categories.

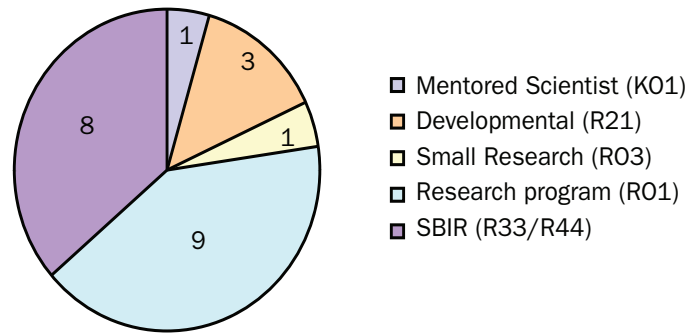

**Figure 2.** NIOSH extramural projects (2001–2011) in nanotechnology, by grant mechanism.

## Extramural Research Projects and NIOSH Nanotechnology Goals

Major NIOSH goals for nanotechnology research are:

1. Determine if nanoparticles and nanomaterials pose risks for work-related injuries and illnesses.
2. Conduct research to prevent work-related injuries and illnesses by applying nanotechnology products.
3. Promote healthy workplaces through interventions, recommendations, and capacity building.
4. Enhance global workplace safety and health through national and international collaborations on nanotechnology research and guidance.

For more information on NIOSH nanotechnology goals, please visit the following website: [http://www.cdc.gov/niosh/topics/nanotech/strat\\_planINTRO.html](http://www.cdc.gov/niosh/topics/nanotech/strat_planINTRO.html).

Extramural NIOSH funding for nanotechnology research has primarily been related to goals 1–3 (Figure 3). NIOSH/OEP continues to pursue partnerships in sponsoring funding opportunities that involve global collaborations between scientists in the US and other countries.

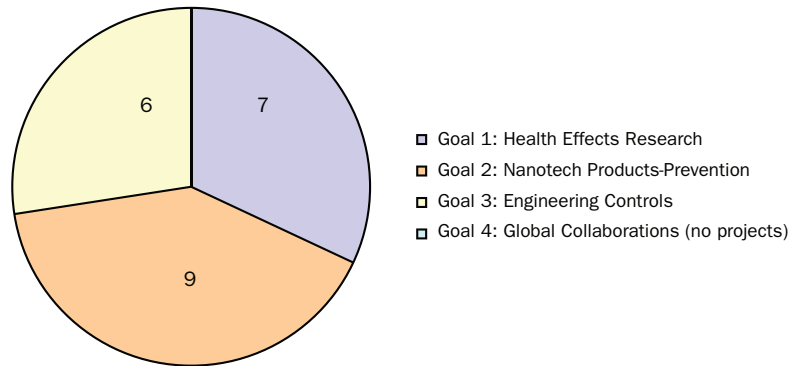

**Figure 3.** NIOSH extramural nanotechnology projects by strategic goals.

#### Additional Information on Extramural Portfolio

From FY-01 to FY-04, OEP funded three R43/44 projects for a total funding commitment of about \$950K (Table 1).

In FY-05, NIOSH funded two nanotechnology research grants through the R01 Program Announcement (Table 1). OEP also began participating in RFAs for Nanotechnology Research Grants Investigating Environmental and Human Health Issues. For the first RFA, 83 applications were received and 19 were recommended for funding. Fourteen of these met NIOSH criteria for relevance to occupational safety and health. Five of these were in the competitive range for funding consideration and one was funded by NIOSH. EPA funded 14 projects and NSF funded two projects under this RFA.

In FY-06, 81 applications were received in response to the joint RFA on environmental and human health issues. Six of these met NIOSH criteria for relevance and three of these were in the competitive range for funding consideration. NIOSH was able to fund one application (Table 1). EPA funded 21 projects, NSF funded four and NIEHS funded three projects under this RFA. NIOSH also funded two SBIR grants on nanotechnology in FY-06.

In FY-07, NIOSH funded a three-year career development (mentored scientist) grant involving research on personal exposure to nanoparticles at the University of Iowa. In addition, a two-year exploratory/developmental research project was funded at Colorado State University. NIOSH also participated in RFA-ES-06-008 Manufactured Nanomaterials: Physico-chemical Principles of Biocompatibility and Toxicity, which was jointly sponsored by NIEHS, EPA and NIOSH.



In FY-08, NIOSH funded a major research grant (R01) from the joint RFA on Manufactured Nanomaterials (Physico-chemical Principles of Biocompatibility and Toxicity). This project is being conducted at the University of Iowa. NIOSH also funded a small research grant (R03) at Colorado State University and an SBIR grant at Nanoscale Materials, Inc., in Kansas.

In FY-09 and FY-10, nanotechnology-related research proposals submitted to standing program announcements were considered for funding. NIOSH plans to continue collaborative efforts with EPA/NCER, NSF, NIH/NIEHS, and other international agencies to support nanotechnology research with occupational safety and health implications. OEP will continue to consult with the NIOSH Nanotechnology Research Center regarding needs and future directions for nanotechnology research.

## Extramural Project Descriptions

Summaries of the extramural projects funded by NIOSH/OEP are included as part of this portfolio update. Contact information for the principal investigators of the projects is provided in Table 2 to encourage collaborative scientific efforts among researchers.

## Current NIOSH Nanotechnology-related Information

Extramural investigators interested in pursuing nanotechnology studies related to occupational health and safety can learn more about the interests of NIOSH in this area by visiting the following web pages:

- <http://www.cdc.gov/niosh/topics/nanotech/>
- <http://www.cdc.gov/niosh/topics/nanotech/research.html>
- <http://www2a.cdc.gov/niosh-nil/>

NIOSH has identified 10 critical topic areas to guide in addressing knowledge gaps, developing strategies, and providing recommendations. NIOSH's key role in conducting and partnering in research on occupational exposures to nanomaterials is noted in a new strategic plan under the National Nanotechnology Initiative.

Information on the NIOSH goal to transfer research findings, technologies and information into prevention practices and products in the workplace is provided at the website: <http://www.cdc.gov/niosh/r2p/>. This emphasis on Research to Practice (r2p) is intended to reduce occupationally-related illness and injury by increasing the use of findings from NIOSH-funded research in the workplace.

NIOSH conducts a wide range of efforts in the areas of research, guidance, information transfer, and public service. Additional information on the diverse activities of NIOSH can be found at the NIOSH home page (<http://www.cdc.gov/niosh/homepage.html>) and the program portfolio website (<http://www.cdc.gov/niosh/programs/>).

The Nanoscale Science, Engineering, and Technology (NSET) Subcommittee of the National Science and Technology Council's Committee on Technology, with support from the National Nanotechnology Coordination Office, has released a new NNI Strategic Plan as called for in the 21st Century Nanotechnology Research and Development Act (Public Law 108-153) of 2003. This plan updates and replaces the NNI Strategic Plan of December 2004 and is available at [http://www.nano.gov/NNI\\_Strategic\\_Plan\\_2007.pdf](http://www.nano.gov/NNI_Strategic_Plan_2007.pdf). NIOSH participates as a member organization on this subcommittee.



**Table 1. Extramural nanotechnology research funded by NIOSH, 2001-2011**

Grant number	Investigator	Institution	Project title	Start	End	1st year funding	Total funding
<b>Prior to FY-04 NIOSH SBIR</b>							
1R430H 007471-01	Hooker	Nanomaterials Research LLC, Longmont, CO	Novel Hydrogen Sulfide Sensors for Portable Monitors	9/30/2001	3/31/2002	—	—
2R440H 007471-02	Williams	Synkera Technologies Inc., Longmont, CO	Novel Hydrogen Sulfide Sensors for Portable Monitors	9/16/2003	9/15/2006	—	—
				Pre-FY-04 Total		\$473,400	\$849,995
<b>FY-04 NIOSH SBIR</b>							
1R430H 007963-01A1	Rajagopalan	Nanoscale Materials, Inc., Manhattan, KS	From Nanoparticles to Novel Protective Garments	9/1/2004	5/15/2005	—	—
				FY-04 Total		\$100,000	\$100,000
<b>FY-05 NIOSH R01 Program Announcement</b>							
1R010H0 08282-01A	Kagan	University of Pittsburgh	Lung Oxidative Stress/Inflammation by Carbon Nanotubes	7/1/2005	6/30/2009	—	—

(continued)

**Table 1 (Continued). Extramural nanotechnology research funded by NIOSH, 2001–2011**

Grant number	Investigator	Institution	Project title	Start	End	1st year funding	Total funding
<b>FY-05 Co-sponsored RFA (EPA STAR-2005-B1)</b>							
1R01OH008806-01	O'Shaughnessy	University of Iowa	Assessment Methods for Nanoparticles in the Workplace	7/1/2005	6/30/2008	—	—
1R01OH008807-01	Xiong	New York University School of Medicine	Monitoring and Characterizing Airborne Carbon Nanotube Particles	8/1/2005	7/31/2008	—	—
<b>FY-06 NIOSH SBIR</b>							
1R43OH008739-01	Thompson	Eltron Research Boulder, CO	Antistatic Paint with Silent Discharge	8/30/2006	8/30/2007	—	—
1R43OH008939-01	Deinger	Synkera Technologies Inc., Longmont, CO	New Nanostructured Sensor Arrays for Hydride Detection	8/1/2006	2/28/2007	—	—
<b>FY-06 Co-sponsored RFA (EPA G2006-STAR F1 to F7)</b>							
1R01OH009141-01	Dutta	Ohio State University	Role of Surface Chemistry in the Toxicological Properties of Manufactured Nanoparticles	9/1/2006	8/31/2009	—	—

(continued)





**Table 1 (Continued). Extramural nanotechnology research funded by NIOSH, 2001–2011**

Grant number	Investigator	Institution	Project title	Start	End	1st year funding	Total funding
5R01OH008173-05	Timchalk	Battelle Pacific Northwest Laboratories	Non-Invasive Biomonitoring of Pesticides	9/1/2006	8/31/2011	—	—
				FY-06 Total		\$1,144,713	\$1,553,935
<b>FY-07 NIOSH Exploratory/Developmental Research (R21) Program Announcement</b>							
1R21OH009114-01	Volckens	Colorado State University	A High-Flow Personal Sampler for Inhalable Aerosol	8/1/2007	7/31/2009	—	—
<b>FY-07 Career Development Grants (K01) Program Announcement</b>							
1K01OH009255-01	Peters	University of Iowa	Personal Exposure to Engineered Nanoparticles	9/1/2007	8/31/2010	—	—
				FY-07 Total		\$314,138	\$741,945
<b>FY-08 Co-sponsored RFA (NIEHS RFA-ES-06-008)</b>							
1R01OH009448-01	Grassian	University of Iowa	An Integrated Approach Toward Understanding the Toxicity of Inhaled Nanomaterials	4/1/2008	3/31/2012	—	—

(continued)

**Table 1 (Continued). Extramural nanotechnology research funded by NIOSH, 2001–2011**

Grant number	Investigator	Institution	Project title	Start	End	1st year funding	Total funding
<b>FY-08 NIOSH Small Research Grant (PAR-06-551) Program Announcement</b>							
1R03OH009381	Volckens	Colorado State University	A Personal Sampler for Assessing Inhaled Nanoparticle Exposures	7/1/2008	6/30/2010	—	—
<b>FY-08 NIOSH SBIR</b>							
2R44OH07963-02	Rajagopalan	Nanoscale Materials, Inc., Manhattan, KS	From Nanoparticles to Novel Protective Garments	7/1/2008	6/30/2010	—	—
						FY-08 Total	\$796,841 \$2,115,644
<b>FY-09 NIOSH SBIR</b>							
5R44OH08939-03	Deining	Synkera Technologies Inc.	New Nanostructured Sensing Arrays for Hydride Detection	9/1/2009	8/31/2011	—	—
5R44OH009026-03	Routkevitch	Synkera Technologies Inc.	Phase II: Advanced Personal Gas Detection for Mining Applications	9/1/2009	8/31/2011	—	—
						FY-09 Total	\$368,661 \$750,000

(continued)



**Table 1 (Continued). Extramural nanotechnology research funded by NIOSH, 2001–2011 (Continued)**

Grant number	Investigator	Institution	Project title	Start	End	1st year funding	Total funding
<b>FY-10 NIOSH Research Grant</b>							
2R01OH008282-05	Kagan	University of Pittsburgh	Carbon nanotube biodegradation by neutrophil myeloperoxidase	7/1/2010	6/30/2015	—	—
1R21OH009920-01	Peters	University of Iowa	Methods to Assess Personal Exposures to Airborne Metallic Nanoparticles	9/1/2010	8/30/2012	—	—
1R01OH009801-01A1	Cheng	Lovelace Biomedical and Envir. Res. Inst.	Development of a personal sampler for nanoparticles	9/1/2010	8/31/2013	—	—
5R01OH09644-02	Mason	Michigan State University	Autonomous electrochemical gas detection microsystem for mine safety	9/1/2010	8/31/2014	—	—
						FY-10 Total	\$2,497,499
						FY-10 Total	\$5,118,191
<b>FY-11 NIOSH Research Grant</b>							
1R21OH009970-01	Delouise	University of Rochester	Reagents to Enhance Detection of Raw and Biologically Transformed Nanomaterials	9/1/2011	8/31/2013	—	—
						FY-11 Total	\$185,108
						FY-11 Total	\$402,956

(continued)

**Table 1 (Continued). Extramural nanotechnology research funded by NIOSH, 2001–2011**

Grant number	Investigator	Institution	Project title	Start	End	1st year funding	Total funding
					Total NIOSH Extramural Nanotechnology Funding	–	\$13,870,574



## Extramural Nanotechnology Research Project Summaries

The project summaries included here were either publicly available information from the NIH RePORTER database (<http://projectreporter.nih.gov/>) or obtained by the principal investigator. For projects that have ended, abstracts from the Final Reports are included. For additional information, please contact the Office of Extramural Programs. Investigator contact information is provided in Table 2 to encourage collaborative scientific efforts between researchers. Contact information for Dr. Hooker was not available. Project summaries are listed in the order they appear in Table 1.

### **HOOKER 7471 (R43) Novel Hydrogen Sulfide Sensors for Portable Monitors**

#### ***Final Report Abstract***

During this SBIR Phase I project, Nanomaterials Research (NRLLC) successfully demonstrated a new type of sensor device for detecting hydrogen sulfide (H<sub>2</sub>S). This gas is extremely toxic at low concentrations, and workplace exposure is common in a number of industries. Improved sensors and gas detection instruments are sorely needed to ensure protection of these exposed workers and to reduce H<sub>2</sub>S emissions into the atmosphere, thereby affecting public health.

NRLLC's new sensor device combines recent advances in both semiconductor materials and alternative sensor fabrication approaches. These novel components were produced using processes and architectures that are similar to those used in the manufacture of multilayer ceramic capacitors. The sensors had a footprint of only 0.45 cm × 0.30 cm and exhibited the requisite mechanical strength needed for handling and integration into traditional electronic packages.

The sensors responded well to H<sub>2</sub>S at concentrations ranging from 5 to 50 ppm. These levels are commensurate with the monitoring requirements for workplace exposures, in which the personal exposure limit, or PEL, is 10 ppm and the short-term exposure limit, or STEL, is 15 ppm. The sensors exhibited a large decrease in resistance when the toxic gas was present, which is characteristic of n-type semiconductor behavior. This response was found to be linear with concentration and repeatable during multiple exposures. Response times (t<sub>50</sub>) were on the order of 20 seconds.

Several variables were investigated to determine their effect on the sensor response and recovery. These included the composition of the sensor material, the operating temperature of the device, the particle size of the raw materials, the design of the multilayer structure, and the degree of porosity retained in the final device. While a more extensive study is required, the Phase I results suggest that the processing and operation of the devices can be optimized by controlling such variables, thereby ensuring reliable gas detection. In addition, such devices can be designed to meet specific instrumentation requirements.

The small size and tailorability of NRLLC's sensor devices are important features for implementation of the sensors in gas detection instruments. NRLLC envisions

a number of different application scenarios for these sensors including their use in stationary industrial monitoring systems, hand-held detection equipment, and revolutionary new personal monitors based on smart card technology. During the Phase II program, NRLLC plans to explore all three application areas, while building on the Phase I results to optimize sensor performance.

### **WILLIAMS 7471 (R44) Novel Hydrogen Sulfide Sensors for Portable Monitors**

#### ***Final Report Abstract***

Synkera's primary objective for this SBIR project was the design, development, and demonstration of a better sensor technology for the detection of hydrogen sulfide. Hydrogen sulfide is a colorless, flammable gas that is highly toxic. It reacts with the enzymes in the blood that inhibit cell respiration. At high concentrations, it can literally shut off the lungs, while lower levels can burn the respiratory tract and cause eye irritation. This gas is encountered in a wide range of industries, and a number of standards have been established for occupational exposure. The OSHA Permissible Exposure Limit (PEL) is 10 ppm, the Short Term Exposure Limit (STEL) is 15 ppm, and exposures of 300 ppm or greater are considered immediately dangerous to life and health (IDLH). Because of the potential for adverse health effects at low concentrations, the industrial hygiene community is continually seeking improved performance from hydrogen sulfide sensors. Specific requirements include reliable and accurate detection in real time, quantitative measurement capabilities, low purchase and life cycle costs, and low power consumption (for portability). Sensors meeting these requirements will find numerous applications within the health and safety field. In addition, there are several potential spin-off opportunities in leak detection, emission monitoring, and process control. Synkera's approach is to utilize alternative ceramic oxide materials, and a unique multilayer fabrication process to accomplish the objectives of this project. The work plan includes optimization of the sensor materials, sensor element fabrication, sensor element packaging, in-house and external evaluation of the sensors, and establishing the foundation for new instrument development. The ultimate aim is a low-cost, low-power sensor that can be used in a new type of personal monitor. The envisioned monitor is a low profile, credit card sized "smart-card" that can not only alert the wearer when unsafe concentrations have been encountered but also track cumulative individual worker exposure to a particular toxic gas species.

### **RAJAGOPALAN 7963 (R43) From Nanoparticles to Novel Protective Garments**

The goal of this project is to develop breathable, lightweight and disposable chemical protective clothing for use by personnel associated with law enforcement agencies, emergency medical services, medical/triage facilities, and other federal, state, or local emergency agencies as well as by fire fighters and civilian first responders. This goal will be accomplished by producing a lightweight, chemical protective garment material, having a limited number of distinct layers, which in turn can be assembled into a breathable, protective garment wherein the particular layers impart at least one key property to the composite material. Non-breathable materials retard the human body's process of heat dissipation normally achieved through the evaporation of



perspiration. Without significant transmission of water vapor, or breathability, prolonged use of non-breathable materials can result in intolerable discomfort and even death to a person wearing garments made from these materials. The novelty of the proposed approach is the development of granulated reactive NanoActive(r) sorbents containing composite layered textile material that protects the sorbent from contact with and contamination by liquids and that has good vapor permeability, thus providing for passage of air and water vapor as well as sorption of harmful and noxious vapors and gases. Based on the outcome of Phase I research, it is clear that granulated mixed metal oxide nano-formulations are required for a broad-spectrum reactivity. As a result, this Phase II project will begin by developing methodologies for granulation of mixed metal oxides based on NanoActive materials. This will be followed by performance screening of formulations against toxic industrial chemicals and chemical warfare agent simulants by a breakthrough testing procedure. The down selected formulations will then be incorporated into down selected textile materials with optimum air and water vapor permeable properties. Next, these composite fabric test swatches will be evaluated for a number of criteria using industry recognized ASTM test methods. The top four granulated nanoparticles-embedded fabrics will be tested for chemical resistance against four toxic chemicals by means of a standard ASTM procedure. The project will conclude by pilot studies involving scale-up of granulated nanoparticles and composite textile preparation followed by production of prototype chemical protective clothing. Public Health Relevance: A major deficiency of the available chemical protective garments is the failure to provide desired levels of toxic vapor sorption and still maintain sufficient transfer of heat and moisture to keep a wearer cool and comfortable. Permeable textiles containing highly reactive NanoActive® materials offer promise of protection and comfort.

## **KAGAN 8282 (R01) Lung Oxidative Stress/Inflammation by Carbon Nanotubes**

### **Background**

Specific Aim 1 is to establish the extent to which SWCNT alone are pro-inflammatory to lung cells and tissue and characterize the role of iron in these effects using genetically manipulated cells and animals as well as antioxidant interventions.

Specific Aim 2 is to determine the potential for SWCNT and microbial stimuli to synergistically interact to promote macrophage activation, oxidative stress, and lung inflammation.

Specific Aim 3 is to reveal the extent to which SWCNT are effective in inducing apoptosis and whether apoptotic cells exert their macrophage-dependent anti-inflammatory potential during *in vitro* and *in vivo* SWCNT exposure. The project involves a team of interdisciplinary scientists with expertise in redox chemistry/biochemistry, cell and molecular biology of inflammation and its interactions with microbial agents and pulmonary toxicology of nanoparticles.



**Peer-reviewed publications specifically credited to this project:**

The role of nanotoxicology in realizing the ‘helping without harm’ paradigm of nanomedicine: lessons from studies of pulmonary effects of single-walled carbon nanotubes. Shvedova AA, Kagan VE. *J Intern Med.* 2010; 267(1):106–18.

Abstract: Nano-sized materials and nano-scaled processes are widely used in many industries. They are being actively introduced as diagnostic and therapeutic in biomedicine and they are found in numerous consumer products. The small size of nanoparticles, comparable with molecular machinery of cells, may affect normal physiological functions of cells and cause cytotoxicity. Their toxic potential cannot be extrapolated from studies of larger particles due to unique physicochemical properties of nanomaterials. Therefore, the use of nanomaterials may pose unknown risks to human health and the environment. This review discusses several important issues relevant to pulmonary toxicity of nanoparticles, especially single-walled carbon nanotubes (SW-CNT), their direct cytotoxic effects, their ability to cause an inflammatory response, and induce oxidative stress upon pharyngeal aspiration or inhalation. Further, recognition and engulfment of nanotubes by macrophages as they relate to phagocytosis and bio-distribution of nanotubes in tissues and circulation are discussed. The immunosuppressive effects of CNT and their significance in increased sensitivity of exposed individuals to microbial infections are summarized. Finally, data on biodegradation of SWCNT by oxidative enzymes of inflammatory cells are presented in lieu of their persistence and distribution in the body.

Lipid accumulation and dendritic cell dysfunction in cancer. Herber DL, Cao W, Nefedova Y, Novitskiy SV, Nagaraj S, Tyurin VA, Corzo A, Cho HI, Celis E, Lennox B, Knight SC, Padhya T, McCaffrey TV, McCaffrey JC, Antonia S, Fishman M, Ferris RL, Kagan VE, Gabilovich DI. *Nat Med.* 2010;16(8):880–6.

Abstract: Dendritic cells (DCs), a type of professional antigen-presenting cells, are responsible for initiation and maintenance of immune responses. Here we report that a substantial proportion of DCs in tumor-bearing mice and people with cancer have high amounts of triglycerides as compared with DCs from tumor-free mice and healthy individuals. In our studies, lipid accumulation in DCs was caused by increased uptake of extracellular lipids due to upregulation of scavenger receptor A. DCs with high lipid content were not able to effectively stimulate allogeneic T cells or present tumor-associated antigens. DCs with high and normal lipid levels did not differ in expression of major histocompatibility complex and co-stimulatory molecules. However, lipid-laden DCs had a reduced capacity to process antigens. Pharmacological normalization of lipid abundance in DCs with an inhibitor of acetyl-CoA carboxylase restored the functional activity of DCs and substantially enhanced the effects of cancer vaccines. These findings suggest that immune responses in cancer can be improved by manipulating the lipid levels in DCs.

Close encounters of the small kind: adverse effects of man-made materials interfacing with the nano-cosmos of biological systems. Shvedova AA, Kagan VE, Fadeel B. *Annu Rev Pharmacol Toxicol.*, 2010; 50:63–88.



**Abstract:** Engineered nanomaterials have unique physico-chemical properties that make them promising for many technological and biomedical applications, including tissue regeneration, drug and gene delivery, and *in vivo* monitoring of disease processes. However, with the burgeoning capabilities to manipulate structures at the nano-scale, intentional as well as unintentional human exposures to engineered nanomaterials are set to increase. Nanotoxicology is an emerging discipline focused on understanding the properties of engineered nanomaterials and their interactions with biological systems, and may be viewed as the study of the undesirable interference between man-made nanomaterials and cellular nanostructures or nanomachines. In this review, we discuss recognition of engineered nanomaterials by the immune system, our primary defense system against foreign invasion. Moreover, as oxidative stress is believed to be one of the major deleterious consequences of exposure to nanomaterials, we explore triggering of pro- and antioxidant pathways as well as biomarkers of oxidative stress. Finally, we highlight *in vivo* studies of the toxicological outcomes of engineered nanomaterials, including carbon nanotubes, with an emphasis on inflammation and genotoxic responses.

Mechanistic investigations of horseradish peroxidase-catalyzed degradation of single-walled carbon nanotubes. Allen BL, Kotchey GP, Chen Y, Yanamala NV, Klein-Seetharaman J, Kagan VE, Star A. *J Am Chem Soc.* 2009;131(47):17194–205.

**Abstract:** Single-walled carbon nanotubes (SWNTs) have been investigated for a variety of applications including composite materials, electronics, and drug delivery. However, these applications may be compromised depending on the negative effects of SWNTs to living systems. While reports of toxicity induced by SWNTs vary, means to alleviate or quell these effects are in small abundance. We have reported recently the degradation of carboxylated SWNTs through enzymatic catalysis with horseradish peroxidase (HRP). In this full Article, we investigated the degradation of both carboxylated and pristine SWNTs with HRP and compared these results with chemical degradation by hemin and  $\text{FeCl}_3$ . The interaction between pristine and carboxylated SWNTs with HRP was further studied by computer modeling, and the products of the enzymatic degradation were identified. By examining these factors with both pristine and carboxylated SWNTs through a variety of techniques including atomic force microscopy (AFM), transmission electron microscopy (TEM), Raman spectroscopy, ultraviolet-visible-near-infrared (UV-vis-NIR) spectroscopy, gas chromatography-mass spectrometry (GC-MS), high-performance liquid chromatography (HPLC), and liquid chromatography-mass spectrometry (LC-MS), degradation pathways were elucidated. It was observed that pristine SWNTs demonstrate no degradation with HRP incubation but display significant degradation when incubated with either hemin or  $\text{FeCl}_3$ . Such data signify a heterolytic cleavage of  $\text{H}_2\text{O}_2$  with HRP as pristine nanotubes do not degrade, whereas Fenton catalysis results in the homolytic cleavage of  $\text{H}_2\text{O}_2$  producing free radicals that oxidize pristine SWNTs. Product analysis shows complete degradation produces  $\text{CO}_2$  gas. Conversely, incomplete degradation results in the formation of different oxidized aromatic hydrocarbons.

Mass-spectrometric analysis of hydroperoxy- and hydroxy-derivatives of cardiolipin and phosphatidylserine in cells and tissues induced by pro-apoptotic and pro-inflammatory stimuli. Tyurin VA, Tyurina YY, Jung MY, Tungekar MA, Wasserloos KJ, Bayir H, Greenberger JS, Kochanek PM, Shvedova AA, Pitt B, Kagan VE. *J Chromatogr B Analyt Technol Biomed Life Sci.* 2009;877(26):2863–72.

Abstract: Oxidation of two anionic phospholipids—cardiolipin (CL) in mitochondria and phosphatidylserine (PS) in extramitochondrial compartments—is important signaling event, particularly during the execution of programmed cell death and clearance of apoptotic cells. Quantitative analysis of CL and PS oxidation products is central to understanding their molecular mechanisms of action. We combined the identification of diverse phospholipid molecular species by ESI-MS with quantitative assessments of lipid hydroperoxides using a fluorescence HPLC-based protocol. We characterized CL and PS oxidation products formed in a model system (cyt *c*/H<sub>2</sub>O<sub>2</sub>), in apoptotic cells (neurons, pulmonary artery endothelial cells) and mouse lung under inflammatory/oxidative stress conditions (hyperoxia, inhalation of single walled carbon nanotubes). Our results demonstrate the usefulness of this approach for quantitative assessments, identification of individual molecular species and structural characterization of anionic phospholipids that are involved in oxidative modification in cells and tissues.

Recognition of live phosphatidylserine-labeled tumor cells by dendritic cells: a novel approach to immunotherapy of skin cancer. Shurin MR, Potapovich AI, Tyurina YY, Tourkova IL, Shurin GV, Kagan VE. *Cancer Res.* 2009; 69(6):2487–96.

Abstract: Dendritic cells (DC) loaded with tumor antigens from apoptotic/necrotic tumor cells are commonly used as vaccines for cancer therapy. However, the use of dead tumor cells may cause both tolerance and immunity, making the effect of vaccination unpredictable. To deliver live tumor “cargoes” into DC, we developed a new approach based on the “labeling” of tumors with a phospholipid “eat-me” signal, phosphatidylserine. Expression of phosphatidylserine on live tumor cells mediated their recognition and endocytosis by DC resulting in the presentation of tumor antigens to antigen-specific T cells. In mice, topical application of phosphatidylserine-containing ointment over melanoma induced tumor-specific CTL, local and systemic antitumor immunity, and inhibited tumor growth. Thus, labeling of tumors with phosphatidylserine is a promising strategy for cancer immunotherapy.

Single-walled carbon nanotubes impair human macrophage engulfment of apoptotic cell corpses. Witasp E, Shvedova AA, Kagan VE, Fadeel B. *Inhal Toxicol.* 2009; 21 Suppl 1:131–6.

Abstract: Single-walled carbon nanotubes (SWCNT) are being produced in increasing quantities and the application of these materials in a large number of new technologies and consumer products necessitates studies of their potential impact on human health and the environment. To determine whether SWCNT affect viability or function of macrophages, important components of the innate immune system,



we performed *in vitro* studies using primary human monocyte-derived macrophages (HMDM). Our findings show that SWCNT with a low content of metal impurities do not exert direct cytotoxic effects on HMDM. However, SWCNT suppressed chemotaxis of primary human monocytes in a standard chemotaxis assay. Moreover, macrophage engulfment of apoptotic target cells was significantly impaired following pre-incubation of HMDM with SWCNT at non-cytotoxic concentrations. These results are in line with previous studies showing that ultrafine carbon particles and carbon nanotubes may impair alveolar macrophage ingestion of microorganisms, and suggest that tissue homeostasis may be compromised by SWCNT due to suppressive effects on macrophages.

Phosphatidylserine targets single-walled carbon nanotubes to professional phagocytes *in vitro* and *in vivo*. Konduru NV, Tyurina YY, Feng W, Basova LV, Belikova NA, Bayir H, Clark K, Rubin M, Stolz D, Vallhov H, Scheynius A, Witasp E, Fadeel B, Kichambare PD, Star A, Kisin ER, Murray AR, Shvedova AA, Kagan VE. *PLoS One*. 2009;4(2):e4398. Epub 2009 Feb 9. Erratum in: *PLoS One*. 2009; 4(5):10.1371/annotation/1801d3b3-2082-4eb7-913b-b93e1fe4c219.

Abstract: Broad applications of single-walled carbon nanotubes (SWCNT) dictate the necessity to better understand their health effects. Poor recognition of non-functionalized SWCNT by phagocytes is prohibitive towards controlling their biological action. We report that SWCNT coating with a phospholipid “eat-me” signal, phosphatidylserine (PS), makes them recognizable *in vitro* by different phagocytic cells—murine RAW264.7 macrophages, primary monocyte-derived human macrophages, dendritic cells, and rat brain microglia. Macrophage uptake of PS-coated nanotubes was suppressed by the PS-binding protein, Annexin V, and endocytosis inhibitors, and changed the pattern of pro- and anti-inflammatory cytokine secretion. Loading of PS-coated SWCNT with pro-apoptotic cargo (cytochrome c) allowed for the targeted killing of RAW264.7 macrophages. *In vivo* aspiration of PS-coated SWCNT stimulated their uptake by lung alveolar macrophages in mice. Thus, PS-coating can be utilized for targeted delivery of SWCNT with specified cargoes into professional phagocytes, hence for therapeutic regulation of specific populations of immune-competent cells.

Oxidative stress and inflammatory response in dermal toxicity of single-walled carbon nanotubes. Murray AR, Kisin E, Leonard SS, Young SH, Kommineni C, Kagan VE, Castranova V, Shvedova AA. *Toxicology*. 2009;257(3):161–71.

Abstract: Single-walled carbon nanotubes (SWCNT) represent a novel material with unique electronic and mechanical properties. The extremely small size (approximately 1 nm diameter) renders their chemical and physical properties unique. A variety of different techniques are available for the production of SWCNT; however, the most common is via the disproportionation of gaseous carbon molecules supported on catalytic iron particles (high-pressure CO conversion, HiPCO). The physical nature of SWCNT may lead to dermal penetration following deposition on exposed skin. This dermal deposition provides a route of exposure which is important

to consider when evaluating SWCNT toxicity. The dermal effects of SWCNT are largely unknown. We hypothesize that SWCNT may be toxic to the skin. We further hypothesize that SWCNT toxicity may be dependent upon the metal (particularly iron) content of SWCNT via the metal's ability to interact with the skin, initiate oxidative stress, and induce redox-sensitive transcription factors thereby affecting/leading to inflammation. To test this hypothesis, the effects of SWCNT were assessed both *in vitro* and *in vivo* using EpiDerm FT engineered skin, murine epidermal cells (JB6 P+), and immune-competent hairless SKH-1 mice. Engineered skin exposed to SWCNT showed increased epidermal thickness and accumulation and activation of dermal fibroblasts which resulted in increased collagen as well as release of pro-inflammatory cytokines. Exposure of JB6 P+ cells to unpurified SWCNT (30% iron) resulted in the production of ESR detectable hydroxyl radicals and caused a significant dose-dependent activation of AP-1. No significant changes in AP-1 activation were detected when partially purified SWCNT (0.23% iron) were introduced to the cells. However, NFkappaB was activated in a dose-dependent fashion by exposure to both unpurified and partially purified SWCNT. Topical exposure of SKH-1 mice (5 days, with daily doses of 40 microg/mouse, 80 microg/mouse, or 160 microg/mouse) to unpurified SWCNT caused oxidative stress, depletion of glutathione, oxidation of protein thiols and carbonyls, elevated myeloperoxidase activity, an increase of dermal cell numbers, and skin thickening resulting from the accumulation of polymorphonuclear leukocytes (PMNs) and mast cells. Altogether, these data indicated that topical exposure to unpurified SWCNT, induced free radical generation, oxidative stress, and inflammation, thus causing dermal toxicity.

Mechanisms of pulmonary toxicity and medical applications of carbon nanotubes: Two faces of Janus? Shvedova AA, Kisin ER, Porter D, Schulte P, Kagan VE, Fadeel B, Castranova V. *Pharmacol Ther.* 2009 Feb;121(2):192–204.

Abstract: Nanotechnology is an emerging science involving manipulation of materials at the nanometer scale. There are several exciting prospects for the application of engineered nanomaterials in medicine. However, concerns over adverse and unanticipated effects on human health have also been raised. In fact, the same properties that make engineered nanomaterials attractive from a technological and biomedical perspective could also make these novel materials harmful to human health and the environment. Carbon nanotubes are cylinders of one or several coaxial graphite layer(s) with a diameter in the order of nanometers, and serve as an instructive example of the Janus-like properties of nanomaterials. Numerous *in vitro* and *in vivo* studies have shown that carbon nanotubes and/or associated contaminants or catalytic materials that arise during the production process may induce oxidative stress and prominent pulmonary inflammation. Recent studies also suggest some similarities between the pathogenic properties of multi-walled carbon nanotubes and those of asbestos fibers. On the other hand, carbon nanotubes can be readily functionalized and several studies on the use of carbon nanotubes as versatile excipients for drug delivery and imaging of disease processes have been reported, suggesting that carbon nanotubes may have a place in the armamentarium for treatment and monitoring of cancer, infection, and other disease conditions. Nanomedicine is an emerging field that holds great promise;





however, close attention to safety issues is required to ensure that the opportunities that carbon nanotubes and other engineered nanoparticles offer can be translated into feasible and safe constructs for the treatment of human disease.

Mitochondria-targeted disruptors and inhibitors of cytochrome *c*/cardiolipin peroxidase complexes: a new strategy in anti-apoptotic drug discovery. Kagan VE, Bayir A, Bayir H, Stoyanovsky D, Borisenko GG, Tyurina YY, Wipf P, Atkinson J, Greenberger JS, Chapkin RS, Belikova NA. *Mol Nutr Food Res*. 2009;53(1):104–14.

Abstract: The critical role of mitochondria in programmed cell death leads to the design of mitochondriotropic agents as a strategy in regulating apoptosis. For anticancer therapy, stimulation of proapoptotic mitochondrial events in tumor cells and their suppression in surrounding normal cells represents a promising paradigm for new therapies. Different approaches targeting regulation of components of mitochondrial antioxidant system such as Mn-SOD demonstrated significant antitumor efficiency, particularly in combination therapy. This review is focused on a newly discovered early stage of mitochondria-dependent apoptosis-oxidative lipid signaling involving a mitochondria-specific phospholipid cardiolipin (CL). Cytochrome *c* (cyt *c*) acts as a CL-specific peroxidase very early in apoptosis. At this stage, the hostile events are still secluded within the mitochondria and do not reach the cytosolic targets. CL oxidation process is required for the release of pro-apoptotic factors into the cytosol. Manipulation of cyt *c* interactions with CL, inhibition of peroxidase activity, and prevention of CL peroxidation are prime targets for the discovery of anti-apoptotic drugs acting before the “point-of-no-return” in the fulfillment of the cell death program. Therefore, mitochondria-targeted disruptors and inhibitors of cyt *c*/CL peroxidase complexes and suppression of CL peroxidation represent new strategies in anti-apoptotic drug discovery.

Biodegradation of single-walled carbon nanotubes through enzymatic catalysis. Allen BL, Kichambare PD, Gou P, Vlasova II, Kapralov AA, Konduru N, Kagan VE, Star A. *Nano Lett*. 2008; 8(11):3899–903.

Abstract: We show here the biodegradation of single-walled carbon nanotubes through natural, enzymatic catalysis. By incubating nanotubes with a natural horseradish peroxidase (HRP) and low concentrations of H<sub>2</sub>O<sub>2</sub> (approximately 40 microM) at 4 degrees C over 12 weeks under static conditions, we show the increased degradation of nanotube structure. This reaction was monitored via multiple characterization methods, including transmission electron microscopy (TEM), dynamic light scattering (DLS), gel electrophoresis, mass spectrometry, and ultraviolet-visible-near-infrared (UV-vis-NIR) spectroscopy. These results mark a promising possibility for carbon nanotubes to be degraded by HRP in environmentally relevant settings. This is also tempting for future studies involving biotechnological and natural (plant peroxidases) ways for degradation of carbon nanotubes in the environment.

Inhalation vs. aspiration of single-walled carbon nanotubes in C57BL/6 mice: inflammation, fibrosis, oxidative stress, and mutagenesis. Shvedova AA, Kisin E, Murray AR, Johnson VJ, Gorelik O, Arepalli S, Hubbs AF, Mercer RR, Keohavong P, Sussman N,

Jin J, Yin J, Stone S, Chen BT, Deye G, Maynard A, Castranova V, Baron PA, Kagan VE. *Am J Physiol Lung Cell Mol Physiol*. 2008; 295(4):L552–65.

**Abstract:** Nanomaterials are frontier technological products used in different manufactured goods. Because of their unique physicochemical, electrical, mechanical, and thermal properties, single-walled carbon nanotubes (SWCNT) are finding numerous applications in electronics, aerospace devices, computers, and chemical, polymer, and pharmaceutical industries. SWCNT are relatively recently discovered members of the carbon allotropes that are similar in structure to fullerenes and graphite. Previously, we (47) have reported that pharyngeal aspiration of purified SWCNT by C57BL/6 mice caused dose-dependent granulomatous pneumonia, oxidative stress, acute inflammatory/cytokine responses, fibrosis, and decrease in pulmonary function. To avoid potential artifactual effects due to instillation/agglomeration associated with SWCNT, we conducted inhalation exposures using stable and uniform SWCNT dispersions obtained by a newly developed aerosolization technique (2). The inhalation of nonpurified SWCNT (iron content of 17.7% by weight) at 5 mg/m<sup>3</sup>, 5 h/day for 4 days was compared with pharyngeal aspiration of varying doses (5–20 microg per mouse) of the same SWCNT. The chain of pathological events in both exposure routes was realized through synergized interactions of early inflammatory response and oxidative stress culminating in the development of multifocal granulomatous pneumonia and interstitial fibrosis. SWCNT inhalation was more effective than aspiration in causing inflammatory response, oxidative stress, collagen deposition, and fibrosis as well as mutations of K-ras gene locus in the lung of C57BL/6 mice.

Increased accumulation of neutrophils and decreased fibrosis in the lung of NADPH oxidase-deficient C57BL/6 mice exposed to carbon nanotubes. Shvedova AA, Kisin ER, Murray AR, Kommineni C, Castranova V, Fadeel B, Kagan VE. *Toxicol Appl Pharmacol*. 2008; 231(2):235–40.

**Abstract:** Single-walled carbon nanotubes (SWCNT) have been introduced into a large number of new technologies and consumer products. The combination of their exceptional features with very broad applications raised concerns regarding their potential health effects. The prime target for SWCNT toxicity is believed to be the lung where exposure may occur through inhalation, particularly in occupational settings. Our previous work has demonstrated that SWCNT cause robust inflammatory responses in rodents with very early termination of the acute phase and rapid onset of chronic fibrosis. Timely elimination of polymorphonuclear neutrophils (PMNs) through apoptosis and their subsequent clearance by macrophages is a necessary stage in the resolution of pulmonary inflammation whereby NADPH oxidase contributes to control of apoptotic cell death and clearance of PMNs. Thus, we hypothesized that NADPH oxidase may be an important regulator of the transition from the acute inflammation to the chronic fibrotic stage in response to SWCNT. To experimentally address the hypothesis, we employed NADPH oxidase-deficient mice which lack the gp91(phox) subunit of the enzymatic complex. We found that NADPH oxidase null mice responded to SWCNT exposure with a marked accumulation of PMNs and elevated levels of apoptotic cells in the lungs, production of pro-inflammatory cytokines,





decreased production of the anti-inflammatory and pro-fibrotic cytokine, TGF-beta, and significantly lower levels of collagen deposition, as compared to C57BL/6 control mice. These results demonstrate a role for NADPH oxidase-derived reactive oxygen species in determining course of pulmonary response to SWCNT.

Sequential exposure to carbon nanotubes and bacteria enhances pulmonary inflammation and infectivity. Shvedova AA, Fabisiak JP, Kisin ER, Murray AR, Roberts JR, Tyurina YY, Antonini JM, Feng WH, Kommineni C, Reynolds J, Barchowsky A, Castanova V, Kagan VE. *Am J Respir Cell Mol Biol.* 2008; 38(5):579–90.

Abstract: Carbon nanotubes (CNT), with their applications in industry and medicine, may lead to new risks to human health. CNT induce a robust pulmonary inflammation and oxidative stress in rodents. Realistic exposures to CNT may occur in conjunction with other pathogenic impacts (microbial infections) and trigger enhanced responses. We evaluated interactions between pharyngeal aspiration of single-walled CNT (SWCNT) and bacterial pulmonary infection of C57BL/6 mice with *Listeria monocytogenes* (LM). Mice were given SWCNT (0, 10, and 40 mug/mouse) and 3 days later were exposed to LM ( $10^3$  bacteria/mouse). Sequential exposure to SWCNT/LM amplified lung inflammation and collagen formation. Despite this robust inflammatory response, SWCNT pre-exposure significantly decreased the pulmonary clearance of LM-exposed mice measured 3 to 7 days after microbial infection versus PBS/LM-treated mice. Decreased bacterial clearance in SWCNT-pre-exposed mice was associated with decreased phagocytosis of bacteria by macrophages and a decrease in nitric oxide production by these phagocytes. Pre-incubation of naïve alveolar macrophages with SWCNT *in vitro* also resulted in decreased nitric oxide generation and suppressed phagocytizing activity toward LM. Failure of SWCNT-exposed mice to clear LM led to a continued elevation in nearly all major chemokines and acute phase cytokines into the later course of infection. In SWCNT/LM-exposed mice, bronchoalveolar lavage neutrophils, alveolar macrophages, and lymphocytes, as well as lactate dehydrogenase level, were increased compared with mice exposed to SWCNT or LM alone. In conclusion, enhanced acute inflammation and pulmonary injury with delayed bacterial clearance after SWCNT exposure may lead to increased susceptibility to lung infection in exposed populations.

The hierarchy of structural transitions induced in cytochrome c by anionic phospholipids determines its peroxidase activation and selective peroxidation during apoptosis in cells. Kapralov AA, Kurnikov IV, Vlasova II, Belikova NA, Tyurin VA, Basova LV, Zhao Q, Tyurina YY, Jiang J, Bayir H, Vladimirov YA, Kagan VE. *Biochemistry.* 2007;46(49):14232–44.

Abstract: Activation of peroxidase catalytic function of cytochrome c (cyt c) by anionic lipids is associated with destabilization of its tertiary structure. We studied effects of several anionic phospholipids on the protein structure by monitoring (1) Trp59 fluorescence, (2) Fe-S(Met80) absorbance at 695 nm, and (3) EPR of heme nitrosylation. Peroxidase activity was probed using several substrates and protein-derived radicals. Peroxidase activation of cyt c did not require complete protein unfolding or breakage

of the Fe-S(Met80) bond. The activation energy of cyt c peroxidase changed in parallel with stability energies of structural regions of the protein probed spectroscopically. Cardiolipin (CL) and phosphatidic acid (PA) were most effective in inducing cyt c peroxidase activity. Phosphatidylserine (PS) and phosphatidylinositol bisphosphate (PIP2) displayed a significant but much weaker capacity to destabilize the protein and induce peroxidase activity. Phosphatidylinositol trisphosphate (PIP3) appeared to be a stronger inducer of cyt c structural changes than PIP2, indicating a role for the negatively charged extra phosphate group. Comparison of cyt c-deficient HeLa cells and mouse embryonic cells with those expressing a full complement of cyt c demonstrated the involvement of cyt c peroxidase activity in selective catalysis of peroxidation of CL, PS, and PI, which corresponded to the potency of these lipids in inducing cyt c's structural destabilization.

Single-walled carbon nanotubes: geno- and cytotoxic effects in lung fibroblast V79 cells. Kisin ER, Murray AR, Keane MJ, Shi XC, Schwegler-Berry D, Gorelik O, Arepalli S, Castranova V, Wallace WE, Kagan VE, Shvedova AA. *J Toxicol Environ Health A*. 2007;70(24):2071–9.

Abstract: With the development of nanotechnology, there is a tremendous growth of the application of nanomaterials, which increases the risk of human exposure to these nanomaterials through inhalation, ingestion, and dermal penetration. Among different types of nanoparticles, single-walled carbon nanotubes (SWCNT) with extremely small size (1 nm in diameter) exhibit extraordinary properties and offer possibilities to create materials with astounding features. Since the release of nanoparticles in an enclosed environment is of great concern, a study of possible genotoxic effects is important. Our previous data showed that pharyngeal aspiration of SWCNT elicited pulmonary effects in C57BL/6 mice that was promoted by a robust, acute inflammatory reaction with early onset resulting in progressive interstitial fibrogenic response and the formation of granulomas. In the present study, the genotoxic potential of SWCNT was evaluated *in vitro*. The genotoxic effects of nanoparticles were examined using three different test systems: the comet assay and micronucleus (MN) test in a lung fibroblast (V79) cell line, and the Salmonella gene mutation assay in strains YG1024/YG1029. Cytotoxicity tests showed loss of viability in a concentration- and time-dependent manner after exposure of cells to SWCNT. Results from the comet assay demonstrated the induction of DNA damage after only 3 h of incubation with 96 microg/cm<sup>2</sup> of SWCNT. The MN test indicated some but not significant micronucleus induction by SWCNT in the V79 cell line at the highest concentrations tested. With two different strains of Salmonella typhimurium, no mutations were found following SWCNT exposure.

Sequential Exposure to Carbon Nanotubes and Bacteria Enhances Pulmonary Inflammation and Infectivity. *Am J Respir Cell Mol Biol*. 2007 Shvedova AA, Fabisiak JP, Kisin ER, Murray AR, Roberts JR, Tyurina YY, Antonini JM, Feng WH, Kommineni C, Reynolds J, Barchowsky A, Castranova V, Kagan VE.



**Abstract:** Realistic exposures to Carbon nanotubes (CNT) may occur in conjunction with other pathogenic impacts (microbial infections) and trigger enhanced responses. We evaluated interactions between pharyngeal aspiration of single walled CNT (SWCNT) and bacterial pulmonary infection of C57BL/6 mice with *Listeria monocytogenes* (LM). Mice were given SWCNT (0, 10 and 40 microg/mouse) and 3 days later exposed to LM ( $10^3$  bacteria/mouse). Sequential exposure to SWCNT/LM amplified lung inflammation and collagen formation. Despite this robust inflammatory response, SWCNT pre-exposure significantly decreased the pulmonary clearance of LM measured 3–7 days after microbial infection vs PBS/LM treated mice. Decreased bacterial clearance in SWCNT pre-exposed mice was associated with decreased phagocytosis of bacteria by macrophages and a decrease in nitric oxide production by these phagocytes. Pre-incubation of naive alveolar macrophages with SWCNT *in vitro* also resulted in decreased nitric oxide generation and suppressed phagocytizing activity towards LM. Failure of SWCNT-exposed mice to clear LM led to a continued elevation in nearly all major chemokines and acute phase cytokines into the later course of infection. In SWCNT/LM exposed mice, BAL PMNs, AMs and lymphocytes as well as LDH level were increased compared to mice exposed to SWCNT or LM alone. In conclusion, enhanced acute inflammation and pulmonary injury with delayed bacterial clearance after SWCNT exposure may lead to increased susceptibility to lung infection in exposed populations.

Vitamin E deficiency enhances pulmonary inflammatory response and oxidative stress induced by single-walled carbon nanotubes in C57BL/6 mice. *Toxicol Appl Pharmacol.* 221(3):339–348, 2007 Shvedova AA, Kisin ER, Murray AR, Gorelik O, Arepalli S, Castranova V, Young SH, Gao F, Tyurina YY, Oury TD, Kagan VE.

**Abstract:** Exposure of mice to single-walled carbon nanotubes (SWCNTs) induces an unusually robust pulmonary inflammatory response with an early onset of fibrosis, which is accompanied by oxidative stress and antioxidant depletion. The role of specific components of the antioxidant protective system, specifically vitamin E, the major lipid-soluble antioxidant, in the SWCNT-induced reactions has not been characterized. We used C57BL/6 mice, maintained on vitamin E-sufficient or vitamin E-deficient diets, to explore and compare the pulmonary inflammatory reactions to aspirated SWCNTs. The vitamin E-deficient diet caused a 90-fold depletion of alpha-tocopherol in the lung tissue and resulted in a significant decline of other antioxidants (GSH, ascorbate) as well as accumulation of lipid peroxidation products. A greater decrease of pulmonary antioxidants was detected in SWCNT-treated vitamin E-deficient mice as compared to controls. Lowered levels of antioxidants in vitamin E-deficient mice were associated with a higher sensitivity to SWCNT-induced acute inflammation (total number of inflammatory cells, number of polymorphonuclear leukocytes, released LDH, total protein content and levels of pro-inflammatory cytokines, TNF-alpha and IL-6) and enhanced profibrotic responses (elevation of TGF-beta and collagen deposition). Exposure to SWCNTs markedly shifted the ratio of cleaved to full-length extracellular superoxide dismutase (EC-SOD). Given that pulmonary levels of vitamin E can be manipulated through diet, its effects on SWCNT-induced inflammation may be of practical importance in optimizing protective strategies.

Nitrosative stress inhibits the aminophospholipid translocase resulting in phosphatidylserine externalization and macrophage engulfment: implications for the resolution of inflammation. Tyurina YY, Basova LV, Konduru NV, Tyurin VA, Potapovich AI, Cai P, Bayir H, Stoyanovsky D, Pitt BR, Shvedova AA, Fadeel B, Kagan VE. *J Biol Chem.* 2007; 282(11):8498–509.

**Abstract:** Macrophage recognition of apoptotic cells depends on externalization of phosphatidylserine (PS), which is normally maintained within the cytosolic leaflet of the plasma membrane by aminophospholipid translocase (APLT). APLT is sensitive to redox modifications of its -SH groups. Because activated macrophages produce reactive oxygen and nitrogen species, we hypothesized that macrophages can directly participate in apoptotic cell clearance by S-nitrosylation/oxidation and inhibition of APLT causing PS externalization. Here we report that exposure of target HL-60 cells to nitrosative stress inhibited APLT, induced PS externalization, and enhanced recognition and elimination of “nitrosatively” modified cells by RAW 264.7 macrophages. Using S-nitroso-L-cysteine-ethyl ester (SNCEE) and S-nitrosoglutathione (GSNO) that cause intracellular and extracellular trans-nitrosylation of proteins, respectively, we found that SNCEE (but not GSNO) caused significant S-nitrosylation/oxidation of thiols in HL-60 cells. SNCEE also strongly inhibited APLT, activated scramblase, and caused PS externalization. However, SNCEE did not induce caspase activation or nuclear condensation/fragmentation suggesting that PS externalization was dissociated from the common apoptotic pathway. Dithiothreitol reversed SNCEE-induced S-nitrosylation, APLT inhibition, and PS externalization. SNCEE but not GSNO stimulated phagocytosis of HL-60 cells. Moreover, phagocytosis of target cells by lipopolysaccharide-stimulated macrophages was significantly suppressed by an NO scavenger, DAF-2. Thus, macrophage-induced nitrosylation/oxidation plays an important role in cell clearance, and hence in the resolution of inflammation.

Interactions of cardiolipin and lyso-cardiolipins with cytochrome c and tBid: conflict or assistance in apoptosis. Tyurin VA, Tyurina YY, Osipov AN, Belikova NA, Basova LV, Kapralov AA, Bayir H, Kagan VE. *Cell Death Differ.* 2007;14(4):872–5.

**Abstract:** This is a brief communication explaining essential roles that two mitochondrial phospholipids—cardiolipin and lyso-cardiolipin—play in the execution of apoptotic program.

Cardiolipin switch in mitochondria: shutting off the reduction of cytochrome c and turning on the peroxidase activity. Basova LV, Kurnikov IV, Wang L, Ritov VB, Belikova NA, Vlasova II, Pacheco AA, Winnica DE, Peterson J, Bayir H, Waldeck DH, Kagan VE. *Biochemistry.* 2007; 46(11):3423–34.

**Abstract:** Upon interaction with anionic phospholipids, particularly mitochondria-specific cardiolipin (CL), cytochrome c (cyt c) loses its tertiary structure and its peroxidase activity dramatically increases. CL-induced peroxidase activity of cyt c has been found to be important for selective CL oxidation in cells undergoing programmed death. During apoptosis, the peroxidase activity and the fraction of



CL-bound cyt c markedly increase, suggesting that CL may act as a switch to regulate cyt c's mitochondrial functions. Using cyclic voltammetry and equilibrium redox titrations, we show that the redox potential of cyt c shifts negatively by 350–400 mV upon binding to CL-containing membranes. Consequently, functions of cyt c as an electron transporter and cyt c reduction by Complex III are strongly inhibited. Further, CL/cyt c complexes are not effective in scavenging superoxide anions and are not effectively reduced by ascorbate. Thus, both redox properties and functions of cyt c change upon interaction with CL in the mitochondrial membrane, diminishing cyt c's electron donor/acceptor role and stimulating its peroxidase activity.

Peroxidase activity and structural transitions of cytochrome c bound to cardiolipin-containing membranes. Belikova NA, Vladimirov YA, Osipov AN, Kapralov AA, Tyurin VA, Potapovich MV, Basova LV, Peterson J, Kurnikov IV, Kagan VE. *Biochemistry*. 2006; 45(15):4998–5009.

Abstract: During apoptosis, cytochrome c (cyt c) is released from intermembrane space of mitochondria into the cytosol where it triggers the caspase-dependent machinery. We discovered that cyt c plays another critical role in early apoptosis as a cardiolipin (CL)-specific oxygenase to produce CL hydroperoxides required for release of pro-apoptotic factors [Kagan, V. E., et al. (2005) *Nat. Chem. Biol.* 1, 223–232]. We quantitatively characterized the activation of peroxidase activity of cyt c by CL and hydrogen peroxide. At low ionic strength and high CL/cyt c ratios, peroxidase activity of the CL/cyt c complex was increased >50 times. This catalytic activity correlated with partial unfolding of cyt c monitored by Trp(59) fluorescence and absorbance at 695 nm (Fe-S(Met(80)) band). The peroxidase activity increase preceded the loss of protein tertiary structure. Monounsaturated tetraoleoyl-CL (TOCL) induced peroxidase activity and unfolding of cyt c more effectively than saturated tetramyristoyl-CL (TMCL). TOCL/cyt c complex was found more resistant to dissociation by high salt concentration. These findings suggest that electrostatic CL/cyt c interactions are central to the initiation of the peroxidase activity, while hydrophobic interactions are involved when cyt c's tertiary structure is lost. In the presence of CL, cyt c peroxidase activity is activated at lower H<sub>2</sub>O<sub>2</sub> concentrations than for isolated cyt c molecules. This suggests that redistribution of CL in the mitochondrial membranes combined with increased production of H<sub>2</sub>O<sub>2</sub> can switch on the peroxidase activity of cyt c and CL oxidation in mitochondria—a required step in execution of apoptosis.

Apoptotic interactions of cytochrome c: redox flirting with anionic phospholipids within and outside of mitochondria. Bayir H, Fadeel B, Palladino MJ, Witas E, Kurnikov IV, Tyurina YY, Tyurin VA, Amoscato AA, Jiang J, Kochanek PM, DeKosky ST, Greenberger JS, Shvedova AA, Kagan VE. *Biochim Biophys Acta*. 2006 May-Jun;1757(5–6):648–59.

Abstract: Since the (re)discovery of cytochrome c (cyt c) in the early 1920s and subsequent detailed characterization of its structure and function in mitochondrial electron transport, it took over 70 years to realize that cyt c plays a different, not less universal role in programmed cell death, apoptosis, by interacting with several proteins and



forming apoptosomes. Recently, two additional essential functions of cyt c in apoptosis have been discovered that are carried out via its interactions with anionic phospholipids: a mitochondria specific phospholipid, cardiolipin (CL), and plasma membrane phosphatidylserine (PS). Execution of apoptotic program in cells is accompanied by substantial and early mitochondrial production of reactive oxygen species (ROS). Because antioxidant enhancements protect cells against apoptosis, ROS production was viewed not as a meaningless side effect of mitochondrial disintegration but rather playing some-as yet unidentified-role in apoptosis. This conundrum has been resolved by establishing that mitochondria contain a pool of cyt c, which interacts with CL and acts as a CL oxygenase. The oxygenase is activated during apoptosis, utilizes generated ROS and causes selective oxidation of CL. The oxidized CL is required for the release of pro-apoptotic factors from mitochondria into the cytosol. This redox mechanism of cyt c is realized earlier than its other well-recognized functions in the formation of apoptosomes and caspase activation. In the cytosol, released cyt c interacts with another anionic phospholipid, PS, and catalyzes its oxidation in a similar oxygenase reaction. Peroxidized PS facilitates its externalization essential for the recognition and clearance of apoptotic cells by macrophages. Redox catalysis of plasma membrane PS oxidation constitutes an important redox-dependent function of cyt c in apoptosis and phagocytosis. Thus, cyt c acts as an anionic phospholipid specific oxygenase activated and required for the execution of essential stages of apoptosis. This review is focused on newly discovered redox mechanisms of complexes of cyt c with anionic phospholipids and their role in apoptotic pathways in health and disease.

Direct and indirect effects of single walled carbon nanotubes on RAW 264.7 macrophages: role of iron. Kagan VE, Tyurina YY, Tyurin VA, Konduru NV, Potapovich AI, Osipov AN, Kisin ER, Schwegler-Berry D, Mercer R, Castranova V, Shvedova AA. *Toxicol Lett.* 2006; 165(1):88–100.

Abstract: Single-walled carbon nanotubes (SWCNT), nano-cylinders with an extremely small diameter (1–2 nm) and high aspect ratio, have unique physico-chemical, electronic and mechanical properties and may exhibit unusual interactions with cells and tissues, thus necessitating studies of their toxicity and health effects. Manufactured SWCNT usually contain significant amounts of iron that may act as a catalyst of oxidative stress. Because macrophages are the primary responders to different particles that initiate and propagate inflammatory reactions and oxidative stress, we utilized two types of SWCNT: (1) iron-rich (non-purified) SWCNT (26 wt.% of iron) and (2) iron-stripped (purified) SWCNT (0.23 wt.% of iron) to study their interactions with RAW 264.7 macrophages. Ultrasonication resulted in predominantly well-dispersed and separated SWCNT strands as evidenced by scanning electron microscopy. Neither purified nor non-purified SWCNT were able to generate intracellular production of superoxide radicals or nitric oxide in RAW 264.7 macrophages as documented by flow-cytometry and fluorescence microscopy. SWCNT with different iron content displayed different redox activity in a cell-free model system as revealed by EPR-detectable formation of ascorbate radicals resulting from ascorbate oxidation. In the presence of zymosan-stimulated RAW 264.7 macrophages, non-purified iron-rich SWCNT were more effective in generating hydroxyl radicals (documented



by EPR spin-trapping with 5,5-dimethyl-1-pyrroline-N-oxide, DMPO) than purified SWCNT. Similarly, EPR spin-trapping experiments in the presence of zymosan-stimulated RAW 264.7 macrophages showed that non-purified SWCNT more effectively converted superoxide radicals generated by xanthine oxidase/xanthine into hydroxyl radicals as compared to purified SWCNT. Iron-rich SWCNT caused significant loss of intracellular low molecular weight thiols (GSH) and accumulation of lipid hydroperoxides in both zymosan- and PMA-stimulated RAW 264.7 macrophages. Catalase was able to partially protect macrophages against SWCNT induced elevation of biomarkers of oxidative stress (enhancement of lipid peroxidation and GSH depletion). Thus, the presence of iron in SWCNT may be important in determining redox-dependent responses of macrophages.

Unusual inflammatory and fibrogenic pulmonary responses to single-walled carbon nanotubes in mice. Shvedova AA, Kisin ER, Mercer R, Murray AR, Johnson VJ, Potapovich AI, Tyurina YY, Gorelik O, Arepalli S, Schwegler-Berry D, Hubbs AE, Antonini J, Evans DE, Ku BK, Ramsey D, Maynard A, Kagan VE, Castranova V, Baron P. *Am J Physiol Lung Cell Mol Physiol*. 2005; 289(5):L698–708.

Abstract: Single-walled carbon nanotubes (SWCNT) are new materials of emerging technological importance. As SWCNT are introduced into the life cycle of commercial products, their effects on human health and environment should be addressed. We demonstrated that pharyngeal aspiration of SWCNT elicited unusual pulmonary effects in C57BL/6 mice that combined a robust but acute inflammation with early onset yet progressive fibrosis and granulomas. A dose-dependent increase in the protein, LDH, and gamma-glutamyl transferase activities in bronchoalveolar lavage were found along with accumulation of 4-hydroxynonenal (oxidative biomarker) and depletion of glutathione in lungs. An early neutrophils accumulation (day 1), followed by lymphocyte (day 3) and macrophage (day 7) influx, was accompanied by early elevation of proinflammatory cytokines (TNF-alpha, IL-1beta; day 1) followed by fibrogenic transforming growth factor (TGF)-beta1 (peaked on day 7). A rapid progressive fibrosis found in mice exhibited two distinct morphologies: 1) SWCNT-induced granulomas mainly associated with hypertrophied epithelial cells surrounding SWCNT aggregates and 2) diffuse interstitial fibrosis and alveolar wall thickening likely associated with dispersed SWCNT. *In vitro* exposure of murine RAW 264.7 macrophages to SWCNT triggered TGF-beta1 production similarly to zymosan but generated less TNF-alpha and IL-1beta. SWCNT did not cause superoxide or NO production, active SWCNT engulfment, or apoptosis in RAW 264.7 macrophages. Functional respiratory deficiencies and decreased bacterial clearance (*Listeria monocytogenes*) were found in mice treated with SWCNT. Equal doses of ultrafine carbon black particles or fine crystalline silica (SiO<sub>2</sub>) did not induce granulomas or alveolar wall thickening and caused a significantly weaker pulmonary inflammation and damage.

Cytochrome c acts as a cardiolipin oxygenase required for release of proapoptotic factors. Kagan VE, Tyurin VA, Jiang J, Tyurina YY, Ritov VB, Amoscato AA, Osipov AN, Belikova NA, Kapralov AA, Kini V, Vlasova II, Zhao Q, Zou M, Di P, Svistunenko DA, Kurnikov IV, Borisenko GG. *Nat Chem Biol*. 2005;1(4):223–32.



**Abstract:** Programmed death (apoptosis) is turned on in damaged or unwanted cells to secure their clean and safe self-elimination. The initial apoptotic events are coordinated in mitochondria, whereby several proapoptotic factors, including cytochrome c, are released into the cytosol to trigger caspase cascades. The release mechanisms include interactions of B-cell/lymphoma 2 family proteins with a mitochondria-specific phospholipid, cardiolipin, to cause permeabilization of the outer mitochondrial membrane. Using oxidative lipidomics, we showed that cardiolipin is the only phospholipid in mitochondria that undergoes early oxidation during apoptosis. The oxidation is catalyzed by a cardiolipin-specific peroxidase activity of cardiolipin-bound cytochrome c. In a previously undescribed step in apoptosis, we showed that oxidized cardiolipin is required for the release of proapoptotic factors. These results provide insight into the role of reactive oxygen species in triggering the cell-death pathway and describe an early role for cytochrome c before caspase activation.

Nanomedicine and nanotoxicology: two sides of the same coin. Kagan VE, Bayir H, Shvedova AA. *Nanomedicine*. 2005;1(4):313–6.

**Abstract:** Current advances in nanotechnology have led to the development of the new field of nanomedicine, which includes many applications of nanomaterials and nanodevices for diagnostic and therapeutic purposes. The same unique physical and chemical properties that make nanomaterials so attractive may be associated with their potentially calamitous effects on cells and tissues. Our recent study demonstrated that aspiration of single-walled carbon nanotubes elicited an unusual inflammatory response in the lungs of exposed mice with a very early switch from the acute inflammatory phase to fibrogenic events resulting in pulmonary deposition of collagen and elastin. This was accompanied by a characteristic change in the production and release of proinflammatory to anti-inflammatory profibrogenic cytokines, decline in pulmonary function, and enhanced susceptibility to infection. Chemically unmodified (nonfunctionalized) carbon nanotubes are not effectively recognized by macrophages. Functionalization of nanotubes results in their increased recognition by macrophages and is thus used for the delivery of nanoparticles to macrophages and other immune cells to improve the quality of diagnostic and imaging techniques as well as for enhancement of the therapeutic effectiveness of drugs. These observations on differences in recognition of nanoparticles by macrophages have important implications in the relationship between the potentially toxic health effects of nanomaterials and their applications in the field of nanomedicine.

### **O'SHAUGHNESSY 8806 (R01) Assessment Methods for Nanoparticles in the Workplace**

#### ***Final Report Abstract:***

The aims of this research were to: Identify and evaluate methods to measure airborne nanoparticle concentrations; characterize nanoparticles using a complementary suite of techniques to assess their surface and bulk physical and chemical properties; and determine the collection efficiency of commonly-used respirator filters when



challenged with nanoparticles. Aim 1 findings have led to practical proposals for the use of instrumentation by industrial hygienists when evaluating a workplace for the presence, and amount, of nanoparticle aerosols. Our laboratory findings have led to a method for using two hand-held instruments to reproduce the size distribution of an aerosol from the sub-micrometer to micrometer range in order to obtain an understanding of the nanoparticle count and distribution. This is significant because the only alternative methods require very expensive, bench-top instruments. Our field component of Aim I led to the development of a method which utilizes the same two hand-held instruments, in conjunction with transmission electron microscopy, to also physically and chemically characterize the nanoparticles counter; therefore, their potential source can be identified. Aim 2 findings centered on the best of use of sophisticated analytical instruments to best determine the nature of a nanopowder from a bulk sample. A suite of surface and bulk powder analytical techniques was found to provide the most information including. The findings obtained from these analyses allowed us to distinguish specific characteristics of the nanopowders used from the many possible for each powder type. This result was especially apparent when analyzing carbon nanotubes which can have a wide variety, and concentration, of contaminant compounds that can potentially change its physical properties and toxicological effects. Work associated with Aim 3 involved testing two respirator filter types, and N95 and P100, when challenged with a variety of nanoparticle types. In general, the filters performed within their expected efficiency requirements except when challenged with carbon nanotubes.

The principle aspect of our research that can be translated into practice is the development and assessment of a nanoparticle exposure methodology that can be employed by industrial hygienists in the field. This method utilizes field-capable instruments to both enumerate nanoparticles and characterize their morphology and elemental composition. Given that the instruments associated with this method are currently available, the method can be presently utilized by industrial hygienists. The relevance of this work is related to the current need for a method to assess workplaces for nanoparticle exposures. The field of nanotechnology, and the related development of nanopowders in particular, has advanced more rapidly than the steps needed to offer guidance to these industries in terms of both threshold limit values (TLVs) and proper assessment methods. Both the TLVs and related assessment methods for most occupational dust types are based on a mass measurement. These are clearly inadequate when dealing with particles in the submicrometer range, which necessarily constitute a very low percentage of the total mass of an aerosol (given a wide distribution) or are undetectable on a mass-basis (given a narrow distribution). The results from this study will aid in the important work needed to develop both TLVs and associated sampling methods for nanoparticle exposures.

### ***Recent Publications***

O'Shaughnessy PT. (2008) Occupational Health Hazards of Nanoparticles. In: Nanoscience and Nanotechnology: Environmental and Health Impacts. VH Grassian Ed. New York: John Wiley & Sons.

Pettibone J, Elzey S, Grassian VH. (2008) An integrated Approach Toward Understanding the Environmental Fate, Transport, Toxicity and Health Hazards of Nanomaterials. In: Nanoscience and Nanotechnology: Environmental and Health Impacts. VH Grassian Ed. New York: John Wiley & Sons.

Peters, Thomas M., Elzey, Sherrie, Johnson, Ronald, Park, Heaweon, Grassian, Vicki H, Maher, Tabitha and O'Shaughnessy, Patrick (2009). Airborne Monitoring to Distinguish Engineered Nanomaterials from Incidental Particles for Environmental Health and Safety. *Journal of Occupational and Environmental Hygiene*, 6:2,73–81.

**Abstract:** Two methods were used to distinguish airborne engineered nanomaterials from other airborne particles in a facility that produces nano-structured lithium titanate metal oxide powder. The first method involved off-line analysis of filter samples collected with conventional respirable samplers at each of seven locations (six near production processes and one outdoors). Throughout most of the facility and outdoors, respirable mass concentrations were low ( $<0.050 \text{ mg/m}^3$ ) and were attributed to particles other than the nanomaterial ( $<10\%$  by mass titanium determined with inductively coupled plasma atomic emission spectrometry). In contrast, in a single area with extensive material handling, mass concentrations were greatest ( $0.118 \text{ mg/m}^3$ ) and contained up to  $39\% \pm 11\%$  lithium titanium, indicating the presence of airborne nanomaterial. Analysis of the filter samples collected in this area by transmission electron microscope and scanning electron microscope revealed that the airborne nanomaterial was associated only with spherical aggregates (clusters of fused 10–80 nm nanoparticles) that were larger than 200nm. This analysis also showed that nanoparticles in this area were the smallest particles of a larger distribution of submicrometer chain agglomerates likely from welding in an adjacent area of the facility. The second method used two, hand-held, direct-reading, battery-operated instruments to obtain a time series of very fine particle number ( $<300\text{nm}$ ), respirable mass, and total mass concentration, which were then related to activities within the area of extensive material handling. This activity-based monitoring showed that very fine particle number concentrations ( $<300 \text{ nm}$ ) had no apparent correlation to worker activities, but that sharp peaks in the respirable and total mass concentration coincided with loading a hopper and replacing nanomaterial collection bags. These findings were consistent with those from the filter-based method in that they demonstrate that airborne nanoparticles in this facility are dominated by “incidental” sources (e.g., welding or grinding), and that the airborne “engineered” product is predominately composed of particles larger than several hundred nanometers. The methods presented here are applicable to any occupational or environmental setting in which one needs to distinguish incidental sources from engineered product.

## **XIONG 8807 (R01) Monitoring and Characterizing Airborne Carbon Nanotube Particles**

### **Background**

The proposed research will develop a comprehensive, yet practical, method for sampling, quantification and characterization of carbon nanotube (CNT) particles in



air. This method will be capable of classifying sampled particles into three categories: tubes, ropes (bundles of single-walled CNTs bounded by Van der Waals attraction force), and non-tubular particles (soot, metal catalysts, and dust, etc.), and measuring the number concentrations and size distributions for each type, and the shape characters (diameter, length, aspect ratio and curvature) of CNTs.

The method will utilize available instrumentation to build an air monitoring system that is capable of sampling and sizing airborne CNT particles in a wide size range by using a 10-stage Micro-orifice uniform Deposit Impactor (MOUDI) and an Integrated Diffusion Battery previously developed in this laboratory.

Successful completion of this project will produce a validated method for sampling airborne CNTs in workplaces; and a practical method using Atomic Force Microscopy image analysis technology to classify sampled CNT particles by type, and quantifying and characterizing each type separately. These methods are needed to determine potential health risks that may result from worker exposure to the various types: CNTs, nanoropes, and non-tubular nanoparticles. The results will also provide a foundation for field and personal sampling devices for CNTs.

#### **THOMPSON 8739 (R43) Antistatic Paint with Silent Discharge**

For the variety of organizations that process, store, and handle flammable materials, static electricity can present a serious danger. This is demonstrated when a static discharge releases more energy than the minimum ignition energy of the flammable material in the presence of the right oxidation source (i.e., air). This leads to ignition of the material and under the right pressure constraints can lead to a violent explosion. Statistics from the National Fire Prevention Association show that, on average, static electricity is implicated in 280 structure fires reported to US fire departments annually.<sup>7</sup> These organizations can include fuel refineries, service stations, and coal mining operations that handle volatile chemicals. In addition, facilities that generate fine particulates whose increased surface area enhances their flammability such as grain elevators, mining operations, food processing, or sawmills are also in peril from static discharge. Aside from the millions of dollars in lost property, ESD-initiated fires and explosions have been implicated in numerous injuries and fatalities.

Proposed is the development of paint that relies on an alternative grounding mechanism. Nano-sized “emitter” particles will be added to the paint that will expose nano-sized ridges and tips. Because charge is proportional to area, in the nano-region around the particle tips, there will be a tremendous buildup of charge leading to nano-voltages that are well above the breakdown voltage of air. Consequently, the charge would leak off in corona discharges until safe voltage is reached. Because the points where these events take place is so small, the regional voltage and charge density will stay at “safe” levels.

#### **DEININGER 8939 (R43) New Nanostructured Sensor Arrays for Hydride Detection**

DESCRIPTION (provided by applicant): Development of improved detectors for the detection of hydrides (including arsine, phosphine and diborane) will provide an

increase in the protection of worker health and safety. This Phase II proposal aims to develop and demonstrate a prototype gas detection system capable of affordably and reliably detecting toxic gases at low ppb levels. Drawing upon advances in nanotechnology, micromachining and materials chemistry, the Phase I proposal demonstrated the feasibility of creating electronic sensors that are substantially better than current state of the art for hydrides detection. These improved sensors will be the basis for improved personal and permanent monitors for increased protection of workers in the semiconductor industry and other applications. Furthermore, the development of these highly innovative, sensitive and selective sensors will lay the groundwork for the development of additional sensors for detecting a wide range of chemical hazards that exist in the workplace today. Public Health Relevance: Hydrides are dangerous gases that are widely used in the semiconductor and other industries. The proposed project will develop advanced sensors that can be used in personal protective devices to warn users about the presence of these highly toxic gases.

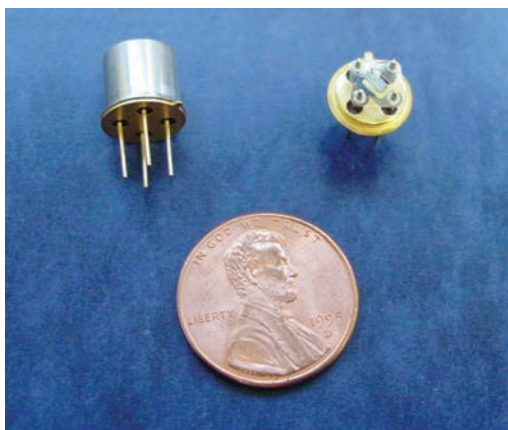

Synkera's Hydride Microsensor

### **DUTTA 9141 (R01) Role of Surface Chemistry in the Toxicological Properties of Manufactured Nanoparticles**

#### **Background**

The objectives of this program are to verify two hypotheses. First, the quantifiable differences in surface reactivity of nanoparticles, as measured by acidity, redox chemistry, metal ion binding and Fenton chemistry as compared to micron-sized particles of similar composition cannot be explained by the increase in surface area alone. Second, the oxidative stress and inflammatory response induced by nanoparticles upon interaction with macrophages and epithelial cells is dependent on their surface reactivity. The basis of these hypotheses is that nanoparticles contain significantly higher number of “broken” bonds on the surface that provide different reactivity as compared to larger particles.

The experimental approach focuses on three classes of manufactured nanoparticles, catalysts (aluminosilicates), titania and carbon. For the catalysts and titania samples,



nanoparticles (< 100 nm) and micron-sized particles of similar bulk composition will be studied. For carbon, carbon black and single walled carbon nanotubes are chosen. Nanoparticles of aluminosilicates and titania will be synthesized, whereas the other particles will be obtained from commercial sources. Characterization will involve electron microscopy, surface area, surface and bulk composition.

Reactivity of well-characterized particles in regards to their acidity, reaction with antioxidants simulating the lung lining fluid, coordination of iron and Fenton chemistry will be carried out using spectroscopic methods. Particular attention will be paid to surface activation as may exist during manufacturing and processing. In-vitro oxidative stress and inflammatory responses upon phagocytosis of the particles by macrophages and pulmonary epithelial cells will form the toxicological/biological endpoints of the study. Methods include gene array techniques, assays for reactive oxygen species and adhesion molecules on endothelial cells.

#### **TIMCHALK 8173(R01) Non-Invasive Biomonitoring of Pesticides**

This research project will establish a non-invasive biomonitoring capability to evaluate exposure to organophosphorus (OP) insecticides utilizing a sensitive, non-invasive, micro-analytical instrument for realtime analysis of biomarkers of exposure and response in saliva. This project will create a miniaturized nanobioelectronic biosensor that is highly selective and sensitive for the target analyte(s). In addition, a physiologically based pharmacokinetic and pharmacodynamic model (PBPK/PD) for the OP insecticide chlorpyrifos will be modified to incorporate a salivary gland compartment that will be used to quantitatively predict blood chlorpyrifos concentration and saliva cholinesterase (ChE) inhibition to estimate exposure based on a saliva specimen. The utilization of saliva for biomonitoring, coupled to real-time monitoring and modeling is a novel approach with broad application for evaluating occupational exposures to insecticides. An OP sensor will be developed based on a new biosensing principle of antigen-induced formation of nanoparticle-immuno complex nanostructure. A ChE sensor will also be developed based on the electro detection of the ChE hydrolyzed reaction products choline and hydrogen peroxide. Subsequently, the sensors will be transformed to a “lab-on-a-chip”, and the biochip performance will be characterized, optimized and validated. To validate this approach the pharmacokinetics of chlorpyrifos excretion and ChE inhibition in saliva under various physiological conditions and dose levels will be assessed to ensure that these endpoints are accurate predictors of internal dose. The development of a real-time saliva analysis coupled to a predictive pharmacokinetic model represents a significant advancement over current biomonitoring strategies. Once this model system has been adequately validated it can readily be employed to assess worker exposure to insecticides under a wide range of occupational situations.

#### **Executive Highlight**

In articulating a vision for Toxicity Testing in the 21st Century, the National Research Council (NRC) noted that exposure science will play a critical role in a new risk-based



framework. In this context, biomonitoring is a key component that quantitatively associates an internal dose with a measurable effect. It has also been suggested that epidemiology studies which accurately assess chemical exposures along with biological effects will have the most meaningful interpretation and thus maximal impact. However, a major impediment in conducting quantitative biomonitoring within epidemiology studies is the lack of rapid, field deployable, quantitative technologies that measure chemical exposure/response biomarkers using minimally invasive biological fluids (i.e. saliva). Due to the complex nature of environmental exposures and biological systems, measurement of a single biomarker may not provide adequate quantitative assessment of exposure. Hence, this project has undertaken development, validation, and refinement of novel sensor platforms capable of quantifying multiple biomarkers associated with pesticide exposures (dose), utilizing saliva as a readily obtainable biological fluid. In addition, pharmacokinetic evaluations have been exploited to facilitate quantifying dosimetry. Our ongoing research has focused on the development of a number of organophosphorus specific pesticide sensor platforms. These include a quantum dot-based immunochromatographic fluorescent biosensor for quantifying the chlorpyrifos metabolite trichloropyridinol (TCPy), and a carbon nanotube-enhanced flow-injection amperometric detection system for quantifying cholinesterase activity. This technology innovation makes the proposed multiplex sensor strategy substantially more compelling for use in detecting anticipated low level biomarker concentrations. A key focus of the current project has been to develop and validate the sensors in experimental animal (*in vitro* & *in vivo*) and human (*in vitro*) systems. This novel platform will enable a more accurate prediction of exposures and once validated, can readily be employed to assess dosimetry to pesticides in support of biomonitoring and epidemiology studies.

**Peer-reviewed publications (credited to this project).**

1. Timchalk, C., Campbell, J. A., Liu, G., Lin, Y. and Kousba, A. A. (2007). Development of a non-invasive biomonitoring approach to determine exposure to the organophosphorus insecticide chlorpyrifos in saliva of rats. *Toxicol. Appl. Pharmacol.*, 219: 217–225, PMID: 17118418.
2. Timchalk, C., Busby, A., Campbell, J. A., Needham, L. L., and Barr, D. B. (2007). Comparative pharmacokinetics of the organophosphorus insecticide chlorpyrifos and its major metabolites diethylphosphate, diethylthiophosphate and 3,5,6-trichloro-2-pyridinol in the rat. *Toxicol.*, 237: 145–157, PMID: 17590257.
3. Timchalk, C., Kousba, A. A., and Poet, T. S. (2007). An age-dependent physiologically based pharmacokinetic/pharmacodynamic model for the organophosphorus insecticide chlorpyrifos in the preweanling rat. *Toxicol. Sci.*, 98(2): 348–365, PMID: 17504771.
4. Marty, M. S., Domoradzki, J. Y., Hansen, S. C., Timchalk, C., Bartels, M. J., Mattsson, J. L. (2007). The effect of route, vehicle, and divided doses on the pharmacokinetics of chlorpyrifos and its metabolite trichloropyridinol





- in neonatal Sprague-Dawley rats. *Toxicol. Sci.*, 100(2): 360–373, PMID: 17928393.
5. Liu G, and Y Lin. (2007). Nanomaterial Labels in Electrochemical Immunosensors and Immunoassays. *Talanta* 74(3): 308–317.
  6. Liu G, YY Lin, J Wang, H Wu, CM Wai, and Y Lin. (2007). Disposable Electrochemical Immunosensor Diagnosis Device Based on Nanoparticle Probe and Immunochromatographic Strip. *Analytical Chemistry* 79(20): 7644–7653
  7. Timchalk, C. and Poet, T. S. (2008) Development of a physiologically based pharmacokinetic and pharmacodynamic model to determine dosimetry and cholinesterase inhibition for a binary mixture of chlorpyrifos and diazinon in the rat. *NeuroTox.* 29: 428–443.
  8. Wang, J., Timchalk, C., and Lin, Y. (2008) Carbon nanotube-based electrochemical sensor for assay of salivary cholinesterase enzyme activity: an exposure biomarker of organophosphate pesticides and nerve agents. *Environ. Sci. Tech.* 42(7): 2688–2693.
  9. Liu G, J Wang, RC Barry, CE Petersen, C Timchalk, PL Gassman, and Y Lin. (2008). Nanoparticle-Based Electrochemical Immunosensor for Detection of Phosphorylated Acetylcholinesterase Adduct: An Exposure Biomarker of Organophosphate Pesticides and Nerve Agents. *Chemistry-a European Journal* 14(32): 9951–9959.
  10. Wang J, and Y Lin. (2008). Functionalized carbon nanotubes and nanofibers for biosensing applications. *Trends in Analytical Chemistry.* 27(7): 619–626.
  11. Wang H, J Wang, C Timchalk, and Y Lin. (2008). Magnetic Electrochemical Immunoassays with Quantum Dot Labels for Detection of Phosphorylated Acetylcholinesterase in Plasma. *Analytical Chemistry* 80(22): 8477–8484.
  12. Du, D., Wang, J., Smith, J. N., Timchalk, C. and Lin, Y. (2009). Biomonitoring of organophosphorus pesticide inhibition by reactivation of saliva cholinesterase enzyme based on carbon nanotube-enhanced flow-injection amperometric detection. *Anal. Chem.* 81: 9341–9320 PMID: 19839597.
  13. Smith, J. N., Campbell, J. A., Busby, A. L., Lee, S., Poet, T. S., Barr, D. B. and Timchalk, C. (2009). Comparative chlorpyrifos pharmacokinetics via multiple routes of exposure and vehicles of administration in the adult rat. *Toxicol.* 261: 47–58 PMID: 19397948.
  14. Lowe, E. R., Poet, T. S., Rick, D. L., Marty, M. S., Mattson, J. L., Timchalk C., and Bartels, M. J. (2009). The effect of lipid changes on the tissue partitioning of chlorpyrifos and the impact on perinatal dosimetry using a late gestational PBPK/PD model. *Toxicol. Sci.*, 108(2): 258–272 PMID: 19223661.

15. Lee, S., Busby, A. L., Timchalk, C. and Poet, T. S. (2009). Effects of nicotine exposure on *in vitro* CYP450-mediated metabolism of chlorpyrifos in Sprague-Dawley male rats. *J. Toxicol. Environ. Health A.*, 72: 74–82 PMID: 19034796.
16. Barry, R. C., Lin, Y., Wang, J., Liu, G., and Timchalk, C. (2009). Nanotechnology-based electrochemical sensors for biomonitoring chemical exposures. *J. Exp. Sci. and Environ. Epidemiol.* 19(1): 1-18 Invited Review PMID: 19018275.
17. Garabrant, D. H., Aylward, L. L., Berent, S., Chen, Q., Timchalk, C., Burns, C. J., Hays, S. M., and Albers, J. W. (2009). Cholinesterase inhibition in chlorpyrifos workers: characterization of biomarkers of exposure and response in relation to urinary TCP. *J. Exp. Sci. and Environ. Epidemiol.* 19: 634–642 PMID: 18716607.
18. Lee, S., Poet, T. S., Smith, J. N., Busby-Hjerpe, A. L. and Timchalk C. (2010). Effects of *in vivo* nicotine exposure on chlorpyrifos pharmacokinetics and pharmacodynamics in the rat. *Chemico-Biological Interaction.* 184 (3): 449-457 PMID: 20097188.
19. Smith, J. N., Wang, J., Lin, Y. and Timchalk, C. (2010). Pharmacokinetics of the chlorpyrifos metabolite 3,5,6-trichloro-2-pyridinol (TCPy) in rat saliva. *Toxicol. Sci.*, 113(2): 315-32 PMID: 19920072.
20. Hjerpe-Busby, A. L., Campbell, J. A., Smith, J. N., Lee, S., Poet, T. S., Barr, D. B. and Timchalk, C. (2010). Comparative pharmacokinetics of chlorpyrifos versus its major metabolites following oral administration in the rat. *Toxicol.* 268 (1-2): 55-63 PMID: 19963030.

**Book Chapters & Non-Peer Reviewed Presentation (credited to this project):**

1. Wang J, G Liu, and Y Lin (2007). Nanotubes, Nanowires, and Nanocantilevers in Biosensor Development. Chapter 3 In: *Nanomaterials for Biosensors, Nanotechnologies for Life Sciences*, vol. 8, ed. Challa S.S.R. Kumar, pp. 56–100. Wiley-VCH, Weinheim, Germany.
2. Poet, T. S. and Timchalk, C. (2008). PBPK/PD model simulations of the effects of changes in enzyme levels on plasma esterase inhibition and urinary TCPy elimination following chlorpyrifos exposure. Public Comments (EPA-HQ-OPP-2008-0274-0002.1), EPA, FIFRA Science Advisory Panel.
3. Lin, Y., Wang, J. and Timchalk C. (2009). Portable Analytical Systems for On-Site Diagnosis of Exposure to Pesticides and Nerve Agents. In: *Nanoscience and Nanotechnology for Chemical and Biological Defense*, Invited Book Chapter ACS Symposium Series.
4. Timchalk, C. (2010) Organophosphorus insecticide pharmacokinetics, Chapter 66 In: *Hayes' Handbook of Pesticide Toxicology*, Third Edition, (Ed. R. Krieger), Academic Press, San Diego, CA.



5. Timchalk, C. (2010). Biomonitoring of pesticides: pharmacokinetics of organophosphorus and carbamate insecticides. In: *Anticholinesterase pesticides: metabolism, neurotoxicity and epidemiology*. (eds. T. Satoh and R. C. Gupta), John Wiley (In Press).
6. Timchalk, C., Hinderliter P. M. and Poet, T. S. (2010). Cholinesterase Inhibition. In: *Quantitative Modeling in Toxicology*. (Eds. M. Andersen and K. Krishnan). John Wiley, West Sussex, UK., pp. 137–165.

**Presentations (credited to this project):**

1. Timchalk, C., Kousba, A, Busby, A. and Poet, T. (2007). Development of physiologically based pharmacokinetic and pharmacodynamic (PBPK/PD) models to determine dosimetry and cholinesterase inhibition following exposure to binary mixtures of organophosphorus insecticides. (Invited Symposium), *ToxSci (Toxicologist)*, 96(1): 1324.
2. Liu, G., Lin, Y., Campbell, J. A and Timchalk, C. (2007). Development of a magnetic immunosensor to biomonitor for the chlorpyrifos metabolite trichloropyridinol. *Tox Sci (Toxicologist)*, 96(1): 414.
3. Lin, Y., Liu, G., Wang, J., Timchalk, C., Gassman, P. L., Barry, R. C., Busby, A. L. and Wang, H. (2008). Nanoparticle-based electrochemical immunosensor for detection of phosphorylated acetylcholinesterase adduct: an exposure biomarker of organophosphate pesticides and nerve agents. SOT Annual Meeting, March 16–20th, Seattle WA.
4. Liu, G., Riechers, S. L., Timchalk, C., and Lin, Y. (2008). Quantum-dots-based electrochemical immunoassay for the chlorpyrifos and trichloropyr metabolite trichloropyridinol. SOT Annual Meeting, March 16–20th, Seattle WA.
5. Timchalk, C., Busby, A. L., and Poet, T. S. (2008). PBPK modeling of the major chlorpyrifos metabolite trichloropyridinol: a potential biomonitoring strategy. SOT Annual Meeting, March 16–20th, Seattle WA.
6. Wang, L., Liu, G., Timchalk, C., and Lin, Y. (2008). Carbon nanotube-based electrochemical sensor for cholinesterase enzyme activity: an organophosphorus insecticide and nerve agent exposure monitor. SOT Annual Meeting, March 16–20th, Seattle WA.
7. Wang, J., Lin, Y., Campbell, J. A., and Timchalk, C. Nanoparticle label-based immunosensor for biomonitoring of trichloropyridinol. 47th Annual Meeting of SOT, Seattle, WA. March 17–19, 2008.
8. Lin, Y., Wang, J., Liu, G. D., Timchalk, C., Nanoparticle-based electrochemical immunosensor for detection of phosphorylated acetylcholinesterase adduct: an exposure biomarker of organophosphate pesticides and nerve agents. 47th Annual Meeting of SOT, Seattle, WA. March 17–19, 2008.

9. Poet, T. S., Campbell, J. A., Busby, A. L. and Timchalk, C. (2008). PBPK/PD modeling of chlorpyrifos in sensitive populations: Implications for biomonitoring of exposure. NIOSH, Health and Safety in Western Agriculture Conference, Nov 11–13th, Cle Elum, WA.
10. Smith, J. N., Poet, T. S., Campbell, J. A. and Timchalk, C. (2008). Pharmacokinetics of chlorpyrifos metabolites in saliva. NIOSH, Health and Safety in Western Agriculture Conference, Nov 11–13th, Cle Elum, WA.
11. Timchalk, C. (2008). Nanotechnology-based electrochemical sensors for biomonitoring chemical exposure. CDC/NIOSH, Direct-Reading Exposure Assessment Methods (DREAM Workshop). Nov. 13–14th, Washington, DC. (Invited Speaker).
12. Fox RM, Smith JN, Busby AL, and Timchalk C. (2008). Effects of chlorpyrifos and chlorpyrifos-oxon on cholinesterase in lungs of the rat. Micro Nano Breakthrough Conference (Vancouver, WA, USA).
13. Smith JN, Wang J, Lin Y, Campbell JA, Timchalk C. (2008). Development of Non-invasive Sensors to Detect Pesticides in Saliva. Center for Disease Control/ National Institute for Occupational Safety and Health (CDC/NIOSH) National Occupational Research Agenda Symposium (NORA) (Denver, CO, USA).
14. Busby AL, Smith JN, Campbell JA, Timchalk C, Poet TS, Needham LL, Barr D. (2008). Use of C-13 Labeled Chlorpyrifos to Quantify Oral Bioavailability in the Rat. American Society for Mass Spectrometry Conference (ASMS) (Denver, CO, USA).
15. Timchalk, C., Fox, R. M., Meyer, K. M., Lee, S., Smith, J. N., Busby, A. L. and Poet, T. S. (2009). Metabolism and cholinesterase inhibition in lungs of rats following *in vitro* chlorpyrifos exposure. Society of Toxicology Annual Meeting, March, Baltimore MD.
16. Smith, J. N., Campbell, J. A., Busby, A. L., Poet, T. S., Barr, D. B. and Timchalk, C. (2009). Comparative chlorpyrifos pharmacokinetics via multiple routes of exposure and vehicles of administration. Society of Toxicology Annual Meeting, March, Baltimore MD.
17. Klohe, E. M., Smith, J. N., Lee, S., and Timchalk, C. (2010). Characterization and normalization of cholinesterase activity in rat saliva. Society of Toxicology Annual Meeting, March 7–11th, Salt Lake City, UT.
18. Timchalk, C., Campbell, J. A., Busby, A. L., Smith, J. N., Lee, S., Poet, T. S., and Barr, D. B. (2010). Comparative pharmacokinetics of chlorpyrifos versus its major metabolites following oral administration in the rat. Society of Toxicology Annual Meeting, March 7–11th, Salt Lake City, UT.



19. Smith, J. N., Wang, J. Lin, Y., Timchalk, C. (2010). Pharmacokinetics of 3,5,6-trichloro-2-pyridinol (TCPy), a chlorpyrifos metabolite, in rat saliva. Society of Toxicology Annual Meeting, March 7–11th, Salt Lake City, UT.
20. Du, D., Wang, J., Timchalk, C. and Lin, Y. (2009). Carbon nanotube-based electrochemical sensor for assay of saliva cholinesterase enzyme activity: an exposure biomarker of organophosphorus pesticides. American Chemical Society 64th Northwest Regional Meeting (NORM 2009), June 30th, Tacoma, WA.
21. Zhang, U., Lin, C. T., Wang, J., Hong, W., Pinwatana, K., Tang, Z., Timchalk, C. and Lin, Y. (2009). Immunoassays of phosphorylated cholinesterase as biomarkers for rapid diagnosis of exposure to organophosphorus agents. American Chemical Society 64th Northwest Regional Meeting (NORM 2009), June 30th, Tacoma, WA.

#### **VOLCKENS 9114 (R21) A High-Flow Personal Sampler for Inhalable Aerosol**

While occupational respiratory diseases inflict a severe toll on our national workforce, existing exposure assessment methods for many respiratory hazards lack sufficient detection sensitivity, preventing the practicing industrial hygienist from determining whether a hazard even exists. The goal of this research is to design a high flow sampling device engineered to assess inhalable aerosol hazards in the workplace in a physiologically relevant fashion. This device will extend overall method detection limits by considerably increasing sampler flow rate. The design will be inexpensive and readily-integrated into the commonly used 37-mm filter cassette. Because of its low cost, accuracy, ease-of-use, and adaptability, this device will have widespread application, especially in developing countries where exposure assessment resources and budgets are limited. Such widespread use was a major design goal for this technology, as increased use of an accurate exposure assessment technology will ultimately result in increased protection of worker health on a national and global scale. There are 3 specific aims for this project. First, to design an inexpensive, modular sampling head that (a) interfaces with a standard 37-mm cassette, (b) operates at a high rate of airflow, 10 Lpm, and (c) meets the criteria for inhalable sampling set by the American Conference of Governmental Industrial Hygienists/International Standards Organization. This high-flow design will proceed from a wide body of research on existing low-flow inhalable devices. Second, to evaluate sampler performance using computational fluid dynamic modeling and to refine the prototype design based on results from these tests. Third, to validate the refined design through laboratory tests in a wind tunnel and field tests in actual occupational environments.

#### **PETERS 9255 (K01) Personal Exposure Monitoring to Engineered Nanoparticles**

##### ***Final Report Abstract:***

Worldwide production of engineered nanoparticles is expected to grow from 2,000 metric tons to 50,000 metric tons over the next decade. New industrial processes must be introduced into the workplace to accommodate this growth. Although studies

have shown some nanoparticles to be toxic, methods to assess exposure do not exist. However, knowledge of personal exposure may be particularly important for such small particles because their concentration tends to decay rapidly with distance from a source. The immediate objective of this K01 Career Development Award was to allow Dr. Thomas Peters to make a successful transition to an independent investigator in the field of occupational and environmental health, with emphasis on protecting the health of workers from exposure to aerosols.

In the research component of this Award, laboratory studies were conducted under Aim 1 to develop and evaluate methods to assess personal exposure to nanoparticles. We developed a method to assess rapid fluctuations in nanoparticle concentrations with direct-read instruments and a filter-based method to quantitatively collect nanoparticles for subsequent analysis by electron microscopy. Under Aim 2 field studies, we used these methods to investigate the extent to which workers are exposed to engineered nanoparticles in facilities that produce and handle them. We found that workplace exposure to engineered nanomaterials can be highly variable by worker, by activity and/or by area of a facility. Handling nanomaterials was found to be associated with particles that were respirable but not nano-sized. Further, incidental nanoparticles were generated by hot processes and unrelated to nanomaterial handling. Samples of particles collected from workplaces were analyzed by electron microscopy with energy dispersive X-ray detection under Aim 3. These analyses allowed us to classify particles within the workplace by size, composition, and morphology. These data are critical in evaluating hazards of working with nanomaterials and controlling sources.

Our field measurements have shown the inherent complexity of assessing nanoparticles in the workplace. We have identified new processes required to produce and handle engineered nanomaterials that pose a significant challenge to environmental health and safety. These processes represent a small number of many that will be required in the burgeoning field of nanotechnology. We have shown that substantial exposures to nanoparticles may occur in environments where respirable mass concentrations are low. Consequently, the industrial hygiene sampling paradigm of comparing mass measurements with mass-based OELs has severe limitations when applied to engineered nanomaterials.

This research component was complemented by a vigorous career development plan, which included: (1) formal training in; (2) regular meetings with the sponsors of this award; (3) participation in group meetings and departmental seminars; (4) presenting results at scientific meetings; and (5) publishing results in peer-reviewed journals. The multidisciplinary team of sponsors has played an active and critical role in both the research and career development components of this K01 Award.

### **GRASSIAN 9448 (R01) An Integrated Approach Toward Understanding the Toxicity of Inhaled Nanomaterials**

Manufactured nanomaterials are found in cosmetics, lotions, coatings, and used in environmental remediation applications. There exists a large opportunity for exposure through many different routes making it necessary to study the health implications





of these materials. The primary objective of this research is to fully integrate studies of the physical and chemical properties of commercially manufactured nanoparticles with inhalation toxicological studies of these same nanoparticles to determine those properties that most significantly affect nanoparticle toxicity. Our central hypothesis is that nanoparticle physico-chemical properties differ widely among particle types and certain properties induce adverse health outcomes. Furthermore, we hypothesize that nanoparticle toxicity is influenced by the susceptibility of the individual as well as the presence of other inflammatory substances. We will address these hypotheses through a series of specific study aims designed to establish a relationship between nanoparticle physicochemical properties and health outcomes.

**Specific Aim 1:** Evaluate nanoparticle chemical composition (bulk and surface) on nanoparticle toxicity in acute and sub-acute exposure studies. Experiments will be designed to investigate nanoparticle composition (bulk and surface) before, during and after inhalation exposure studies.

**Specific Aim 2:** Determine the impact of nanoparticle physical morphology (agglomeration size, agglomeration state and nanoparticle shape) on nanoparticle toxicity. This study will incorporate animal inhalation studies to determine the relationship between nanoparticle agglomerate size and nanoparticle shape on toxicity.

**Specific Aim 3:** Determine if pulmonary clearance is impaired by inhaled nanoparticles and if impaired clearance increases the risk of pulmonary infection. The pulmonary clearance mechanism, especially the ability of alveolar macrophages to clear microbes or foreign particles, can be impaired by inhaled particulates. We will compare lung clearance rates after inhalation of nanoparticles of different composition.

**Specific Aim 4:** Compare lung inflammation produced by co-exposure of nanoparticles with other inflammatory substances and relative to the nanoparticles alone. We plan to evaluate synergistic effects with other common aerosols present in the indoor and outdoor environments including endotoxins and sulfate aerosols (e.g. ammonium sulfate).

- Pettibone JM, Adamcakova-Dodd A, Thorne PS, O’Shaughnessy PT, Weydert JA, Grassian VH. 2008. Inflammatory response of mice following inhalation exposure to iron and copper nanoparticles. *Nanotoxicology* (1): 1–16.
- Pettibone J.B.; Elzey, S.; Grassian, V. H. “An Integrated Approach Toward Understanding the Environmental Fate, Transport, Toxicity and Health Hazards of Nanomaterials” a book chapter in *Nanoscience and Nanotechnology: Environmental and Health Impacts*, Ed. Vicki H. Grassian 2008, 43–68.
- Elzey, S.; Larsen, R.G.; Howe, C.; Grassian, V.H. “Nanoscience and Nanotechnology: Environmental and Health Impacts” in *Nanoscale Materials in Chemistry*, 2nd Edition, Editors K.J. Klabunde and R. M. Richards, John Wiley and Sons, Hoboken, NJ 2009, 676–721.
- Park, H.; Grassian, V.H. 2010. “Commercially Manufactured Engineered Nanomaterials for Environmental and Health Studies: Important Insights



Provided by Independent Characterization” Environmental Toxicology and Chemistry (29):715–721.

- Adamcakova-Dodd, A.; Thorne, P.S.; Grassian, V.H. “*In Vivo* Toxicity Studies of Metal and Metal Oxide Nanoparticles” in Handbook of Systems Toxicology, John Wiley and Sons 2010.
- Peters, T.M.; Grassian, V.H. “Engineered Nanomaterials” in Patty’s Industrial Hygiene, Sixth Edition, Eds. Vernon Rose and Barbara Cohrssen, John Wiley and Sons, 2010.
- Stebounova, L. V.; Adamcakova-Dodd, A.; Kim, J.-S.; Park, H.; O’Shaughnessy, P. T.; Grassian, V.H.; Thorne, P.S. “Nanosilver Induces Minimal Lung Toxicity or Inflammation in a Subacute Murine Inhalation Model”, Particle and Fibre Toxicology 2011, 8:5.
- Adamcakova-Dodd, A.; Kim, J.-S.; Stebounova, L. V.;’Shaughnessy, P. T.; Grassian, V.H.; Thorne, P.S. “Murine Pulmonary Responses after Sub-chronic Exposure to Aluminum Oxide Nanowhiskers”, Particle and Fibre Toxicology 2012, 9:22.
- Kim, J.-S.; Adamcakova-Dodd, A.; Park, H.; O’Shaughnessy, P. T.; Grassian, V.H.; Thorne, P.S. “Effects of Copper Nanoparticle Exposure on Host Defense in a Murine Pulmonary Infection Model”, Particle and Fibre Toxicology 2011, 8:29.
- Stebounova, L. V.; Morgan, H.; Brenner, S.; Grassian, V. H. Larissa [2012] “Health and Safety Implications of Exposure to Engineered Nanomaterials”, Nanomedicine and Nanobiotechnology 4(3):310–321.

### **VOLCKENS 9381 (R03) A Personal Sampler for Assessing Inhaled Nanoparticle Exposures**

Elucidation of potential nanoparticle exposure-disease relationships requires the development of an adequate exposure assessment method, as exposure assessment provides key input into subsequent epidemiologic and toxicological investigation. The absence of a personal exposure assessment method for nanoparticle aerosols prevents progress towards understanding potential nanoparticle exposure-disease relationships. The goal of this work is to develop an accurate, sensitive, and specific method to assess personal exposures to engineered nanoparticles. The method will assess the inhalation route of exposure, and hence, the measurement of nanoparticle concentrations in air.

To quantify concentrations of airborne nanoparticles, a measurement must be able to segregate the aerosol by size (to capture only particles smaller than 100 nm) and count these particles following size-segregation. Also, because inhaled nanoparticles enter strictly through the oral/nasal route, the method should be oriented to measure breathing zone concentrations within the vicinity of the upper torso. Finally, and perhaps most importantly, the method must be able to distinguish engineered



nanoparticles from other incidental nanoparticles (i.e., ultrafine particles) that are ubiquitous in workplace and ambient air.

Successful completion of this research will establish a method to estimate human exposures to engineered nanoparticles in workplace environments. Such a method is critical to the establishment of nanoparticle dose-response relationships, as current methods lack both specificity and sensitivity. Results from this research can also be translated to the larger realm of health-related air pollution outside of the workplace (e.g., indoor air, ambient air pollution), both nationally and internationally.

#### **RAJAGOPALAN 7963 (R44) From Nanoparticles to Novel Protective Garments**

Integration of nanocrystalline metal oxide formulations with lightweight fabric layers has been investigated and established as a plausible approach towards the development and use of reactive liners as inserts for CPC. A series of mixed metal oxide formulations were initially developed and tested for their ability to destructively absorb various TICs and CWA simulants. In addition to chemical reactivity, other properties such as granulation size and hardness were optimized for the down selected formulation. Generally, the sorbent was embedded between layers of non woven fabric to produce a laminate suitable for use as reactive liners. All the test swatches were prepared using a bench top laminator. Issues related to laminate weight and shedding of granules were addressed and resolved during the first stage of fabric lamination experiments. Comfort and chemical destruction properties were further refined during the second stage lamination experiments. Overall, the liner was optimized for the following properties: moisture vapor transfer, air permeability, chemical decontamination property, and reduced weight. As attested by industry standard test methods, these liners performed as a Class II Protective Garment for 2-CEES, HCN, NH<sub>3</sub>, and DMMP. IR and GC-MS analyses of the extracted sorbent and swatch material confirmed the degradation of DMMP and 2-CEES to less toxic by-products. Longer yardage of the down selected fabric swatch was produced by a commercial entity as well as a bench top laminator. As a proof-of-concept, a military jacket insert liner prototype was sewn from the manufactured fabric liner.

#### **DEININGER 8939-03 (R44) New Nanostructured Sensing Arrays for Hydride Detection**

DESCRIPTION (provided by applicant): Development of improved detectors for the detection of hydrides (including arsine, phosphine and diborane) will provide an increase in the protection of worker health and safety. This Phase II proposal aims to develop and demonstrate a prototype gas detection system capable of affordably and reliably detecting toxic gases at low ppb levels. Drawing upon advances in nanotechnology, micromachining and materials chemistry, the Phase I proposal demonstrated the feasibility of creating electronic sensors that are substantially better than current state of the art for hydrides detection. These improved sensors will be the basis for improved personal and permanent monitors for increased protection of workers in the semiconductor industry and other applications. Furthermore, the development of these highly innovative, sensitive and selective sensors will lay the groundwork for the

development of additional sensors for detecting a wide range of chemical hazards that exist in the workplace today. Public Health Relevance: Hydrides are dangerous gases that are widely used in the semiconductor and other industries. The proposed project will develop advanced sensors that can be used in personal protective devices to warn users about the presence of these highly toxic gases.

### **ROUTKEVITCH 902602A1 (R44) Phase II: Advanced Personal Gas Detectors for Mining Applications**

The risk of explosions in underground mines due to the presence of combustible gases is severe. The overall long-term objective of the proposed project is to develop and commercialize a new generation of affordable, reliable and portable hazardous gas detector in a Smart Gas Card format for use as a personal safety tool. The development of such an easy to use and wear personal monitor for the detection of combustible gases (e.g. methane) would be a substantial benefit to worker health and safety. In Phase I Synkera successfully demonstrated the feasibility of the critical element of such monitor, namely a low power, high performance reliable gas microsensor for detection of combustible gases. Now the objective of the Phase II effort is to advance the sensor technology to the maturity level required for portable detectors and to develop prototypes of Smart Combustible Gas Cardj. It will also facilitate the development of a Smart Multigas Card (methane, oxygen and carbon monoxide) required for each group of underground miners and for each miner who works alone. Portable combustible gas detectors on the market today typically catalytic bead sensors, or in the case of permanent installations, also infrared (IR) sensor technology. These are not suitable for personal monitoring due either bulk and cost (IR) or high power consumption (catalytic bead). Additionally, the stability and reliability of existing combustible gas sensors must be improved in order to enable fail-safe operation. Proposed new and improved catalytic combustible gas microsensors are based on a new microsensor platform technology, integrating precision-engineered nanostructured sensing elements with high surface area into a robust monolithic ceramic platform. In order to achieve the project objectives, in Phase II Synkera will (1) complete the sensor development and realize targeted performance; (2) develop and validate application-specific sensors, (3) identify and validate scale-up approaches, (4) develop low power electronics for portable Smart Card monitors, (5) fabricate Smart Combustible Gas Cardj prototypes and (6) develop partnerships for commercialization of microsensors and Smart Gas Card products. The proposed project is an opportunity to develop highly competitive products that address industry needs for personal safety tools, eliminate current cost and performance barriers, and provide a substantial benefit to worker health and safety, empowering individuals to make life-saving decisions in hazardous conditions as well during and in the aftermath of accidents. Public Health Relevance: The mining industry is one of the more challenging occupational sectors that involve adverse workers conditions, including the presence of hazardous and combustible gases. Current gas monitoring is accomplished via both fixed systems and portable instruments; however, the size and cost of current portable instruments has been a barrier to their use by all mining employees. Proposed sensor will support a new type of dramatically improved and inexpensive portable combustible gas



monitors for individual use, thus enabling a new approach to alleviating intrinsic hazards of this occupation.

### **KAGAN 8282-05 (R01) Carbon Nanotube Biodegradation by Neutrophil Myeloperoxidase**

#### **Background:**

PI: Valerian E. Kagan, PhD, DSc. Widespread applications of engineered nanomaterials, particularly carbon nanotubes (CNT), in different spheres of industry, consumer products, and medicine raise concerns about their possible adverse effects on human health in occupational settings and in the environment. The unique physico-chemical characteristics combined with the vast surface area make the biological effects of CNT largely unpredictable. Our *in vivo* studies have demonstrated robust and unusual pulmonary inflammatory/oxidative stress responses to single walled CNT (SWCNT) upon exposure of mice via aspiration or inhalation. To date, no demonstration of biodegradation of carbon nanotubes in a physiologically relevant setting has been provided. Our preliminary results demonstrate that strong oxidants such as hypochlorous acid and oxoferryl species generated as reactive products of the myeloperoxidase reaction may be effective in biodegrading SWCNT. Therefore, we hypothesized that myeloperoxidase in neutrophils has the ability to catalyze the biodegradation of SWCNT and inactivate them inducers of inflammatory responses. To determine the extent to which enzymatic catalysis by human neutrophil myeloperoxidase (hMPO) represents a novel route of biodegradation of SWCNT, we designed experiments formulated in three Specific Aims of the proposal as follows: Specific Aim 1 will determine molecular mechanisms, products and reaction pathways through which hMPO catalyzes biodegradation of SWCNT. Specific Aim 2 will define the conditions maximizing biodegradation of SWCNT in human neutrophils and determine possible contribution and role of neutrophil interactions with macrophages in the biodegradation process through the formation of redox phagocytic synapse. Specific Aim 3 will elucidate hMPO-catalyzed biodegradation of single-walled carbon nanotubes by neutrophils *in vivo* and quantitatively assess the contribution of the biodegradation process in mitigation of the SWCNT induced inflammatory responses in mouse lung. Discovery of a novel enzymatic pathway for “green” biochemical biodegradation of carbon nanotubes may revolutionize the ways to regulate their distribution in the body and contribute to a roadmap to new effective approaches to decrease their toxicity.

#### **Public Health Relevance:**

Widespread applications of engineered nanomaterials, particularly carbon nanotubes (CNT), in different spheres of industry, consumer products, and medicine raise concerns about their possible adverse effects on human health in occupational settings and in the environment. Based on known robust and unusual pulmonary pro-inflammatory effects of CNT, identification of their biodegradation pathways becomes

a necessity. We demonstrate that an enzyme of neutrophils-myeloperoxidase-has the ability to catalyze biodegradation of SWCNT and inactivate them as inducers of pulmonary inflammation thus indicating new ways to regulate their distribution in the body and reduce the toxicity.

***Peer-reviewed publications specifically credited to this project:***

Fantastic voyage and opportunities of engineered nanomaterials: what are the potential risks of occupational exposures? Kagan VE, Shi J, Feng W, Shvedova AA, Fadeel B. *J Occup Environ Med.* 2010; 52(9):943–6.

**PETERS 9920 (R21) Methods to Assess Personal Exposures to Airborne Metallic Nanoparticles**

When inhaled, nanoparticles can elicit adverse cardiopulmonary health outcomes and their toxicity, particularly for metals and metal oxides, can be substantially greater than that of larger particles of the same composition. No standard measurement methods are available to quantitatively assess personal exposures to engineered nanoparticles, and without such methods, the extent to which workers are at risk from inhalation of nanoparticles is unknown. The laboratory work proposed in this research plan will standardize and validate measurement methods needed to quantify personal exposure to a range of metallic nanoparticles that are commonly incorporated into commercial products. We will develop an innovative nanoparticle deposition (NPD) sampler to collect nanoparticles specifically (separate from the larger particles in workplace air) and in a manner that reflects their deposition in the respiratory tract (Aim 1). We will also develop and validate a method to analyze the content of metal in the nanoparticles collected with the NPD sampler (Aim 2). These sampling and analysis methods will be easily adaptable by industrial hygiene practitioners to provide the system needed to assess worker exposure to metal nanoparticles. They will also represent enabling tools to study potential epidemiological relationships among metallic nanoparticle exposures and adverse acute health effects. Public Health Relevance: This work will result in methodologies to measure personal exposure to airborne metal and metal-oxide nanoparticles. As such it is applicable to assessing worker exposures to engineered nanomaterials in the burgeoning field of nanotechnology.

**MASON 9644 Autonomous Electromechanical Gas Detection Microsystem for Mine Safety**

Despite continued safety improvements and increased regulations, underground mines remain a very dangerous work environment, as evident from recent disasters at the Sago (2006), Darby (2006), and Crandall Canyon (2007) mines. As recommended by the Mine Safety Technology and Training Commission, new, cost effective technologies are needed to enhance monitoring within mines. We propose to develop key sensor, instrumentation and data analysis technologies that will be integrated to form a miniaturized intelligent electrochemical gas analysis system (iEGAS) tailored to the needs and challenges of mine safety applications. Major innovations in diverse technical areas will be synergistically combined within the following specific aims: 1)



Develop and characterize a miniaturized electrochemical sensor array for detection and quantification of multiple mine gases, 2) Design and optimize compact electrochemical instrumentation electronics and intelligent algorithms for autonomous operation, 3) Integrate and characterize a model multigas electrochemical microsystem for mine safety monitoring and hazardous condition prediction. Through an innovative electrochemical sensor array approach, room-temperature ionic liquids and conductive polymer membranes will be developed for detection of multiple mine gases. An innovative instrumentation chip will implement multiple electrochemical measurement techniques to enable a very compact, low power microsystem implementation of the iEGAS system. New, highly efficient sensor array data analysis algorithms will enable concentrations of specific gases to be accurately measured within a mixed-gas Environment and provide pattern recognition to generate information critical to mine safety decision making. The proposed microsystem offers significant advantages over existing gas sensors. It will measure all gases linked to fires and explosions ( $\text{CH}_4$ ,  $\text{CO}$ ,  $\text{CO}_2$ ,  $\text{O}_2$ ) as well as hazardous exhaust gases ( $\text{NO}$ ,  $\text{NO}_2$ ,  $\text{SO}_2$ ). It will intelligently analyze sensor data to predict hazardous conditions, report alerts and aid escape route planning. The autonomous iEGAS system can be deployed with miners or at fixed locations within a mine for long-term monitoring without user input or training. It will be inexpensive, ultra compact and lightweight, easily carried by miners and rescue teams. It will utilize a standard interface to communicate with existing mine infrastructure or with wireless mine communication handsets to realize a highly distributed, mobile, multi-gas monitoring network. The robust sensor platform is inherently resistant to vibration, smoke, moisture, and other common mine interferents, and sensors will be internally calibrated for variable environmental conditions (temperature, humidity). An operational model of the proposed iEGAS system will be implemented and characterized in a laboratory where gas concentrations and environmental parameters can be accurately controlled to mimic the range of conditions within underground mines. The multidisciplinary team of investigators will consult with mine safety experts throughout the project to ensure the developed technologies meet mining industry needs.

#### **CHENG 9801(R01) Development of a personal sampler for nanomaterials**

Production of nanomaterials has increased continuously because of their unique physicochemical characteristics and extensive applications. There are great concerns for the potential health effects of exposure to these nanoparticles. Because of nanomaterials' small sizes and large surface areas, many studies have shown that the biological effects of nanomaterials are greater than bulk material of the same chemical composition. In 2005, the NIOSH recommended exposure limits of  $1.5 \text{ mg/m}^3$  for fine  $\text{TiO}_2$  and  $0.1 \text{ mg/m}^3$  for ultrafine  $\text{TiO}_2$ , as time-weighted average concentrations (TWA) for up to 10 hr/day during a 40-hr work week. However, there are no suitable personal samplers capable of assessing the exposure level of ultrafine or nanoparticles. The overall objective of this study is to develop a personal sampler capable of collecting the ultrafine particles (nanoparticles) in the occupational environment. This sampler consists of a cyclone for respirable particle classification, a polycarbonate track-etched (PCTE) membrane filter with an acceleration nozzle to achieve nanoparticle



classification, and a backup filter to collect nanoparticles. By applying high and localized filtration velocity in the nozzle, diffusion deposition of nanoparticles can be avoided in the classifying PCTE filter, and nanoparticles can be collected in the downstream backup filter. This research will lead to the development of a unique personal sampling device capable of classifying the nanoparticle fraction (< 100 nm) from the aerosol stream and collecting this fraction for gravimetric, chemical, and other analyses. This device can be used to accurately assess personal exposure to nanoparticles in terms of mass concentration and physicochemical characteristics. Public Health Relevance: The overall objective is to develop a personal sampler capable of collecting the ultrafine particle (nanoparticle) fraction of the aerosol in an occupation environment. It can be used to assess personal exposure to nanoparticles in terms of mass concentration and physicochemical characteristics.

### **DELOUISE 9970 (R21) Reagents to Enhance Detection of Raw and Biologically Transformed Nanomaterials**

Abstract (Official) DESCRIPTION (provided by applicant): The increasing use of engineered nanomaterials in industrial and consumer applications has raised serious concerns about their environment health safety (EH&S). A particular concern is for occupational exposure to raw materials in the form of highly dispersed spherical and fiber-like shapes. Researchers seek to quantify nanomaterial interactions with biological systems and to develop predictive models of nanoparticle EH&S risk. However, limitations imposed by the model systems employed, the lack of NP standards, the failure of researchers to quantify or report the physiochemical properties of the NP investigated, and the inadequate availability of sensitive analytical instrumentation, have collectively hampered progress in attaining these EH&S goals. In the proposed project we seek to overcome limitations in detecting nanoparticles by developing a set of reagents (NProbes) that will enhance their presence in biological tissues that due to their size may be obscured from detection by other means. NProbe reagents will function in a similar fashion to those used to detect and quantify proteins in standard immunohistological analysis. NProbes with high binding affinity to both raw NP and transformed nanomaterials will be generated using protein-based (antibody and fibronectin) phage display technology. Nanomaterials of interest include carbon nanotubes, metal oxides, metals, and semiconductors. We will validate the binding of NProbes to raw nanomaterials and test their cross reactivity to samples of related and dissimilar composition. NProbe binding to nanomaterials transformed by penetration through skin will be also be demonstrated. We believe that NProbe reagents will be useful to researchers assessing nanoparticles tissue interactions in all mammalian, vertebrate, invertebrates systems as well as detection of nanoparticles in the environment. Successfully development of NProbe reagents will have a transformative effect on nanoparticle risk assessment research. Public Health Relevance: Over the past few years the use of engineered nanomaterials in industrial and consumer applications has accelerated, raising serious concerns about the environment health safety (EH&S) risk from nanoparticle exposure. Limitations imposed by inadequate availability of sensitive analytical instrumentation have contributed to gaps in our ability to quantify the fate and transport of engineered nanomaterials. In this proposed project we address





this issue by developing a set of reagents (NProbes) that will enable detection of nanoparticles skin and in other biological or environmental systems. NProbe reagents will function in a similar fashion to those used to detect and quantify proteins in standard immunohistological analysis. NProbes with high binding affinity to both raw NP and transformed nanomaterials will be generated using protein-based (antibody and fibronectin) phage display technology.

**Specific Aims:** The goal of this project is to develop high affinity reagents (NProbes) that can bind nanomaterials with high specificity, both in the raw and transformed state, using phage display technology. These reagents will enable researchers to amplify presence of nanomaterials that have penetrated biological tissues that due to their size may be obscured from detection by other means. This technology will help fill gaps in our ability to understand and quantify parameters that influence nanomaterial penetration into biological systems. This knowledge is essential for accurately evaluating nanomaterial environmental health and safety risk. The specific aims are as follows: Aim 1 Develop Reagents with Binding Specificity to Technologically Important Nanomaterials 1.1 Hypothesis-phage display technology employing scFv and fibronectin library can be used to develop reagents (NProbes) with high binding specificity to nanomaterials Aim2 Validate Reagent Binding to Raw Nanomaterials 2.1 Hypothesis-NProbes will bind raw nanomaterials 2.2 Hypothesis-NProbe binding specificity to carbon-based NP will have cross- reactivity due to common graphene structural element 2.3 Hypothesis-NProbe binding affinity will depend on NP size and shape Aim3 Validate Reagent Binding Biologically Transformed Nanomaterials 3.1 Hypothesis-NProbes will bind nanomaterials transformed by penetration through skin 3.2 Hypothesis-NProbes will resolve discrepancy in QD skin penetration levels between TEM and visible fluorescence microscopy.

**Table 2. Nanotechnology principal investigators funded by NIOSH/OEP, 2001–2011**

<p>Yung-Sung Cheng Lovelace Biomed/Environ Res Inst Department of Toxicology 2425 Ridgecrest Drive SE Albuquerque, NM 87108 (505) 348-9410 (t)/ (505) 348-8567 (f) ycheng@lrri.org 1R010H009801-01A1 (2010)</p>	<p>Debra J. Deininger Synkera Technologies, Inc. 2021 Miller Drive, Suite B Longmont, CO 80501 (720) 494-8401 (t)/(720) 494-8402 (f) ddeininger@synkera.com 1R430H008939-01 (2006) 5R440H008939-03 (2009)</p>
<p>Lisa A. Delouise, PhD, MPH University of Rochester Medical Center School of Medicine and Dentistry 601 Elmwood Ave, Box 697 Rochester, NY 14642 (585) 275-1810 (t)/(585) 273-1346 (f) lisa_delouise@urmc.rochester 1R210H009970-01 (2011)</p>	<p>Prabir K. Dutta The Ohio State University Department of Chemistry 1960 Kenny Road Columbus, OH 43210 (614) 292-4532 (t)/(614) 292-1685 (f) dutta.1@osu.edu 1R010H009141 (2006)</p>
<p>Vicki H. Grassian Professor and Institute Director Nanoscience &amp; Nanotechnology Institute University of Iowa The University of Iowa Iowa City, IA 52242 (319) 384-3292 (t)/(319) 353-1115 (f) vicki-grassian@uiowa.edu 1R010H009448-01 (2008)</p>	<p>Professor Valerin E. Kagan, Ph.D., D.Sc. University of Pittsburgh Department of Environmental and Occupational Health Bridgeside Point 100 Technology Drive, Suite 350 Pittsburgh, PA 15129 (412) 624-9479 (t)/(412) 624-9361 (f) kagan@pitt.edu 1R010H008282-01A (2005) 2R010H008282-05 (2010)</p>
<p>Andrew Mason, PhD Michigan State University Department of Electrical &amp; Computer Engineering 2120 Engineering Bldg. East Lansing, MI 488241226 (517) 355-6502 MASON@EGR.MSU.EDU 5R010H09644-02 (2010)</p>	<p>Patrick Thomas O'Shaughnessy University of Iowa Department of Occupational and Environmental Health 100 Oakdale Campus, 137 IREH Iowa City, IA 52242-5000 (319) 335-4202 (t)/(319) 335-4225 (f) Patrick-Oshaughnessy@uiowa.edu 1R010H008806-01 (2005)</p>

(continued)

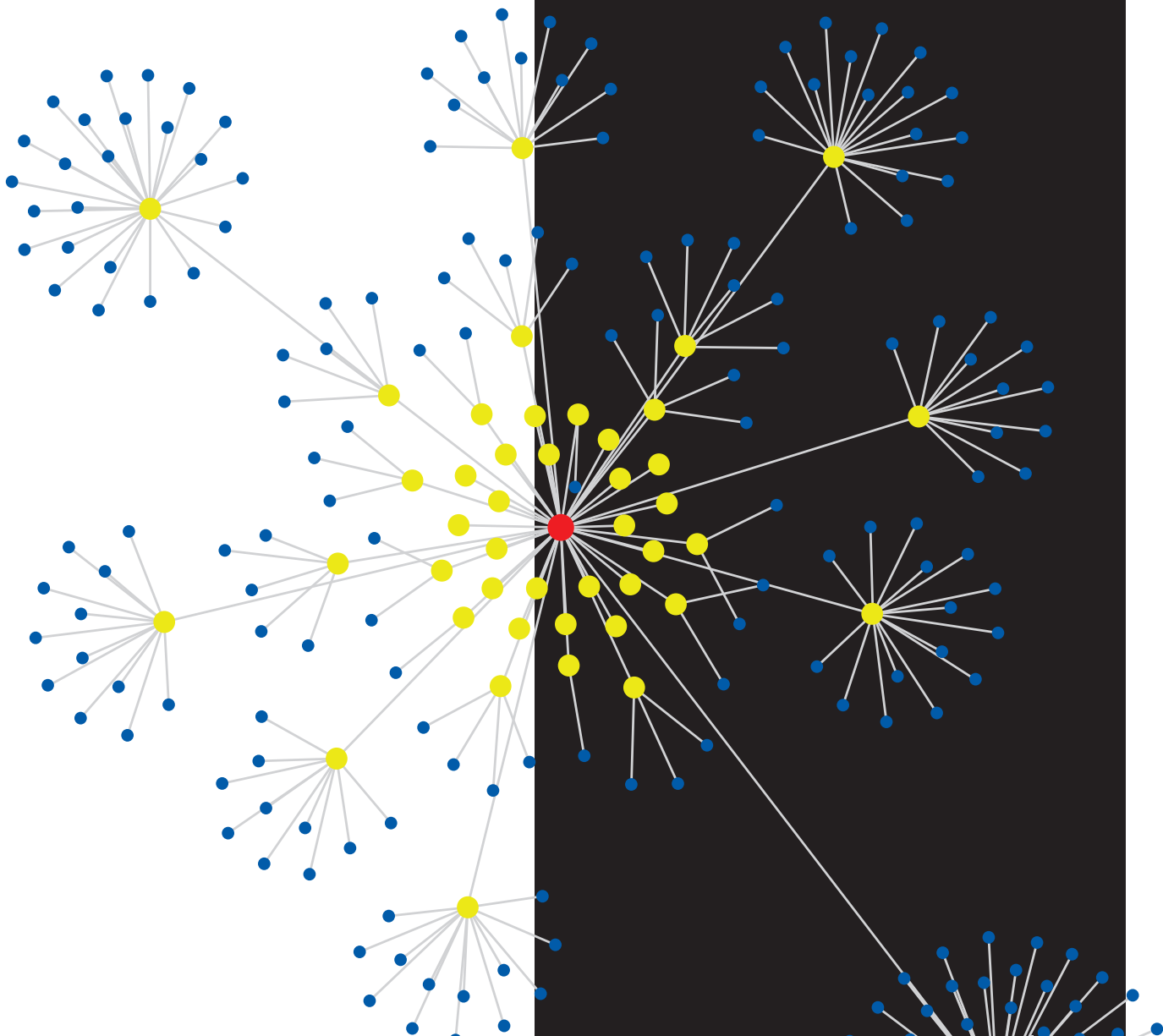

**Table 2 (Continued). Nanotechnology principal investigators funded by NIOSH/OEP, 2001–2011**

Thomas M. Peters University of Iowa Department of Occupational and Environmental Health 100 Oakdale Campus, 102 IREH Iowa City, IA 52242–5000 (319) 335–4436 (t)/ (319)335–4225 (f) thomas-m-peters@uiowa.edu 1K010H009255–01 (2007) 1R210H009920–01 (2010)	Shymala Rajagopalan NanoScale Materials, Inc. 1310 Research Park Dr. Manhattan, KS 66502 (785) 537–0179 (t)/(785) 537–0226 (f) srajagopalan@nanoactive.com www.nanoactive.com 1R430H007963–01A1 (2004) 2R440H007963–02 (2008)
Dmitri Routkevitch Synkera Technologies Inc 2021 Miller Drive, Suite B Longmont, CO 80501 droutkevitch@synkera.com (720) 494–8401 x102 5R440H009026–03 (2009)	Joel S. Thompson Eltron Research 4600 Nautilus Court South Boulder, CO 80301–3241 (303) 530–0263 Ext. 118 (t); (303) 530–0264 (f) eltron@eltronresearch.com 1R430H008739–01 (2006)
Charles Timchalk Battelle Memorial Institute Health Effects & Risk Scis Pacific NW Division, Box 999 RICHLAND, WA 99352 (509) 376–0434 (t)/(509) 376–9064 (f) charles.timchalk@pnl.gov 5R010H008173–05 (2006)	Dr. John Volckens 153 Environmental Health Building Colorado State University Fort Collins, CO 80523–1681 (970) 491–6341 (t); (970) 491–2940 (f) John.Volckens@colostate.edu 1R030H009381 (2008)
Stephen Williams Synkera Technologies, Inc. 2021 Miller Drive, Suite B Longmont, CO 80501 (720) 494–8401 (t)/(720) 494–8402 (f) swilliams@synkera.com 2R440H007471–02 (2003)	Judy Xiong New York University School of Medicine Environmental Medicine 57 Old Forge Road Tuxedo, NY 10987 (845) 731–3627 (t)/(845) 351–5472 (f) xiongji@env.med.nyu.edu 1R010H008807–01 (2005)

# NIOSH Logic Model

## APPENDIX D





## NIOSH Logic Model

Like other scientific organizations, NIOSH can be described by a model of the way it functions to solve identified problems under various conditions. The overall NIOSH logic model is presented in Figure D-1. It has a conventional horseshoe shape with the operational upper branch proceeding from inputs to outcomes and with the strategic lower branch proceeding from strategic goals to management objectives. Both branches are correlated vertically and are subject to external factors.

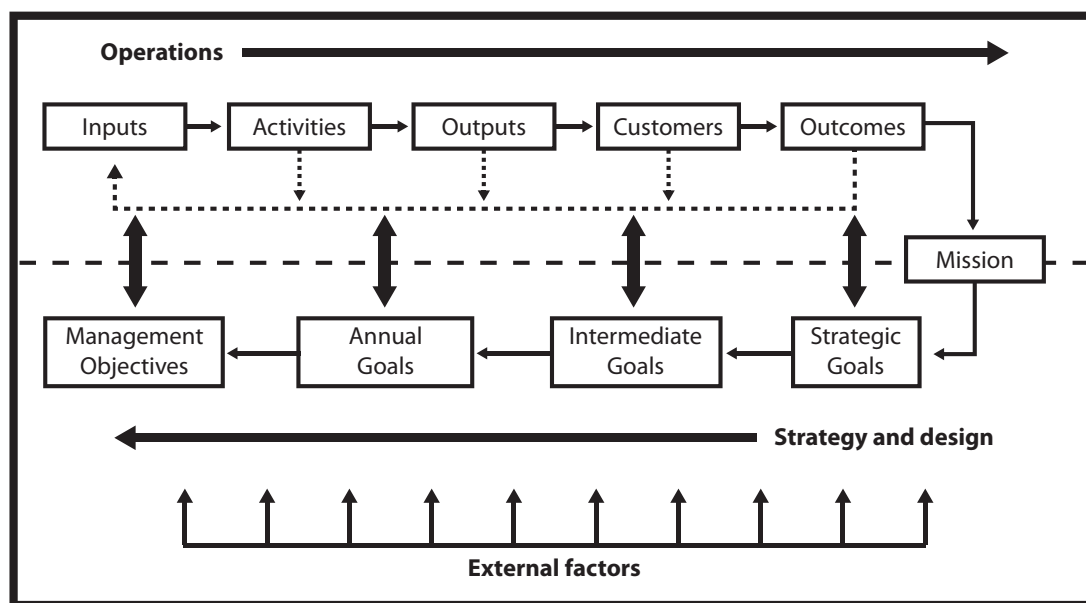

**Figure D-1.** Schematic of the overall NIOSH logic model.

The NIOSH research program begins with an analysis of production and planning inputs and follows the NIOSH operational model (Figure D-2). This analysis determines what can and should be done and thereby identifies research priorities. Intramural and extramural researchers present their project proposals, which receive appropriate internal and external review and are funded on the basis of proposal merits. Research activities produce outputs such as published materials, oral presentations, training and educational materials, tools, methods, and technologies. NIOSH research outputs are transferred directly to the final customers and partners (who implement improvements in workplace safety and health) or to intermediate customers (who transform further NIOSH outputs and produce intermediate outcomes). These intermediate outcomes such as training programs, regulations and standards are forwarded to the final customers. Since NIOSH is not a regulatory agency, it relies heavily on efforts by intermediate and final customers to achieve ultimate outcomes in the form of workplace safety and health improvements.

Effectiveness in achieving these ultimate outcomes is influenced at all stages of program operation by both external factors (such as economic and social conditions) and the regulatory environment. Results of NIOSH-funded research and customer feedback (intermediate and final) contribute to the subsequent rounds of program planning.

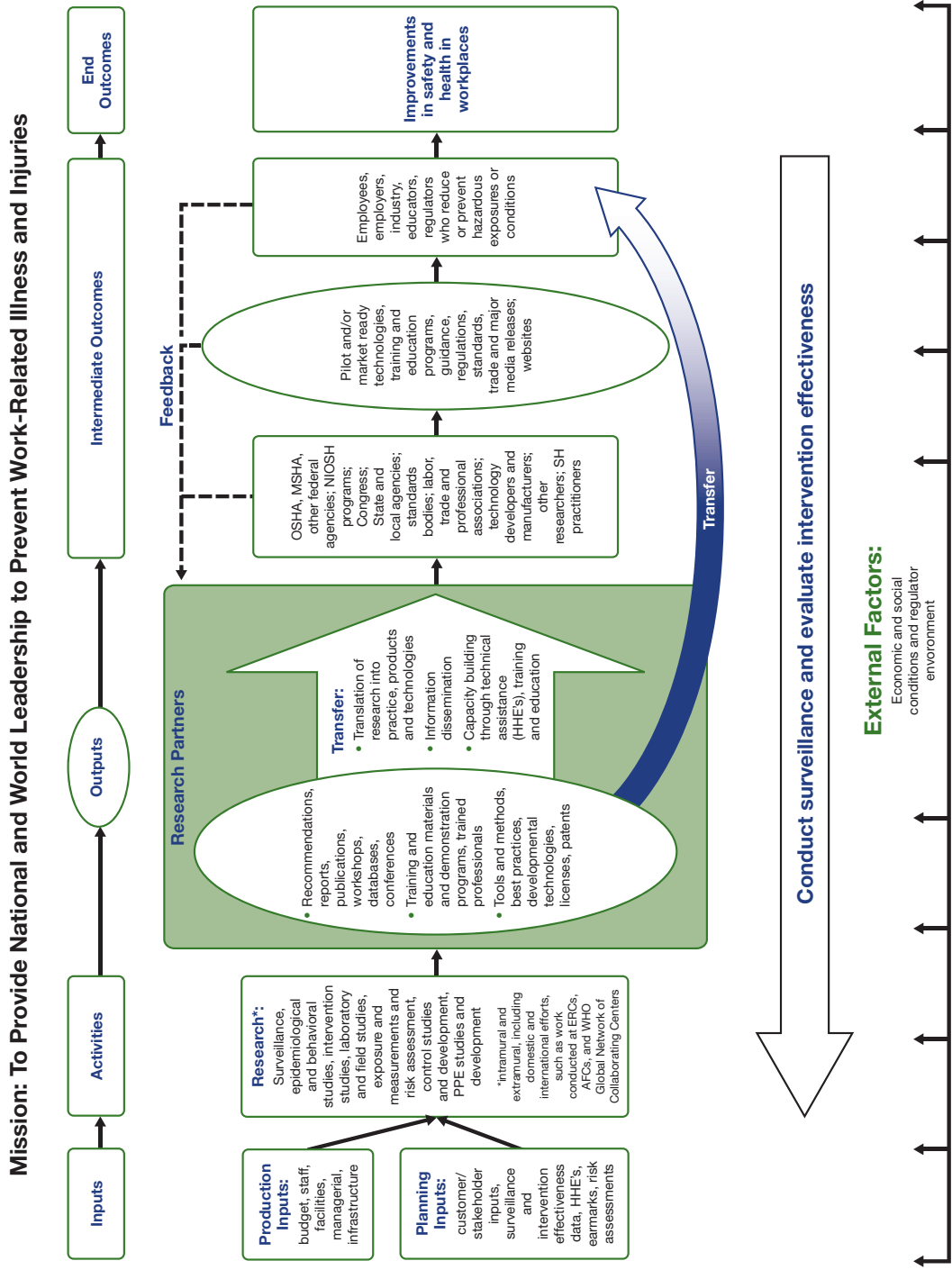

Figure D-2. Schematic of the NIOSH operational model.





# Progress Toward Meeting the NTRC Performance Measures

## APPENDIX E

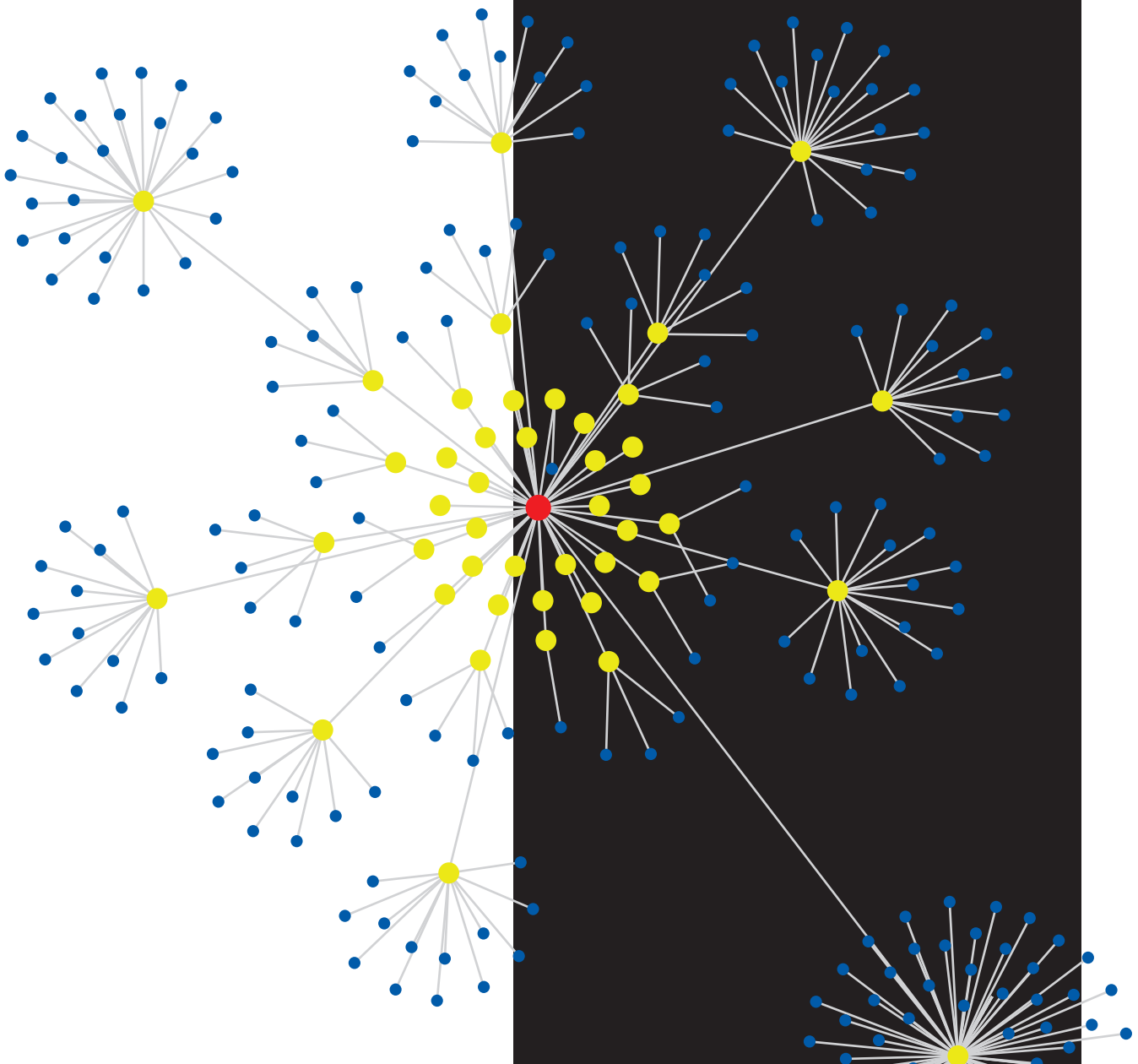



**Table E1. Progress toward meeting the NTRC performance measures**

<b>2009 Strategic plan performance measure (Measure numbers are from the Strategic Plan, NIOSH Pub No. 2010-105)</b>		<b>Progress as of Dec 31, 2011</b>
<b>NTRC critical research area</b>		
Toxicity and internal dose	1.1.1 Elucidate toxicological mechanisms over the next five years (2009-2013)	Determined the pulmonary response (dose dependence and time course) to single-walled carbon nanotubes (SWCNT) and testing continues with multi-walled carbon nanotubes (MWCNT). Cardiovascular response to pulmonary exposure to SWCNT and ultrafine titanium dioxide completed. Determination of the pulmonary deposition and fate of SWCNT, MWCNT and ultrafine TiO <sub>2</sub> continues. The <i>in vitro</i> effects of SWCNT and metal oxide nanoparticles on skin cells is ongoing. Genotoxic and carcinogenic effects of SWCNT are being studied. Central nervous system effects of pulmonary exposure to nanoparticles is ongoing.
Toxicity and internal dose	1.1.2 Address the development of predictive algorithms for toxicity over the next five years	Testing continues to determine the role of oxidant-generating potential, shape (nanospheres vs. nanowires), diameter and length in bioactivity of metal oxide nanoparticles and carbon nanotubes. <i>In vitro</i> assays for oxidant generation, fibrogenic potential, and ability to cause endothelial dysfunction are ongoing.
Toxicity and internal dose	1.1.3 Address issues of most appropriate dose metric over the next three years.	Determined the pulmonary response to exposure to fine vs. ultrafine particles using both mass and surface area as the dose metric. Continuing to coordinate dose metrics with the field sampling capabilities.

(continued)

**Table E1 (Continued). Progress toward meeting the NTRC performance measures**

NTRC critical research area	2009 Strategic plan performance measure (Measure numbers are from the Strategic Plan, NIOSH Pub No. 2010-105)	Progress as of Dec 31, 2011
Toxicity and internal dose	1.1.4 Address issues of internal dose over the next five years	Developing methods to label carbon nanotubes and track their pulmonary deposition and fate (i.e., clearance, interstitialization, and translocation) with time post-exposure. Using chemical analysis to track the deposition and fate of metal oxide nanoparticles.
Measurement methods	1.2.1-1 Within three years evaluate the correlation between particle number, surface area, mass, and particle size distribution airborne measurement results and provide guidance for sampler selection based on the nanomaterial of interest.	Evaluating current methods for measuring airborne mass concentrations of respirable particles in the workplace and investigating whether these mass-based methods can be used as an interim approach for measuring nanomaterials in the workplace. Recommended a quantitative selective mass based approach (elemental carbon) for the CNT REL based on previous published work [Birch et al. 2011]. Results of chamber studies comparing various methods for determination of aerosol surface area have been published. Particle number, active surface area and respirable mass were compared in a published CNF workplace study [Evans et al. 2010]. Particle size distributions were also monitored. Respirable mass was found to be the most useful and practical metric for monitoring CNFs and likely other nanoscale powders. Use of a photometer (response proportional to mass) was recommended.

(continued)



**Table E1 (Continued). Progress toward meeting the NTRC performance measures**

NTRC critical research area	2009 Strategic plan performance measure (Measure numbers are from the Strategic Plan, NIOSH Pub No. 2010-105)	Progress as of Dec 31, 2011
Measurement Methods	1.2.1-2 Continue to conduct measurement studies of nanoparticles in the workplace over the next five years and establish a suite of instruments and protocols for nanoparticle measurement in the workplace.	The Nanomaterial Emission Assessment Technique was developed and refinement continues with the collection of exposure samples, use of data logging and additional instrumentation and mass based sampling in the field (Methner et al 2010). Following published workplace study findings with CNFs (Evans et al. 2010, Birch et al. 2011), time integrated sampling and direct reading instruments are being applied to an industry-wide study on CNT/CNF exposures (Dahm et al. 2012).
Measurement Methods	1.2.1-3 Continue with refining NIOSH Method 5040 specifications for the collection of elemental and organic carbon for application to the collection of carbon nanotubes and nanofibers.	An Appendix was added to the draft 2010 CIB on CNT/CNF describing modifications to Method 5040 for CNT/CNF. Quantitative worker exposures have been and continue to be determined using NIOSH 5040 (Birch et al. 2011, Dahm et al. 2012).
Measurement Methods	1.2.2 Within five years develop a handheld fast-response nanoparticle monitor and software for spatial mapping of nanoparticles	A prototype hand held electrostatic precipitator was developed and licensed to a vendor. A Portable Aerosol Mobility Spectrometer (PAMS) has been fully developed and validated, and a Personal Nanoaerosol Sizer (PNS) prototype has been completed and its performance is being evaluated. No progress on software for spatial mapping. For nanomaterial handling, spatial concentration mapping may not be the most efficient tool for workplace evaluations.

(continued)

**Table E1 (Continued). Progress toward meeting the NTRC performance measures**

NTRC critical research area	2009 Strategic plan performance measure (Measure numbers are from the Strategic Plan, NIOSH Pub No. 2010-105)	Progress as of Dec 31, 2011
Measurement Methods	1.2.3 Within three years publish procedures for validation of nanoparticle sampling instruments and methods.	Developing testing and evaluation systems for comparison and validation of nanoparticle sampling instruments and methods. A workplace aerosol sampling platform was developed for simultaneous monitoring and comparison of an array of aerosol instruments and metrics [Evans et al. 2010]. Laboratory and field work continues.
Measurement Methods	1.2.4 Within three years strengthen interactions with the National Institute of Standards and Technology to identify commercially available nanomaterials and perform coherent research to develop and qualify nanoscale reference materials (RMs) and benchmark materials for evaluating measurement tools, instruments, and methods	Collaborating with NIST to identify and qualify scientifically credible, nanoscale certified reference materials (RMs) with assigned physical and/or chemical values for use in evaluating measurement tools, instruments, and methods. Collaboration has resulted in production of a certified reference material for specific surface area. Using NIST RM for particle size to evaluate TEM analysis. Additionally, the NTRC is collaborating with National Research Council—Canada on qualification of three high-aspect ratio nanoparticle reference materials.
Exposure Assessment	1.3.1 Support at least 12 research projects (field trips) over the next three years (2009-2011) to assess the fate of nanomaterials in the work environment.	Between 2009-2011 a total of 27 field trips were completed by members of the various NTRC field research teams. The increase in the amount of field studies is because the initial goal of 12 visits did not include the industrywide study to evaluate exposures in the carbonaceous nanomaterial facilities nor additional studies to evaluate method development and engineering controls.

(continued)



**Table E1 (Continued). Progress toward meeting the NTRC performance measures**

NTRC critical research area	2009 Strategic plan performance measure (Measure numbers are from the Strategic Plan, NIOSH Pub No. 2010-105)	Progress as of Dec 31, 2011
Exposure Assessment	1.3.2 Within three years (2009-2011) develop a baseline worker exposure assessment that identifies how exposures differ by work task or process.	Quantitatively assessing exposures to nanomaterials in the workplace including inhalation and dermal exposure. Determining how exposures differ by work task or process. Baseline database not created.
Epidemiology and Surveillance	1.4.1 Over the next three years, seek input from a collaborative working group made up of representatives from industry, government, academia, and labor concerning the value and utility of establishing exposure registries for workers potentially exposed to engineered nanoparticles.	(1) Co-sponsored a Keystone conference in Keystone, Colorado in 2010, [Nanomaterials and Worker Health: Medical Surveillance, Exposure Registries, and Epidemiologic Research] attended by a diverse group of national and international stakeholders. Working group findings from this conference were published in a Journal of Occupational and Environmental Medicine (JOEM) Supplement; (2) Participating in European working groups to ensure consistency between US and EU exposure databases.
Epidemiology and Surveillance	1.4.2 Over the next three years assess the feasibility of industry-wide exposure and epidemiological studies of workers exposed to engineered nanomaterials.	Evaluated the need for and feasibility of initiating epidemiological or other health studies in workers exposed to carbonaceous nanomaterials. Completed the feasibility study.

(continued)

**Table E1 (Continued). Progress toward meeting the NTRC performance measures**

NTRC critical research area	2009 Strategic plan performance measure (Measure numbers are from the Strategic Plan, NIOSH Pub No. 2010-105)	Progress as of Dec 31, 2011
Epidemiology and Surveillance	<p>1.4.3 Finalize the “Interim Guidance for the Medical Screening and Hazard Surveillance of Workers Potentially Exposed to Engineered Nanoparticles” by 2009, followed by an update within the following three years. Investigate the feasibility of establishing a registry of workers exposed to engineered nanoparticles.</p>	<p>The CIB 60: <i>Interim Guidance for the Medical Screening and Hazard Surveillance of Workers Potentially Exposed to Engineered Nanoparticles</i> was published in 2009 (NIOSH Pub No. 2009-116). Updates of medical screening and hazard surveillance guidance are being provided in an “agent-specific” manner; guidance has been prepared for titanium dioxide and is in review status for carbon nanotubes and nanofibers.</p>
Epidemiology and Surveillance	<p>1.4.4 By 2012, create a GIS infrastructure populated with nanotechnology exposure data.</p>	<p>Initial investigations into the feasibility of nanotechnology worker registries have been conducted at 2010 Keystone, CO, conference: <i>Nanomaterials and Worker Health: Exposure Registries, Medical Surveillance and Epidemiologic Research</i>. Those efforts were summarized in a Supplement of JOEM dedicated to the conference. Feasibility of such registries is a continuing topic of investigation and discussion in various forums with stakeholders.</p> <p>Minimal progress. Collection of exposure data is ongoing.</p>

(continued)





**Table E1 (Continued). Progress toward meeting the NTRC performance measures**

NTRC critical research area	2009 Strategic plan performance measure (Measure numbers are from the Strategic Plan, NIOSH Pub No. 2010-105)	Progress as of Dec 31, 2011
Risk Assessment	<p>1.5.1 Within three years complete a quantitative risk assessment (QRA) on ultrafine and fine materials from existing studies. Evaluate QRA methods for nanomaterials. Start QRA for nanoparticles using new NIOSH data. Use NIOSH nanoparticle data to calibrate and validate dosimetry models for nanoparticles.</p>	<p>QRAs on airborne exposure to ultrafine and fine TiO<sub>2</sub> were completed, using dose-response data from sub-chronic and chronic inhalation studies in animals. This QRA provided the health basis for the NIOSH recommended exposure limits (RELS) for airborne exposure to nanometer-diameter (ultrafine) and micrometer-diameter (fine) respirable TiO<sub>2</sub> (NIOSH Pub No. 2011-160). QRA methods were evaluated in that document and in peer reviewed publications (e.g., Kuempel et al. 2009; Kuempel 2011). A QRA on carbon nanotubes (CNT) and carbon nanofibers (CNF) was completed, which provided the health basis for the NIOSH draft REL for CNT and CNF (NIOSH 2010). New NIOSH data from toxicology and aerosol research studies were used for those QRAs. Dosimetry model calibration, evaluation, and validation have been completed through collaboration with NIOSH partners (MacCalman et al. 2009; Sweeney et al. in preparation). New research was initiated in 2011 to develop a human respiratory tract deposition model of airborne CNT.</p>
Risk Assessment	<p>1.5.2 Within five years develop a risk assessment framework to rank hazard and estimate risk from exposure to selected nanoparticles in the workplace.</p>	<p>Began development of a risk assessment framework for evaluating the hazard and predicting the risk of exposure to nanoparticles. New data from <i>in vitro</i> and <i>in vivo</i> toxicology tests of several types of nanomaterials from NIOSH and external partners are being utilized in these hazard and risk assessments.</p>

(continued)

**Table E1 (Continued). Progress toward meeting the NTRC performance measures**

<b>2009 Strategic plan performance measure (Measure numbers are from the Strategic Plan, NIOSH Pub No. 2010-105)</b>		<b>Progress as of Dec 31, 2011</b>
<b>NTRC critical research area</b>		
Engineering Controls and Personal Protective Equipment	3.1.1 Conduct field investigations of workplaces where nanoparticles are manufactured and used and evaluate existing engineering controls. Within three years publish updated engineering control guidance.	Four field investigations have been conducted and one engineering control survey report released to the sponsoring facility. Drafts of the reports for the remaining three facilities along with two case study reports are in progress. Engineering control evaluations are ongoing and a draft engineering control guidance document has been created. External review and completion of the document on target for late 2012.
	3.1.2 Within five years publish updated guidance on the effectiveness of PPE for reducing worker exposures to nanoparticles	Researchers have evaluated respiratory protection and other types of PPE for use with nanomaterials and published journal articles and a NIOSH Science Blog. <a href="http://blogs.cdc.gov/niosh-science-blog/2011/12/resp-nano/">http://blogs.cdc.gov/niosh-science-blog/2011/12/resp-nano/</a>
Engineering Controls and Personal Protective Equipment	3.1.3 Within five years publish updated respiratory protection guidance.	Research is ongoing. Expanding respirator research from bench to human subject studies and to the field. Work on gloves has not been done, but still remains a need. There are still some data gaps relevant to protective clothing materials that need addressed.
Engineering Controls and Personal Protective Equipment		Ongoing. Journal publications pertaining to nanomaterial leakage and filtration published. Updated respiratory protection guidance in the CIB on TiO <sub>2</sub> , in the 2010 <i>Approaches to Safe Nanotechnology</i> , DHHS (NIOSH) Pub No. 2010-125, the CIB on CNT/CNF, and in the Science Blog.

(continued)



**Table E1 (Continued). Progress toward meeting the NTRC performance measures**

NTRC critical research area	2009 Strategic plan performance measure (Measure numbers are from the Strategic Plan, NIOSH Pub No. 2010-105)	Progress as of Dec 31, 2011
Engineering Controls and Personal Protective Equipment	3.1.4 Within five years publish updated work practice and administrative control guidance.	Ongoing. <i>Approaches to Safe Nanotechnology</i> DHHS (NIOSH) Pub No. 2010-125 was published in 2010 and will be updated as new information becomes available. General Safe Practices for Working with Engineered Nanomaterials in Research Laboratories, DHHS (NIOSH) Pub No. 2012-147 was published in 2012. An Engineering Control document is scheduled to be published late in 2012.
Engineering Controls and Personal Protective Equipment	3.1.5 Within three years publish a document on the suitability of control banding approaches for nanomaterials.	Document delayed due to need for hazard banding prior to control banding. Investigating the ability to hazard group nanomaterials by physico chemical or other relevant properties.
Engineering Controls and Personal Protective Equipment	3.1.6 Support at least three projects over the next five years to evaluate substitute and modified nanoparticles with toxicological studies.	Prevention through design (PtD) work is ongoing. Conference to address safe nano design, molecule-> manufacturing -> market held in August 2012.
Fire and Explosion Safety	3.2.1 Support at least two projects to evaluate explosion and fire hazards. Within three years publish guidance to eliminate or reduce explosion and fire hazards.	Researchers evaluated the toxicity of functionalized versus pristine MWCNT.  Physical and chemical properties that contribute to dustiness, combustibility, flammability, and conductivity of nanomaterials is ongoing. Recommendation of appropriate work practices to eliminate or reduce the risk to explosions and fire not yet begun.

(continued)

**Table E1 (Continued). Progress toward meeting the NTRC performance measures**

NTRC critical research area	2009 Strategic plan performance measure (Measure numbers are from the Strategic Plan, NIOSH Pub No. 2010-105)	Progress as of Dec 31, 2011
Recommendations and Guidance	3.3.1 Update and finalize the document, <i>Approaches to Safe Nanotechnology, Managing the Health and Safety Concerns Associated with Engineered Nanomaterials</i> by 2009. Within two years, produce brochures and fact sheets to provide guidance to workers and laboratory staff. Continue to look for opportunities to translate research from the critical research areas into practice.	Approaches to Safe Nanotechnology was updated and published; DHHS (NIOSH) Pub No. 2010-125. <i>General Safe Practices for Working with Engineered Nanomaterials in Research Laboratories</i> ; DHHS (NIOSH) Pub No. 2012-147 published. An Engineering Control document is scheduled to be published late in 2012.
Recommendations and Guidance	3.3.2 By 2009, complete the CIB, <i>Evaluation of Health Hazard and Recommendations for Occupational Exposure to Titanium Dioxide</i> , with the OEL for ultrafine titanium dioxide. Support a project over the next three years to evaluate other ultrafine or nanoparticle OELs. Develop a CIB on carbon nanotubes by 2011.	The CIB on titanium dioxide was finalized in early 2011, DHHS (NIOSH) Pub No. 2011-160). The draft CIB on CNT/CNF was published on the NIOSH web page for public review in December 2010; a final document is scheduled for completion in 2012.
Recommendations and Guidance	3.3.3. Initiate a project that will develop a classification scheme based on chemical and physical properties. Release this classification scheme within the next three years.	Risk assessment project to classify nanomaterials based on toxicologic relevance is ongoing. Began development of a risk assessment framework for evaluating the hazard and predicting the risk of exposure to nanoparticles. New data from <i>in vitro</i> and <i>in vivo</i> toxicology tests of several types of nanomaterials from NIOSH and external partners are being utilized in these hazard and risk assessments. May need to extend target completion date.

(continued)



**Table E1 (Continued). Progress toward meeting the NTRC performance measures**

NTRC critical research area	2009 Strategic plan performance measure (Measure numbers are from the Strategic Plan, NIOSH Pub No. 2010-105)	Progress as of Dec 31, 2011
Recommendations and Guidance	3.3.4 Support a project to evaluate the existing toxicity information of high production volume nanoscale materials.	Nanotoxicology projects investigated the high volume materials SWCNT and MWCNT. Fullerenes and silver are scheduled to be evaluated.
Recommendations and Guidance	3.3.5 Within three years, increase awareness of the need for specific nanomaterial information on MSDS among the target audience by 33% over baseline.	Two posters presented at AIHce 2009 and 2011 demonstrated that there has been little progress in the improvement of nanomaterial safety data sheets. A critical evaluation of material safety data sheets (MSDSs) for engineered nanomaterials (Eastlake et al. 2012) published in the <i>Journal of Chemical Health and Safety</i> to reach a broader audience so that nano manufacturers understand the need to identify the nano material and conduct annual literature searches for recent toxicologic info to include on the MSDSs.
Communications and Information	4.1.1. Creation of a roadmap that aligns new nanoinformatics with the NIOSH Nanoparticle Information Library (NIL) within the next three years (2009-2011).	The NIL was migrated to Oregon State, ONAMI, as a solution to open access and maintenance issues. Specific nanoinformatics project areas were identified through NIOSH participation in the NanoInformatics 2011 workshops held in November 2010 and December 2011, and through creation of the NanoInformatics 2020 Roadmap (available at <a href="http://eprints.internano.org/607/1/Roadmap_FINAL041311.pdf">http://eprints.internano.org/607/1/Roadmap_FINAL041311.pdf</a> ).

(continued)

**Table E1 (Continued). Progress toward meeting the NTRC performance measures**

NTRC critical research area	2009 Strategic plan performance measure (Measure numbers are from the Strategic Plan, NIOSH Pub No. 2010-105)	Progress as of Dec 31, 2011
Communications and Information	<p>4.1.2 Within one year, identify and initiate/establish contact with at least one potential partner from each of the following areas: government, industry, academia, and labor.</p>	<p>Many new contacts were made between 2009-2011 including formal MOUs with the National Science Foundation Center for High-rate Nanomanufacturing, in collaboration with the University of Massachusetts Lowell, Northeastern University, and the University of New Hampshire; and with the College of Nanoscale Science and Engineering, State University of New York-Albany (CNSE).</p>
Communications and Information	<p>4.1.3 Within one year, develop at least one informational document tailored to a target audience nanotechnology workers and employers, occupational safety and health professionals, policy-makers, or decision-makers. Evaluate/assess the reach and effectiveness of the above tailored informational piece within two years.</p>	<p><i>Approaches to Safe Nanotechnology: Managing the Health and Safety Concerns Associated with Engineered Nanomaterials</i> was updated in 2010; DHHS (NIOSH) Publication No. 2010-125, and <i>General Safe Practices for Working with Engineered Nanomaterials in Research Laboratories</i>; DHHS (NIOSH) Pub No. 2012-147 was published in 2012. An Impact card was created by the Office of Health Communications to highlight the <i>Approaches to Safe Nanotechnology</i> document DHHS (NIOSH) Publication No. 2011-206.</p>
		<p>The effectiveness of the guidance was evaluated as part of an epidemiology feasibility project and a journal article summarizing adherence was drafted.</p>

(continued)





**Table E1 (Continued). Progress toward meeting the NTRC performance measures**

NTRC critical research area	2009 Strategic plan performance measure (Measure numbers are from the Strategic Plan, NIOSH Pub No. 2010-105)	Progress as of Dec 31, 2011
Communications and Information	4.1.3 Update progress report on the NIOSH nanotechnology research and communication efforts within two years. Continue to update the document, <i>Approaches to Safe Nanotechnology: Managing the Health and Safety Concerns Associated with Engineered Nanomaterials</i> as new information becomes available.	2012 update of the Progress Report completed herein. It includes updating all NIOSH nanotechnology research from 2004-2011. <i>Approaches to Safe Nanotechnology</i> [NIOSH Publication 2010-125] is being evaluated for an update involving an updated appendix on exposure assessment.
Applications for Occupational Safety and Health	2.1.1 Support at least three projects over the next three years to evaluate the application of nanotechnology in the manufacture of filters, respirators, and respirator cartridge end-of-service indicator.	NTRC researchers have developed nano enabled sensors (end of life service indicators) and integrated them into air purifying respirator (APR) and powered air purifying respirator (PAPR) cartridges for evaluation. Research findings are now being used in the update of NIOSH PAPR respirator standards. NTRC researchers also collaborated and developed new nanomaterials for chemical sensing (see performance measure 2.1.2).
Applications for Occupational Safety and Health	2.1.2 Within five years publish application findings and disseminate findings to workers, employers, and occupational safety and health professionals.	NTRC researchers collaborated and developed new nanomaterials for chemical sensing. This research resulted in a patent assigned to the Regent of the University of California: Sailor, Ruminaki, King, and Snyder, "Optical fiber-mounted porous photonic crystals and sensors," U.S. Patent #7,889,954, issued Feb. 15, 2011.

(continued)



**Table E1 (Continued). Progress toward meeting the NTRC performance measures**

NTRC critical research area	2009 Strategic plan performance measure (Measure numbers are from the Strategic Plan, NIOSH Pub No. 2010-105)	Progress as of Dec 31, 2011
International Activities	4.2.1-1 Strengthen coordination of research through government-level organizations (OECD and WHO).	Additional NTRC researchers were asked to participate on global nanotechnology OH&S programs. NTRC researchers participated in several joint EU/US conferences. NTRC researchers initiated development of <i>WHO Guidelines on Protecting Workers from Potential Risks of Manufactured Nanomaterials</i> ( <a href="http://www.who.int/occupational_health/topics/nanotechnologies/en/">http://www.who.int/occupational_health/topics/nanotechnologies/en/</a> )
International Activities	4.2.1-2 Expand collaborations to developing nations and emerging powers (Asia-Pacific, Eastern Europe).	NTRC researchers participated in meetings held in Australia, Japan, and India during 2009-2011. Many of the EU workshops attended by NTRC researchers also included attendees from Poland and the Czech Republic. NTRC researchers established collaborations with research labs in Russia.
International Activities	4.2.2-1 Develop global portal for information on nanomaterials relevant to occupational safety and health.	NIOSH nanotechnology topic page has been widely used by the international community. NIOSH sponsors the GoodNanoGuide portal bringing together health and safety professionals to exchange experiences and good practices in the workplace. NTRC researcher leads the development of nanotechnology topic page in World Health Organization ( <a href="http://www.who.int/occupational_health/topics/nanotechnologies/en/">http://www.who.int/occupational_health/topics/nanotechnologies/en/</a> )

(continued)



**Table E1 (Continued). Progress toward meeting the NTRC performance measures**

NTRC critical research area	2009 Strategic plan performance measure (Measure numbers are from the Strategic Plan, NIOSH Pub No. 2010-105)	Progress as of Dec 31, 2011
International Activities	4.2.2-2 Develop global exposure registry data-base: European countries, ECHA, Asian countries, OECD.	Coordinating efforts between NIOSH, the TNO, PEROSH, and NanolmpactNet for a global exposure registry database. Discussions underway but no database yet. Leading development of a health surveillance project incorporating exposure registries in IOHA. The nano proposal to IOHA was 'received favorably' in 2011.
International Activities	4.2.2.3 Participate in OECD Nanomaterial Safety Testing Program by sponsoring nanomaterial testing and by data exchange.	NIOSH conducts research and acts as contributor for OECD for several nanomaterials: silver, single and multi-wall carbon nanotubes, and fullerenes.
International Activities	4.2.3-1 Facilitate development of government-level exposure mitigation guidance (OECD).	NTRC researcher leads the OECD steering group developing guidance on exposure mitigation. Most recently this steering group published a compilation of occupational guidance for nanotechnology laboratories. Presently this steering group is developing guidance on measuring exposures to airborne nanomaterials.
International Activities	4.2.3-2 Increase utilization of web-based tools for document development (such as wiki-based platforms	NIOSH sponsors the GoodNanoGuide portal, based on wiki, bringing together health and safety professionals to exchange experiences and develop best practice guidance for nanotechnology workplaces.

(continued)

**Table E1 (Continued). Progress toward meeting the NTRC performance measures**

NTRC critical research area	2009 Strategic plan performance measure (Measure numbers are from the Strategic Plan, NIOSH Pub No. 2010-105)	Progress as of Dec 31, 2011
International Activities	4.2.4-1 Increase utilization of emerging information technology mechanisms (e.g., NIOSH science blog, web-based social networks, virtual reality).	NTRC nanotechnology team actively utilizes emerging information technology mechanisms to dissemination NIOSH products. For example, NIOSH nanotechnology topic page is regularly updated, and NTRC researchers post blogs on critical topics related to nanotechnology OH&S.
International Activities	4.2.4-2 Establish partnerships for translation of NIOSH publications to other languages.	US NIOSH worked with Italian NIOSH to translate and publish the US NIOSH nanotechnology brochure into Italian. NIOSH through its engagement with ISO, OECD and WHO pushes translation of its leading nanotechnology guidance documents into other languages. For example, Chinese NIOSH is translating NIOSH "Approaches to Safe Nanotechnology" into Mandarin.
International Activities	4.2.5-1 Strengthen participation in globally recognized organizations.	NTRC researcher leads projects in ISO and OECD. Most recently NIOSH also expanded its leadership in developing global nanotechnology workplace guidance documents in WHO and Inter-organizational Program for Sound Management of Chemicals.
International Activities	4.2.5-2 Expand partnerships to international bodies with economic instruments to implement OSH measures such as financial institutions (Inter-American Development Bank, World Bank) and insurance companies (Swiss Re, Munich Re, Lloyds)	No formal projects in place.



# Summary of the Citation Analysis

## APPENDIX F

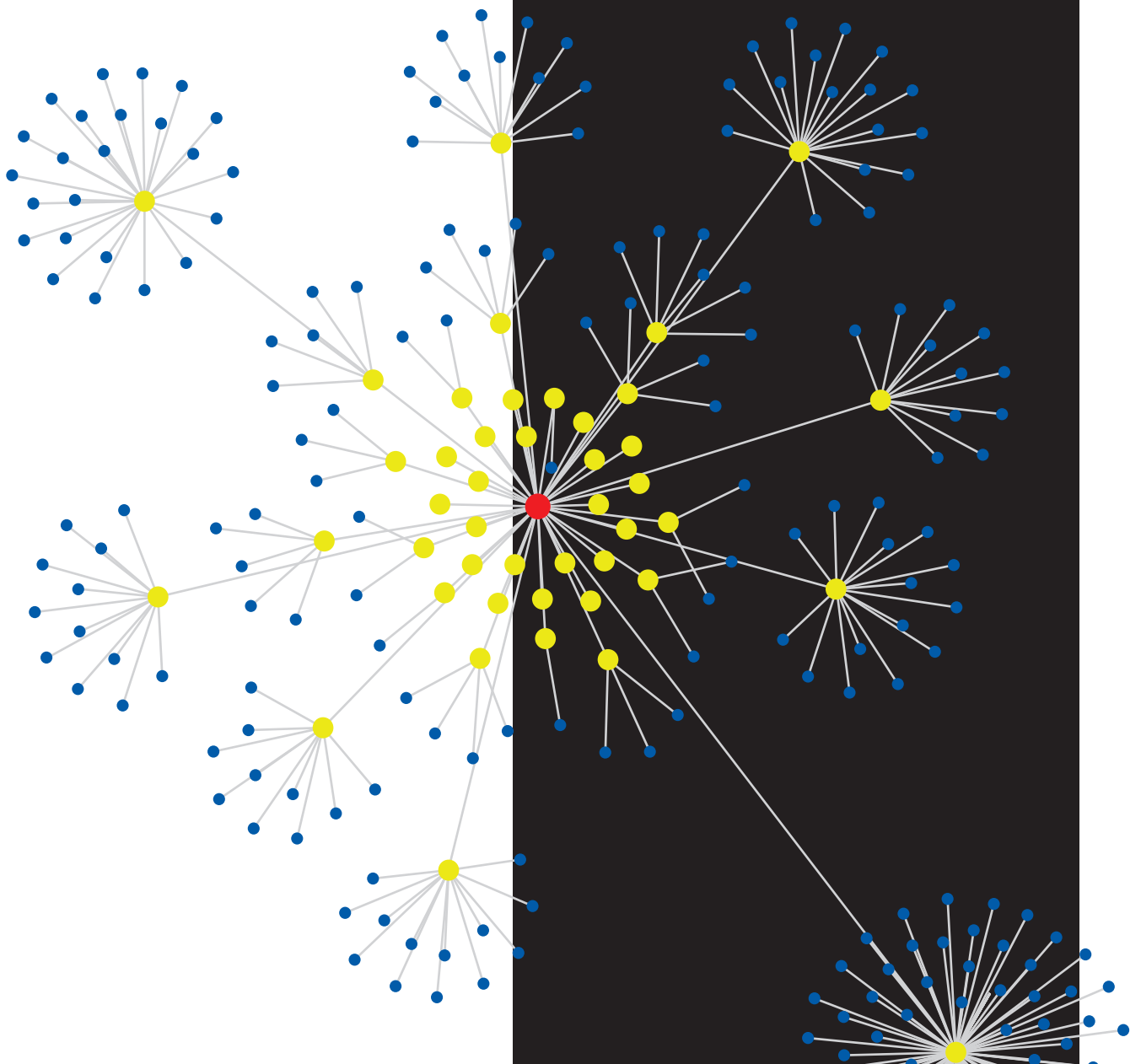



A Summary of the citation analysis as of December 31, 2011. Note that publications with no citations and those in *Toxicologist* are not included, as these are published as Society of Toxicology annual conference proceedings and are not searchable via Google Scholar or Web of Knowledge. NIOSH numbered publications are also not available for the citation analysis.

**Table F-1. Summary of the citation analysis.**

<b>Title</b>	<b>Authors</b>	<b>Year published</b>	<b>Citations (Google)</b>	<b>Secondary citations</b>
Iron oxide nanoparticles induce human microvascular endothelial cell permeability through reactive oxygen species production and microtubule remodeling	Apopa, Qian, Guo, Schwegler-Berry, Pacurari, Porter, Shi, Vallyathan, Castranova, Flynn	2009	32	96
Evaluating the toxicity of airborne particulate matter and nanoparticles by measuring oxidative stress potential—a workshop report and consensus statement	Ayres, Borm, Cassee, Castranova, Donaldson, Ghio, Harrison, Hider, Kelly, Kooter, Marano, Maynard, Mudway, Nel, Sioutas, Smith, Baeza-Squiban, Cho, Duggan, Froines	2008	51	459
Meeting report: hazard assessment for nanoparticles	Balbus, Maynard, Colvin, Castranova, Daston, Denison, Dreher, Goering, Goldberg, Kulinowski, Monteiro-Riviere, Oberdörster, Omenn, Pinkerton, Ramos, Rest, Sass, Silbergeld, Wong	2007	79	450
Aerosolization of single-walled carbon nanotubes for an inhalation study	Baron, Deye, Chen, Schwegler-Berry, Shvedova, Castranova	2008	15	191
Size shifts in measurements of droplets with the aerodynamic particle sizer and the aerosizer	Baron, Deye, Martinez, Jones, Bennett	2008	2	1
Toxicology of nanomaterials: permanent interactive learning	Borm, Castranova	2009	2	1
Overview of current toxicological knowledge of engineered nanoparticles	Castranova	2011	1	0
Nanoparticles-containing spray can aerosol: characterization, exposure assessment, and generator design	Chen, Afshari, Stone, Jackson, Schwegler-Berry, Frazer, Castranova, Thomas	2010	1	0

(continued)





**Table F-1 (Continued). Summary of the citation analysis.**

Title	Authors	Year published	Citations (Google)	Secondary citations
Exposure control strategies in the carbonaceous nano-material industry	Dahm, Yencken, Schubauer-Berigan	2011	3	0
An approach to risk assessment for TiO <sub>2</sub>	Dankovic, Kuempel, Wheeler	2007	18	88
The limits of testing particle-mediated oxidative stress <i>in vitro</i> in predicting diverse pathologies; relevance for testing of nanoparticles	Donaldson, Borm, Castranova, Gulumian	2009	19	61
Cross-talk between lung and systemic circulation during carbon nanotube respiratory exposure—potential biomarkers	Erdely, Hulderman, Salmen, Liston, Erdely, Schwegler-Berry, Castranova, Koyama, Kim Endo, Simeonova	2009	29	95
Ultrafine and respirable particles in an automotive grey iron foundry	Evans, Heitbrink, Slavin, Peters	2008	24	93
Aerosol characterization during carbon nanofiber production: mobile direct-reading sampling	Evans, Ku, Birch, Dunn	2010	3	2
There's plenty of room at the forum: potential risks and safety assessment of engineered nanomaterials	Fadeel, Kagan, Krug, Shvedova, Svartengren, Tran, Wiklund	2007	19	228
Deposition of inhaled nanoparticles in the rat nasal passages: dose to the olfactory region	Garcia, Kimbell	2009	2	0
Challenges in assessing nanoparticle toxicology: a personal perspective	Geraci, Castranova	2010	1	0
Particle length-dependent titanium dioxide nanomaterials' toxicity and bioactivity	Hamilton Jr., Wu, Porter, Buford, Wolfarth, Holian	2009	12	5

(continued)

**Table F-1 (Continued). Summary of the citation analysis.**

<b>Title</b>	<b>Authors</b>	<b>Year published</b>	<b>Citations (Google)</b>	<b>Secondary citations</b>
Relationships between particle number, surface area, and respirable mass concentration in automotive engine manufacturing	Heitbrink, Evans, Ku, Maynard, Slavin, Peters	2009	14	22
Characterization and mapping of very fine particles in an engine machining and assembly facility	Heitbrink, Evans, Peters, Slavin	2007	13	95
Exposure assessment considerations for nanoparticles in the workplace	Hoover, Stefaniak, Day, Geraci	2007	3	1
National nanotechnology partnership to protect workers	Howard, Murashov	2009	7	13
Persistent pulmonary inflammation, airway mucous metaplasia and migration of multi-walled carbon nanotubes from the lung after subchronic exposure	Hubbs, Mercer, Coad, Battelli, Willard, Sriram, Wolfarth, Castranova, Porter	2009	9	38
Potential for occupational exposure to engineered carbon-based nanomaterials in environmental laboratory studies	Johnson, Methner, Kennedy, Steevens	2010	16	12
Nanomedicine and nanotoxicology: two sides of the same coin	Kagan, Bayir, Shvedova	2005	88	558
Carbon nanotubes degraded by neutrophil myeloperoxidase induce less pulmonary inflammation	Kagan, Konduru, Feng, Allen, Conroy, Volkov, Vlasova, Belikova, Yanamala, Kapralov, Tyurina, Shi, Kisin, Murray, Franks, Stolz, Gou, Klein-Seetharaman, Fadeel, Star, Shvedova	2010	38	36
Direct and indirect effects of single-walled carbon nanotubes on RAW 264.7 macrophages: role in iron	Kagan, Potapovich, Osipov, Tyurina, Kisin, Schwegler-Berry, Mercer, Castranova, Shvedova	2006	189	3865

(continued)



**Table F-1 (Continued). Summary of the citation analysis.**

Title	Authors	Year published	Citations (Google)	Secondary citations
Comparison of the biological activity between ultrafine and fine titanium dioxide particles in RAW 264.7 cells associated with oxidative stress	Kang, Moon, Lee, Park, Kim, Castranova	2008	17	142
Optical-fiber-mounted porous silicon photonic crystals for sensing organic vapor breakthrough in activated carbon	King, Ruminski, Snyder, Sailor	2007	7	18
Pulmonary response, oxidative stress and genotoxicity Induced by carbon nanofibers	Kisin, Murray, Schwegler-Berry, Scabillon, Mercer, Chirila, Young, Leonard, Keohavong, Fadeel, Kagan, Castranova, Shvedova	2010	2	3
Phosphatidylserine targets single-walled carbon nanotubes to professional phagocytes <i>in vitro</i> and <i>in vivo</i>	Konduru, Tyurina, Feng, Basova, Belikova, Bayir, Clark, Rubin, Stolz, Vallhov, Scheynius, Witasch, Fadeel, Kichambare, Star, Kisin, Murray, Shvedova, Kagan	2009	14	115
In situ structure characterization of airborne carbon nanofibers by a tandem mobility-mass analysis	Ku, Emery, Maynard, Stolzenburg, McMurry	2006	17	184
Measurement of airborne carbon nanofiber structure using a tandem mobility-mass analysis	Ku, Emery, Maynard, Stolzenburg, McMurry	2006	17	184
Relation between electrical mobility, mass, and size for nanodrops 1–6.5 nm in diameter in air	Ku, Fernandez de la Mora	2009	24	162
Morphology of single-wall carbon nanotube aggregates generated by electrospray of aqueous suspensions	Ku, Kulkarni	2009	2	2

(continued)

**Table F-1 (Continued). Summary of the citation analysis.**

<b>Title</b>	<b>Authors</b>	<b>Year published</b>	<b>Citations (Google)</b>	<b>Secondary citations</b>
Comparing aerosol surface-area measurement of monodisperse ultrafine silver agglomerates using mobility analysis, transmission electron microscopy and diffusion charging	Ku, Maynard	2005	53	1324
Generation and investigation of airborne silver nanoparticles with specific size and morphology by homogeneous nucleation, coagulation, and sintering	Ku, Maynard	2006	27	292
Anomalous responses (arcing, electrical discharge) in a differential mobility analyzer caused by ultrafine fibrous carbon aerosols	Ku, Maynard, Baron, Deye	2005	10	33
Observation and measurement of anomalous responses in a differential mobility analyzer by ultrafine fibrous carbon aerosols	Ku, Maynard, Baron, Deye	2007	10	33
Risk assessment approaches and research needs for nanomaterials: an examination of data and information from current studies	Kuempel, Geraci, Schulte	2007	5	78
Rat- and human-based risk estimates of lung cancer from occupational exposure to poorly-soluble particles: a quantitative evaluation	Kuempel, Smith, Dankovic, Stayner	2009	2	0
Lung dosimetry and risk assessment of nanoparticles: evaluating and extending current models in rats and humans	Kuempel, Tran, Castranova, Bailer	2006	24	246

(continued)



**Table F-1 (Continued). Summary of the citation analysis.**

Title	Authors	Year published	Citations (Google)	Secondary citations
Quantitative risk assessment in workers using rodent dose-response data of fine and ultrafine titanium dioxide	Kuempel, Wheeler, Smith, Bailer	2005	5	44
Bipolar diffusion charging characteristics of airborne carbon nanotube aerosols	Kulkarni, Deye, Baron	2009	1	0
Nanoparticle inhalation impairs endothelium-dependent vasodilatation in subepicardial arterioles	LeBlanc , Cumpston, Chen, Frazer, Castranova, Nurkiewicz	2009	11	17
Nanoparticle inhalation impairs coronary microvascular reactivity via a local reactive oxygen species-dependent mechanism	LeBlanc, Moseley, Chen, Frazer, Castranova, Nurkiewicz	2010	10	7
Relationship of pulmonary exposure to multiple doses of single-wall carbon nanotubes and atherosclerosis in APOE <sup>-/-</sup> mouse model	Li, Chapman, Hulerman, Salmen, Shvedova, Luster, Simeonova	2006	2	65
Cardiovascular effects of pulmonary exposure to single-wall carbon nanotubes	Li, Hulderman, Salmen, Chapman, Leonard, Shvedova, Luster, Simeonova	2007	116	887
Pulmonary exposure to carbon nanotubes induces vascular toxicity	Li, Salmen, Hulderman, Kisin, Shvedova, Luster	2005	12	608
Pulmonary carbon nanotube exposure and oxidative status in vascular system	Li, Salmen, Hulderman, Kisin, Shvedova, Luster, Simeonova	2004	3	31
Cerium oxide, a diesel fuel catalyst, induces pulmonary fibrosis	Ma, Mercer, Rao, Barger, Meighan, Castranova, Ma	2010	2	0

(continued)

**Table F-1 (Continued). Summary of the citation analysis.**

<b>Title</b>	<b>Authors</b>	<b>Year published</b>	<b>Citations (Google)</b>	<b>Secondary citations</b>
Development of a bio-mathematical model in rats to describe clearance, retention and translocation of inhaled nano particles throughout the body	MacCalman, Tran, Kuempel	2009	2	6
Exposure to carbon nanotube material during the handling of unrefined single-walled carbon nanotube material	Maynard, Baron, Foley, Shvedova, Kisin, Castranova	2004	363	14587
Airborne nanostructured particles and occupational health	Maynard, Kuempel	2005	210	2449
Addressing the potential environmental and human health impact of engineered nanomaterials	Maynard, Kuempel	2006	1	2
Distribution and persistence of pleural penetrations by multi-walled carbon nanotubes	Mercer, Hubbs, Scabilloni, Wang, Castranova, Porter	2010	9	2
Use of labeled single-walled carbon nanotubes to study translocation from the lungs	Mercer, Scabilloni, Wang, Battelli, Castranova	2009	3	3
Alteration of deposition pattern and pulmonary response as a result of improved dispersion of aspirated single-walled carbon nanotubes in a mouse model	Mercer, Scabilloni, Wang, Kisin, Murray, Schwegler-Berry, Shvedova, Castranova	2008	74	893
Nanoparticle emission assessment technique (NEAT) for the identification and measurement of potential exposure to engineered nanomaterials—part B: results from 12 field studies	Methner, Hodson, Dames, Geraci	2010	17	8

(continued)



**Table F-1 (Continued). Summary of the citation analysis.**

<b>Title</b>	<b>Authors</b>	<b>Year published</b>	<b>Citations (Google)</b>	<b>Secondary citations</b>
Nanoparticle emission assessment technique (NEAT) for the identification and measurement of potential exposure to engineered nanomaterials—part A	Methner, Hodson, Geraci	2010	21	17
The fate of metal (Fe) during diesel combustion: morphology, chemistry, and formation pathways of nanoparticles	Miller, Ahlstr, Kittelson, Zachariah	2007	18	44
Real-time estimation of elemental carbon emitted from a diesel engine	Miller, Habjan, Park	2007	1	1
The nanoparticle information library (NIL): a prototype for linking and sharing emerging data	Miller, Hoover, Mitchell, Stapleton	2007	2	1
Role of lubrication oil in particulate emissions from a hydrogen-powered internal combustion engine	Miller, Stipe, Habjan, Ahlstr	2007	10	12
Pulmonary inflammation after intra peritoneal administration of ultrafine titanium dioxide (TiO <sub>2</sub> ) at rest or in lungs primed with lipopolysaccharide	Moon, Park, Choi, Park, Castranova, Kang	2010	1	2
Mechanisms of action of inhaled fibers, particles, and nanoparticles in lung and cardiovascular diseases	Mossman, Borm, Castranova, Costa, Donaldson, Kleeberger	2007	47	217
Occupational exposure to nanomedical applications	Murashov	2009	2	0
Occupational safety and health in nanotechnology and organisation for economic co-operation and development	Murashov, Engel, Savolainen, Fullam, Lee, Kearns	2009	10	3

(continued)



**Table F-1 (Continued). Summary of the citation analysis.**

Title	Authors	Year published	Citations (Google)	Secondary citations
Biosafety, occupational health, and nanotechnology	Murashov, Howard	2007	1	0
Essential features of proactive risk management	Murashov, Howard	2009	12	0
International standards for risk management in nanotechnology	Murashov, Howard	2009	1	5
Oxidative stress and inflammatory response in dermal toxicity of single-walled carbon nanotubes	Murray, Kisin, Leonard, Young, Kommineni, Kagan, Castranova, Shvedova	2009	51	179
Effects of sampling artifacts on occupational samples of diesel particulate matter	Noll, Birch	2008	4	6
Systemic microvascular dysfunction and inflammation after pulmonary particulate matter exposure	Nurkiewicz, Porter, Barger, Millecchia, Rao, Marvar, Hubbs, Castranova, Boegehold	2007	67	677
Nanoparticle inhalation augments particle-dependent systemic microvascular dysfunction	Nurkiewicz, Porter, Hubbs, Cumpston, Chen, Frazer, Castranova	2008	31	131
Inhalation of ultrafine titanium dioxide augments particle-dependent microvascular dysfunction	Nurkiewicz, Porter, Hubbs, Millecchia, Stone, Chen, Frazer, Castranova, Boegehold	2007	2	52
Pulmonary nanoparticle exposure disrupts systemic microvascular nitric oxide signaling	Nurkiewicz, Porter, Hubbs, Tone, Chen, Frazer, Boegehold, Castranova	2009	17	37
Principles for characterizing the potential human effects from exposure to nanomaterials: elements of screening strategy	Oberdorster, Maynard, Donaldson, Castranova, Fitzpatrick, Ausman, Carter, Karn, Kreyling, Lai, Olin, Monterio-Riviere, Warheit, Yang	2005	417	6462
Rapid measurements of aerosol size distributions using a fast integrated mobility spectrometer	Offert, Kulkarni, Wang	2008	10	18

(continued)



**Table F-1 (Continued). Summary of the citation analysis.**

Title	Authors	Year published	Citations (Google)	Secondary citations
Oxidative and molecular interactions of multi-wall carbon nanotubes (MWCNT) in normal and malignant human mesothelial cells	Pacurari, Yin, Ding, Leonard, Schwegler-Berry, Ducatman, Endo, Castranova, Vallyathan	2008	8	21
Raw single-wall carbon nanotubes induce oxidative stress and activate MAPKs, AP-1, NF-kB, and Akt in normal and malignant human mesothelial cells	Pacurari, Yin, Zhao, Ding, Leonard, Schwegler-Berry, Ducatman, Sbarra, Hoover, Castranova, Vallyathan	2008	62	353
Human health implications of nanomaterial exposure	Papp, Schiffmann, Weiss, Castranova, Vallyathan, Rahman	2008	14	82
A study on effects of size and structure on hygroscopicity of nanoparticles using a tandem differential mobility analyzer and transmission electron microscopy	Park, Kim, Miller	2008	6	18
The mapping of fine and ultrafine particle concentrations in an engine machining and assembly facility	Peters, Heitbrink, Evans, Slavin, Maynard	2006	47	462
Characterization of exposures to airborne nanoscale particles during friction stir welding of aluminum	Pfefferkorn, Bello, Haddad, Park Powell, McCarthy, Bunker, Fehrenbacher, Jeon, Gruetzmacher, Virji, Hoover	2010	1	0
Aerosol dosimetry research needs	Phalen, Hoover	2006	2	14
Engineered titanium dioxide nanowire toxicity <i>in vitro</i> and <i>in vivo</i>	Porter, Holian, Sriram, Wu, Wolfarth, Hamilton, Buford	2008	5	39
Mouse pulmonary dose- and time course-responses induced by exposure to multi-walled carbon nanotubes	Porter, Hubbs, Mercer, Wu, Wolfarth, Sriram, Leonard, Battelli, Schwegler-Berry, Friend, Andrew, Chen, Tsuruoka, Endo, Castranova	2010	33	46

(continued)

**Table F-1 (Continued). Summary of the citation analysis.**

<b>Title</b>	<b>Authors</b>	<b>Year published</b>	<b>Citations (Google)</b>	<b>Secondary citations</b>
A biocompatible medium for nanoparticle dispersion	Porter, Sriram, Wolfarth, Jefferson, Schwegler-Berry, Andrew, Castranova	2008	31	201
Total inward leakage of nanoparticles through filtering facepiece respirators	Rengasamy, Eimer	2011	1	0
Nanoparticle filtration performance of commercially available dust masks	Rengasamy, Eimer, Shaffer	2008	8	29
Comparison of nanoparticle filtration performance of NIOSH-approved and CE-marked particulate filtering facepiece respirators	Rengasamy, Eimer, Shaffer	2009	14	16
Filtration performance of NIOSH-approved N95 and P100 filtering facepiece respirators against 4-30 nanometer-size nanoparticles	Rengasamy, King, Eimer, Shaffer	2008	23	81
Evaluation of the filtration performance of NIOSH-approved N95 filtering facepiece respirators by photometric and number-based test methods	Rengasamy, Miller, Eimer	2011	1	0
Nanoparticle penetration through NIOSH-approved N95 filtering facepiece respirators	Rengasamy, Verfobsky, King, Shaffer	2007	18	138
Concepts of assessing nanoparticle hazards considering nanoparticle dose-metric and chemical/biological response-metrics	Rushton, Jiang, Leonard, Eberly, Castranova, Biswas, Elder, Han, Gelein, Finkelstein, Oberdorster	2010	18	26

(continued)



**Table F-1 (Continued). Summary of the citation analysis.**

Title	Authors	Year published	Citations (Google)	Secondary citations
Surface area of particle administered versus mass in determining the pulmonary toxicity of ultrafine and fine carbon black: comparison to ultrafine titanium dioxide	Sager, Castranova	2009	27	62
Pulmonary response to intratracheal instillation of ultrafine versus fine titanium dioxide: role of surface area	Sager, Kommineneni, Castranova	2008	37	159
An improved method to disperse nanoparticles for <i>in vitro</i> and <i>in vivo</i> investigation of toxicity	Sager, Porter, Robinson, Lindsley, Schwegler-Berry, Castranova	2007	74	1023
Potential pulmonary effects of engineered carbon nanotubes: <i>In vitro</i> genotoxic effects	Sargent, Reynolds, Castranova	2010	2	0
Induction of aneuploidy by single-walled carbon nanotubes	Sargent, Shvedova, Hubbs, Kashon, Salisbury, Lowry, Murray, Kisin, Friend, Benkovic, McKinstry, Battelli, Reynolds	2009	18	85
Engineered carbonaceous nanomaterials manufacturers in the United States: workforce size, characteristics and feasibility of epidemiologic studies	Schubauer-Berigan, Dahm, Yencken	2011	2	4
Nanotechnologies and nanomaterials in the occupational setting	Schulte, Geraci, Hodson, Zumwalde, Castranova, Kuempel, Methner, Hoover, Murashov	2010	1	1
Sharpening the focus on occupational safety and health of nanotechnology	Schulte, Geraci, Zumwalde, Hoover, Castranova, Kuempel, Murashov, Vainio, Savolainen	2008	5	17
Occupational risk management of engineered nanoparticles	Schulte, Geraci, Zumwalde, Hoover, Kuempel	2008	50	286

(continued)

**Table F-1 (Continued). Summary of the citation analysis.**

<b>Title</b>	<b>Authors</b>	<b>Year published</b>	<b>Citations (Google)</b>	<b>Secondary citations</b>
Occupational exposure limits for nanomaterials: state of the art	Schulte, Murashov, Zumwalde, Kuempel, Geraci	2010	11	5
Ethical and scientific issues of nanotechnology in the workplace	Schulte, Salamanca-Buentello	2007	60	136
Options for occupational health surveillance of workers potentially exposed to engineered nanoparticles: state of the science	Schulte, Trout, Zumwalde, Kuempel, Geraci, Castranova, Mundt, Mundt, Halperin	2008	19	41
Effects of titanium dioxide nanoparticle exposure on neuroimmune responses in rat airways	Scuri, Chen, Castranova, Reynolds, Samsell, Walton, Piedimonte.	2011	1	0
Respiratory protection against nanoparticles: A review	Shaffer, Rengasamy	2009	9	6
Exposure to carbon nanotube material: assessment of nanotube cytotoxicity using human keratinocyte cells	Shvedova, Castranova, Kisin, Schwegler-Berry, Murray, Gandelsman, Maynard, Baron	2003	505	16482
Sequential exposure to carbon nanotubes and bacteria enhances pulmonary inflammation and infectivity	Shvedova, Fabisiak, Kisin, Murray, Roberts, Tyurina, Antonini, Feng, Komminen, Reynolds, Barchowsky, Castranova, Kagan	2008	42	331
The role of nanotoxicology in realizing the 'helping without harm' paradigm of nanomedicine: lessons from studies of pulmonary effects of single-walled carbon nanotubes	Shvedova, Kagan	2010	14	16

(continued)



**Table F-1 (Continued). Summary of the citation analysis.**

Title	Authors	Year published	Citations (Google)	Secondary citations
Close encounters of the small kind: adverse effects of man-made materials interfacing with the nano-cosmos of biological systems	Shvedova, Kagan, Fadeel	2010	19	41
Unusual inflammatory and fibrogenic pulmonary responses to single-walled carbon nanotubes in mice	Shvedova, Kisin, Mercer, Murray, Johnson, Potapovich, Tyurina, Gorelik, Arepalli, Schwegler-Berry, Hubbs, Antonini, Evans, Ku, Ramsey, Maynard, Kagan, Castranova, Baron	2005	449	9777
Vitamin-E deficiency enhances pulmonary inflammatory response and oxidative stress induced by single-walled carbon nanotubes in C57BL/6 mice	Shvedova, Kisin, Murray, Gorelik, Arepalli, Castranova, Young, Gao, Tyurina, Oury, Kagan	2007	55	396
Inhalation versus aspiration of single-walled carbon nanotubes in C57BL/6 mice: inflammation, fibrosis, oxidative stress, and mutagenesis	Shvedova, Kisin, Murray, Johnson, Gorelik, Arepalli, Hubbs, Mercer, Keohavong, Sussman, Jin, Yin, Stone, Chen, Deye, Maynard, Castranova, Baron, Kagan	2008	101	738
Inhalation of carbon nanotubes induces oxidative stress and cytokine response causing respiratory impairment and pulmonary fibrosis in mice	Shvedova, Kisin, Murray, Johnson, Gorelik, Arepalli, Hubbs, Mercer, Stone, Frazer, Chen, Deye, Maynard, Baron, Mason, Kadiiska, Stadler, Mouithys-Mickalad, Castranova, Kagan	2008	2	2
Accumulation of neutrophils and decreased fibrosis in NADPH oxidase-deficient C57BL/6 mice exposed to carbon nanotubes	Shvedova, Kisin, Murray, Komminen, Castranova, Fadeel, Kagan	2008	21	115

(continued)

**Table F-1 (Continued). Summary of the citation analysis.**

<b>Title</b>	<b>Authors</b>	<b>Year published</b>	<b>Citations (Google)</b>	<b>Secondary citations</b>
Mechanisms of pulmonary toxicity and medical applications of carbon nanotubes: two faces of janus?	Shvedova, Kisin, Porter, Schulte, Kagan, Fadeel, Castranova	2009	58	249
Oxidative interactions of single-walled carbon nanotubes with RAW 264.7 macrophages: role of iron	Shvedova, Potapovich, Osipov, Tyurina, Kisin, Schwegler-Berry, Mercer, Castranova, Kagan	2006	189	3865
Critical issues in the evaluation of possible adverse pulmonary effects resulting from airborne nanoparticles	Shvedova, Sager, Murray, Kisin, Porter, Leonard, Schwegler-Berry, Robinson, Castranova	2007	14	338
Update on carbon nanotube toxicity	Simeonova	2009	6	5
Engineered nanoparticle respiratory exposure and potential risks for cardiovascular toxicity: predictive tests and biomarkers	Simeonova, Erdely	2009	9	23
Carbon nanotube exposure and risk for cardiovascular effects	Simeonova, Erdely, Li	2007	4	39
Carbon nanotube respiratory exposure and risk from systemic effects	Simeonova, Li, Erdely	2007	4	39
Nanotechnology: toxicological issues and environmental safety, NATO security through science series book	Simeonova, Luster	2007	3	16
Neuroinflammation and blood-brain barrier changes following exposure to engineered nanomaterials	Sriram, Porter, Jefferson, Lin, Wolfarth, Chen, McKinney, Frazer, Castranova	2009	3	3

(continued)





**Table F-1 (Continued). Summary of the citation analysis.**

Title	Authors	Year published	Citations (Google)	Secondary citations
Neuroinflammatory responses following exposure to engineered nanomaterials	Sriram, Porter, Tsuruoka, Endo, Jefferson, Wolfarth, Rogers, Castranova, Luster	2007	6	3
Medical surveillance, exposure registries, and epidemiologic research for workers exposed to nanomaterials	Trout, Schulte	2010	16	9
Potential <i>in vitro</i> effects of carbon nanotubes on human aortic endothelial cells	Walker, Li, Huiderman, Schwegler-Berry, Kashon, Simeonova	2009	13	65
Dispersion of single-walled carbon nanotubes by a natural lung surfactant for pulmonary <i>in vitro</i> and <i>in vivo</i> toxicity studies	Wang, Castranova, Mishra, Chen, Mercer, Schwegler-Berry, Rojanasakul	2010	3	0
Fibrous particle deposition in human and nasal passage: the influence of particle length, flow rate, and geometry of nasal airway	Wang, Hopke, Ahamadi, Cheng, Baron	2008	3	16
Direct fibrogenic effects of dispersed single-walled carbon nanotubes on human lung fibroblasts	Wang, Mercer, Rojanasakul, Qiu, Lu, Scabilloni, Wu, Castranova	2010	13	48
Shape-enhanced photocatalytic activity of anatase TiO <sub>2</sub> (101) nanobelts	Wang, Tafen, Zheng, Lewis, Leonard, Manivannan, Wu	2010	28	10
Single-walled carbon nanotubes impair human macrophage engulfment of apoptotic cell corpses	Witasp, Shvedova, Kagan, Fadeel	2009	6	53
Understanding workplace processes and factors that determine exposure to nanomaterials	Woskie, Bello, Virji, Stefaniak	2010	2	1

(continued)

**Table F-1 (Continued). Summary of the citation analysis.**

<b>Title</b>	<b>Authors</b>	<b>Year published</b>	<b>Citations (Google)</b>	<b>Secondary citations</b>
Decreased dissolution of ZnO by iron doping yields nanoparticles with reduced toxicity in the rodent lung and zebrafish embryos	Xia, Zhao, Sager, George, Pokhrel, Li, Schoenfield, Meng, Lin, Wang, Wang, Ji, Zink, Madler, Castranova, Lin, Nel	2011	3	5
<b>SUMMARY</b>			<b>5,135</b>	<b>82,512</b>



***Delivering on the Nation's promise:  
safety and health at work for all people  
through research and prevention***

To receive NIOSH documents or more information about occupational safety and health topics, contact NIOSH:

**1-800-CDC-INFO** (1-800-232-4636)  
TTY: 1-888-232-6348  
E-mail: [cdcinfo@cdc.gov](mailto:cdcinfo@cdc.gov)

or visit the NIOSH Web site at <http://www.cdc.gov/niosh>.

For a monthly update on news at NIOSH, subscribe to *NIOSH eNews* by visiting [www.cdc.gov/niosh/eNews](http://www.cdc.gov/niosh/eNews).

**DHHS (NIOSH) Publication No. 2013-101**

**SAFER • HEALTHIER • PEOPLE™**