

INDUSTRIAL NOISE CONTROL MANUAL

Vincent Salmon
James S. Mills
Andrew C. Petersen .

Industrial Noise Services, Inc.
Palo Alto, California

Contract No. HSM 99-73-82

U. S. DEPARTMENT OF HEALTH, EDUCATION, AND WELFARE
Public Health Service
Center for Disease Control
National Institute for Occupational Safety and Health
Division of Laboratories and Criteria Development
Cincinnati, Ohio 45202
June 1975

The contents of this report are reproduced herein as received from the contractor except for minor changes. The opinions, findings, and conclusions expressed are those of the authors and not necessarily those of NIOSH. Mention of company or product names is not to be considered as an endorsement by NIOSH.

DHEW Publication No. (NIOSH) 75-183

NIOSH Project Officer: Roy M. Fleming

BIBLIOGRAPHIC DATA SHEET		1. Report No. NIOSH-75-183	2.	3. Recipient's Accession No. PB276812
4. Title and Subtitle INDUSTRIAL NOISE CONTROL MANUAL			5. Report Date June 1975	6.
7. Author(s) Vincent Salmon, James S. Mills, and Andrew C. Petersen			8. Performing Organization Rept. No.	
9. Performing Organization Name and Address Industrial Noise Services, Inc. Palo Alto, California			10. Project/Task/Work Unit No.	
			11. Contract/Grant No. HSM-99-73-82	
12. Sponsoring Organization Name and Address National Institute for Occupational Safety and Health 4676 Columbia Parkway Cincinnati, Ohio 45226			13. Type of Report & Period Covered	
			14.	
15. Supplementary Notes				
16. Abstracts This manual contains fundamental information to aid the user in understanding, measuring, and controlling noise. It was written for persons having little or no experience in solving noise control problems, realizing that a large number of businesses are not prepared to deal with their noise problems effectively. There are seven chapters in the manual covering the following subjects: fundamental principals of sound, noise measurement, noise control techniques, noise control materials, case histories of successful applications of noise control methods in actual industrial situations, how to choose a qualified consultant, and references to additional pertinent literature. The manual should be used as a guide to help the reader develop solutions to his particular noise problems using proven methods.				
17. Key Words and Document Analysis. 17a. Descriptors Industrial hygiene Acoustic measurement Noise reduction Industrial plants Noise analyzers Noise generators Sound level meters Acoustic insulation Acoustic screening Control equipment 17b. Identifiers/Open-Ended Terms				
17c. COSATI Field/Group 06/J				
18. Availability Statement Release unlimited			19. Security Class (This Report) UNCLASSIFIED	es
			20. Security Class (This Page) UNCLASSIFIED	22. Price PC-A18/ME-AD1

ABSTRACT

This manual contains fundamental information to aid the user in understanding, measuring, and controlling noise. It was written for persons having little or no experience in solving noise control problems, realizing that a large number of businesses are not prepared to deal with their noise problems effectively. There are seven chapters in the manual covering the following subjects: fundamental principles of sound, noise measurement, noise control techniques, noise control materials, case histories of successful applications of noise control methods in actual industrial situations, how to choose a qualified consultant, and references to additional pertinent literature. The manual should be used as a guide to help the reader develop solutions to his particular noise problems using proven methods.

FOREWORD

Following passage of the Occupational Safety and Health Act of 1970, the United States Department of Labor established a workplace noise exposure regulation which affects the majority of businesses having excessively noisy environments. Many companies may not be prepared to deal with their noise problems effectively but are trying to implement noise reduction programs nonetheless. Company personnel can be faced with uncertainty when attempting to choose a noise control method or device, noise control materials, noise measuring instrumentation, or a qualified consultant. Industries need practical noise control advice which draws upon the successes and failures of previously tested methods in order to reduce the time and expense involved in achieving an acceptable noise environment.

Accordingly, a contract was awarded for the development of a manual which would provide essential information for understanding noise control techniques, including a large number of noise control case histories from actual industrial situations. Several excellent reference books have been available for many years, but none have stressed case histories sufficiently. (However, during the term of this contract, at least two noise control books were published which do contain useful case histories; these are included in the list of references.) It was decided that this manual, in particular, should present sufficient practical information to provide the user with a solid foundation for understanding, measuring, and controlling noise. For readers desiring additional information, the manual would give references which cover areas of interest in greater detail.

It was recognized that noise control is not a new discipline, and that many effective noise control programs have been instituted by industry, both on an in-house basis and by hiring qualified noise control consultants. A wide range of noise problems and control solutions needed to be compiled from many industrial programs in order for this manual to benefit a large number of companies. Each case history necessarily would contain sufficient detail to guide the reader in using the method to solve the same or a similar noise problem. A minimum of thirty varied case histories was specified to the contractor. Although the coverage provided by the case histories documented in the manual is not as broad as was anticipated, it is hoped that subsequent publications of additional case histories can

be made available to expand this important chapter of the manual. A free exchange of mutually beneficial information can aid many companies in solving their noise problems effectively.

In planning for future supplemental sections to the case history chapter of this manual, we invite all interested parties to submit case histories of solutions to industrial noise problems. No case histories will be published without giving acknowledgement to each contributor who so desires; and case histories will be revised, if necessary, to fit the general format listed below. The time of publication for any supplement would, of course, be dependent upon the amount of response to this invitation.

Case History Format:

- A. Description of the process, machine, and noise problem.
- B. Noise measurements made and discussion of findings.
- C. Control approaches -- advantages and disadvantages.
- D. Results in terms of noise reduction achieved and cost.
- E. Pitfalls to avoid in implementing the control methods.
- F. Figures -- noise data (e.g., octave band levels).
- G. Sketches of area layout, machine-operator relationship, construction details of noise control devices.
- H. Photographs of machines before and after modifications -- 8 x 10 glossy preferred.

Case Histories can be sent to:

Noise Section/Physical Agents Branch
Division of Laboratories and Criteria Development
National Institute for Occupational Safety and Health
532 U.S. Post Office and Courthouse
Cincinnati, Ohio 45202

CONTENTS

LIST OF ILLUSTRATIONS	xi
LIST OF TABLES	xv
CHAPTER 1 FUNDAMENTALS OF SOUND	1
Basic Principles	1
Definitions and Relationships	2
Hearing and Noise Level Weighted Scales	5
Combining Noise Levels	8
Noise Generation and Noise Fields	10
Sound Power	13
Summary of Symbols and Definitions	14
CHAPTER 2 MEASUREMENT OF NOISE	15
Compliance Measurements	15
Basic Instruments, Use and Calibration	15
Dosimeters	19
Diagnostic Measurements	19
Sound Level Meters	19
Octave Band Filters	24
Fractional Octave-Band Analyzers	24
Photographic Equipment	24
Tape Recorders	25
Other Equipment	26
Making Readings	27
Relating to A-levels	27
Vibration	28
Ears and Mind	28
General Tips	29
Combining Decibels	29
Data Requirements	30
Follow-Up Measurements	32
CHAPTER 3 NOISE CONTROL TECHNIQUES	33
Source	33
Distance or Relocation	34
Vibration Control or Isolation	34
Damping	36
Lagging	37
Air and Gas Flow Noise Reduction	38
Air Jet Flow	39

Hydraulic Systems	39
Motor Air Noise	42
Enclosed Drives	42
Balancing	42
Noise Source Enclosures or Barriers	43
Path of Sound	43
Acoustical Shields and Barriers	43
Total Enclosure	46
Room Acoustics	57
Receiver	60
Administrative Controls	60
Personal Protective Equipment	61
Audiometry	62
CHAPTER 4 NOISE CONTROL MATERIALS	63
Absorption Materials	63
Transmission Loss Materials	65
Damping Materials	66
Vibration Isolators	67
Material Selection	67
Acoustic Considerations	67
Vibration Isolators	71
Silencers	72
Nonacoustic Considerations of Materials	72
CHAPTER 5 CASE HISTORIES	75
Case History Data	75
Outline of Complete Procedure for Development of Noise Control	75
1 - Steel Wire Fabric Machine	81
2 - 800-Ton Verson Blanking Press - Vibration Isolation	88
3 - Blood Plasma Centrifuge	95
4 - Blanking Press Ram	111
5 - Spinning Frame Air Noise	116
6 - Barley Mill	119
7 - Sheeter for Boxboard	129
8 - Air Scrap Handling From Bobst Cutting Presses, Folding Carton Manufacturing	133
9 - Jordans for Paper Mill for Boxboard	136
10 - Folding Carton Packing Stations, Air Hammer Noise Source	142
11 - In-Line Gravure Printing and Cutting Press Folding Cartons	146
12 - Air Scrap Handling Ducts for Corrugated Container Industry	149
13 - Paper Machine, Wet End	152

14 - Punch Press Noise	157
15 - Straight and Cut Machines	170
16 - Cut-Punch Press in Metal Fabricating Plant	177
17 - Parts Conveying Chute	184
18 - Nail Making Machine	187
19 - Wood Planer	191
20 - Punch Press	196
21 - Materials Handling, Air Motors	205
22 - Textile Braiding Machines	207
23 - Metal Cut-Off Saw	210
24 - Planer-Wood	213
25 - Punch Press Total Enclosure	215
26 - Dewatering Vacuum Pump, Paper Mill	216
27 - Steam Line Regulators	218
28 - Plastics Scrap Grinder	220
29 - Newspaper Printing Press	223
30 - Chemical Process Plants	224
 CHAPTER 6 SELECTING AND USING A CONSULTANT	 231
Knowing When a Consultant is Needed	231
Selection of a Consultant	232
Guideline Questions	233
The Proposal	236
Other Services	238
 CHAPTER 7 ANNOTATED REFERENCES	 239

ILLUSTRATIONS

1.1	Frequency-wavelength chart	3
1.2	Response characteristics of weighting scales and of ear at threshold	6
1.3	Method for combining decibel levels	9
1.4	Noise field around a single machine	12
3.1	Effect of reduced pump speed on noise level	40
3.2	Side branch muffler	41
3.3	Dissipative muffler	41
3.4	Source-barrier-receiver geometry	45
3.5	Split panels for services	47
3.6	Welded angle iron frame	48
3.7	Enclosure panels secured to frame by quarter-turn fasteners	48
3.8	Vibration isolation and toe coving	49
3.9	Enclosure panel interior treatment	50
3.10	Door and hatch detail	51
3.11	Window detail	51
3.12	Cooling and ventilation system	52
3.13	Examples of partial and complete enclosures	53
3.14	Effect of enclosure sound leaks on potential noise reduction	54
3.15	Example of isolating wall	56
3.16	Sound field behavior in a reverberant room	58
4.1	Transmission loss plateaus	69
4.2	The mass law relation between average sound transmission loss and mass per unit area of partition	70
5.1.1	Noise levels for 8-foot fabric machine, 1 meter from main drive gear	83
5.1.2	Noise levels for 8-foot fabric machine operator station	84
5.1.3	Noise levels for 8-foot fabric machine 1 meter behind operator station in wire spool area	85
5.1.4	Steel plate barrier with window	86
5.1.5	Lexan barrier in two sections	87
5.2.1	Vertical acceleration on pier, before and after isolation	90
5.2.2	Horizontal acceleration on pier, before and after isolation	91
5.2.3	Attenuation of vertical and horizontal acceleration at pier by adding isolation	92
5.2.4	Quasi-peak levels 4 feet from press foot, before and after isolation	93
5.2.5	A-weighted quasi-peak levels 4 feet from press, before and after isolation	95

5.3.1	Sketch of one centrifuge	98
5.3.2	Operator exposure in -5°C box room	99
5.3.3	Sketch of centrifuge showing locations for close-in diagnostic readings	100
5.3.4	Centrifuge noise measured parallel to motor shaft	101
5.3.5	Centrifuge noise measured 15 cm directly below pulley	102
5.3.6	Centrifuge noise measured perpendicular to spout	103
5.3.7	Centrifuge noise measured between centrifuge motor and pulley belt	104
5.3.8	Centrifuge noise measured 2 cm from centrifuge motor exhaust	105
5.3.9	Centrifuge noise measured at tub height	106
5.3.10	Operator's exposure in reconstituting room	107
5.3.11	Noise in reconstituting room, measured 2 cm from bottom edge of exhaust face of refrigeration unit	108
5.3.12	Noise in reconstituting room, measured 2 cm below rear intake face of refrigeration unit	109
5.3.13	Motor exhaust muffler	110
5.4.1	Method used to cover slots in blanking press ram	113
5.4.2	Quasi-peak readings of blanking press before noise control	114
5.4.3	Quasi-peak readings of blanking press after ram ringing was contained	115
5.5.1	Air exhaust vent modification for spinning machine noise control	118
5.6.1	Barley mill noise levels, measured between Moorspeed and Ross mills	124
5.6.2	Barley mill noise levels, measured at guard rail of hay shredder	125
5.6.3	Barley mill noise levels, measured at control operator chair	126
5.6.4	Floor plan of barley mill	127
5.6.5	Sectional view of barley mill	128
5.7.1	Floorplan of sheeter for boxboard	131
5.7.2	Sheeter drive box enclosure	131
5.7.3	Layout of sheeter and operators	132
5.8.1	Scrap handling system for cutting press	135
5.9.1	Noise levels 1 m from Jordan refiner	139
5.9.2	Noise levels inside enclosure of control room for Jordans	140
5.9.3	Noise reduction lagging for Jordan shell	141

5.10.1	Air hammer stripper and packer line	144
5.10.2	Barrier wall theory	145
5.11.1	Top view of in-line gravure-cut press with sound barrier curtain	148
5.11.2	Side view of in-line gravure-cut press with sound barrier curtain	148
5.12.1	Noise levels in scrap duct for corrugated box industry, before and after covering	151
5.13.1	Noise levels at wet end aisle of paper machine	154
5.13.2	Paper mill--wet end	155
5.13.3	Noise levels inside control booth at wet end of paper machine	156
5.14.1	Layout of punch press room	160
5.14.2	Ambient noise level with furnace and punch presses off	161
5.14.3	Ambient noise level with furnace on, punch presses off	162
5.14.4	Ambient noise level with furnace on, two Summit, two Bliss, and one Benchmaster presses in operation	163
5.14.5	Operator's exposure at punch I: stamping stock	164
5.14.6	Operator's exposure at punch I: stamping without stock	165
5.14.7	Operator's exposure at punch VII	166
5.14.8	Operator's exposure at punch VII, operating without work piece	167
5.14.9	Operator's exposure at punch VII, operating without stock and without air exhaust	168
5.14.10	Design of nozzle	169
5.14.11	Sketch of Plexiglas barrier	169
5.15.1	Straight and cut machine: close-in measure near west side of clutch cutter mechanism	172
5.15.2	Straight and cut machine: close-in measure near east side of clutch cutter mechanism	173
5.15.3	Straight and cut machine: operator's near field exposure	174
5.15.4	Straight and cut machine: operator's far field exposure	175
5.15.5	Barrier wall for straight and cut machine	176
5.16.1	Cut-punch press, operator's exposure	179
5.16.2	Cut-punch press, close-in diagnostic data, 14 cm from gears	180
5.16.3	Cut-punch press, close-in diagnostic data, 5 cm from the dog-flywheel interface	181

5.16.4	Cut-punch press, close-in diagnostic data, 5 cm from piston-collar impact on air cylinder	182
5.16.5	Sketch of hanging barrier for cut-punch press	183
5.17.1	Chute for conveying cartridge cases	185
5.17.2	Noise spectra measured 3 feet from chute	186
5.18.1	Nail making machine: operator position noise levels	189
5.18.2	Nail making machine: operator position noise levels after vibration isolators installed	190
5.19.1	Noise levels for wood planer - straight cutter	193
5.19.2	Noise levels for wood planer with helical cutter	194
5.19.3	Effect of board length on noise from wood planer	195
5.20.1	Comparison of punch press noise levels with air ejection and with mechanical ejection	200
5.20.2	Comparison of punch press noise levels with and without a shield between operator and air ejection noise	201
5.20.3	Comparison of punch press noise levels: standard die versus slanted die	202
5.20.4	Noise levels 30 feet from bench press area, before and after sound absorption treatment	203
5.20.5	Noise 30 inches from punch press, before and after test cardboard enclosure	204
5.21.1	Effect of muffler on air exhaust from hoist	206
5.22.1	Textile braiding machine: comparison of noise levels from steel carriers and from polyurethane carriers	209
5.23.1	Metal cut-off saw: operator's exposure, before and after enclosure of saw	212
5.26.1	Octave-band analysis of paper mill vacuum pump noise	217
5.27.1	Main valve plug with throttling vanes to reduce noise in steam line regulator	219
5.28.1	Plastics grinder; range of noise levels, dBA	221
5.28.2	Plastics grinder; range of noise levels after soundproofing, dBA	222
5.30.1	Noise reduction achieved by reducing fan speed, using increased blade pitch to offset decrease in speed	225
5.30.2	Compressor discharge noise reduction achieved by lagging expansion joint	226
5.30.3	Noise reduction achieved by redesigning pump by-pass loop	227
5.30.4	Noise reduction achieved by adding silencer to air blower intake	228

TABLES

1.1	Corrections from flat levels to A-levels	7
1.2	Method for approximating decibel combinations	9
1.3	Example of level combining	10
2.1	Sound level meters and accessories available	21
3.1	Required static deflection for common industrial speeds or forcing frequencies	35
3.2	A-level noise reduction by use of heavier pipe	42
4.1	Sound absorption coefficients of common acoustic materials	64
4.2	Sound absorption coefficients of common construction materials	64
4.3	Transmission loss of common materials	68
5.30.1	Sources of noise and methods of noise reduction	229

Chapter 1

FUNDAMENTALS OF SOUND

The need for noise control is certainly not new; the ancient Romans complained about chariot noise. But as the industrial revolution progressed, noise has become more intense and more persistent. Machinery to do specific jobs was designed, manufactured and sold to its users without much, if any, concern for noise. Recently, both State and Federal Governments have become active in dealing with environmental pollution of all kinds, of which noise is a part. Thus, there is a new emphasis on reduction of noise at its source.

When faced with the problem of high or unacceptable noise levels, you must be able to make a choice of the many different ways of achieving reduction of these levels. In some cases you will be able to apply more or less standard solutions that can be found in the literature about your particular industry or machine. However, the general problem of noise reduction is not so simple. Rather than applying a standard recipe, you must learn and apply the first principles of sound and vibration to the problem and design the noise reduction means yourself. This chapter is designed to introduce you to these basic principles so that you can apply them.

Basic Principles

Sound is transmitted through any elastic medium (gas, solid, or liquid) and propagates as wave motion. A convenient way to visualize wave motion is to use a long spring, such as a "Slinky" toy. If such a spring is stretched vertically and the top is quickly lowered, a motion down the length of the spring will result. The bunching together and spreading apart of the individual spring elements is a wavelike motion. These motions help us to visualize and thus understand wave motion.

The visual wave motion of the spring corresponds to the invisible wave motion of sound waves. Actually, sound propagates by elastic interactions among atomic or molecular components of the medium through which it travels. This means that the speed of sound depends on the mass of the molecules (density) and on their elastic reactions (pressure).

To discuss the properties of wave motion, let us return to the coil spring example. Again, stretch the spring vertically and then suddenly push down on the top coils, but this time continue to repeat this motion. You will see groupings of compressed coils traveling down the spring. Between these compressed coil groupings will be groupings whose coils are expanded farther apart than usual. Of course, the coils do not move down; they stay in one average position and oscillate about it. What moves in the wave motion is the grouping of spring elements. This motion of the grouping of elements travels with a definite speed. If you change the rate of up and down motion of your hand holding the top of the spring, the speed of the groups will stay the same, but the spacing between groups will change. This spacing is called the wavelength.

The wave speed in the spring remains constant while the wavelength of the groupings changes. The same situation occurs with sound in the air. Airborne sound travels at a speed (c) of 344 meters/second at 20°C (which is 1127 feet/second at 68°F). The wave motion in air involves particles (atoms and molecules) that vibrate because of the sound energy present. The number of complete cycles per second executed by these particles is called the frequency of the wave. In our spring analogy, we noticed that we could change the frequency or wavelength, the sound speed remaining unchanged.

Definitions and Relationships

We are basically interested in four parameters descriptive of sound waves in air: sound speed, frequency, wavelength, and amplitude. The sound speed depends on the temperature of the medium, while amplitude depends on both temperature and density.

In many noise control problems you will be concerned with both frequency and wavelength. In modern terminology, the unit of frequency is cycles per second or hertz, abbreviated Hz. The symbol for frequency is f .

Wavelength is the distance between similar configurations or groupings of molecules in the sound wave. The Greek letter lambda (λ) is the symbol for wavelength. From the coil spring experiment it can be noted that the spacing between groups decreased as the frequency of starting motion was increased. In more precise form, we relate sound speed, frequency, and wavelength by the formula

$$c = f \lambda. \qquad (1.1)$$

Figure 1.1 shows this relation for sound in air at 68°F. At 1000 Hz the wavelength is about 1.1 ft, 13.5 in., or 34 cm. In Chapter 3 we shall discuss how these concepts are used in noise control technology.

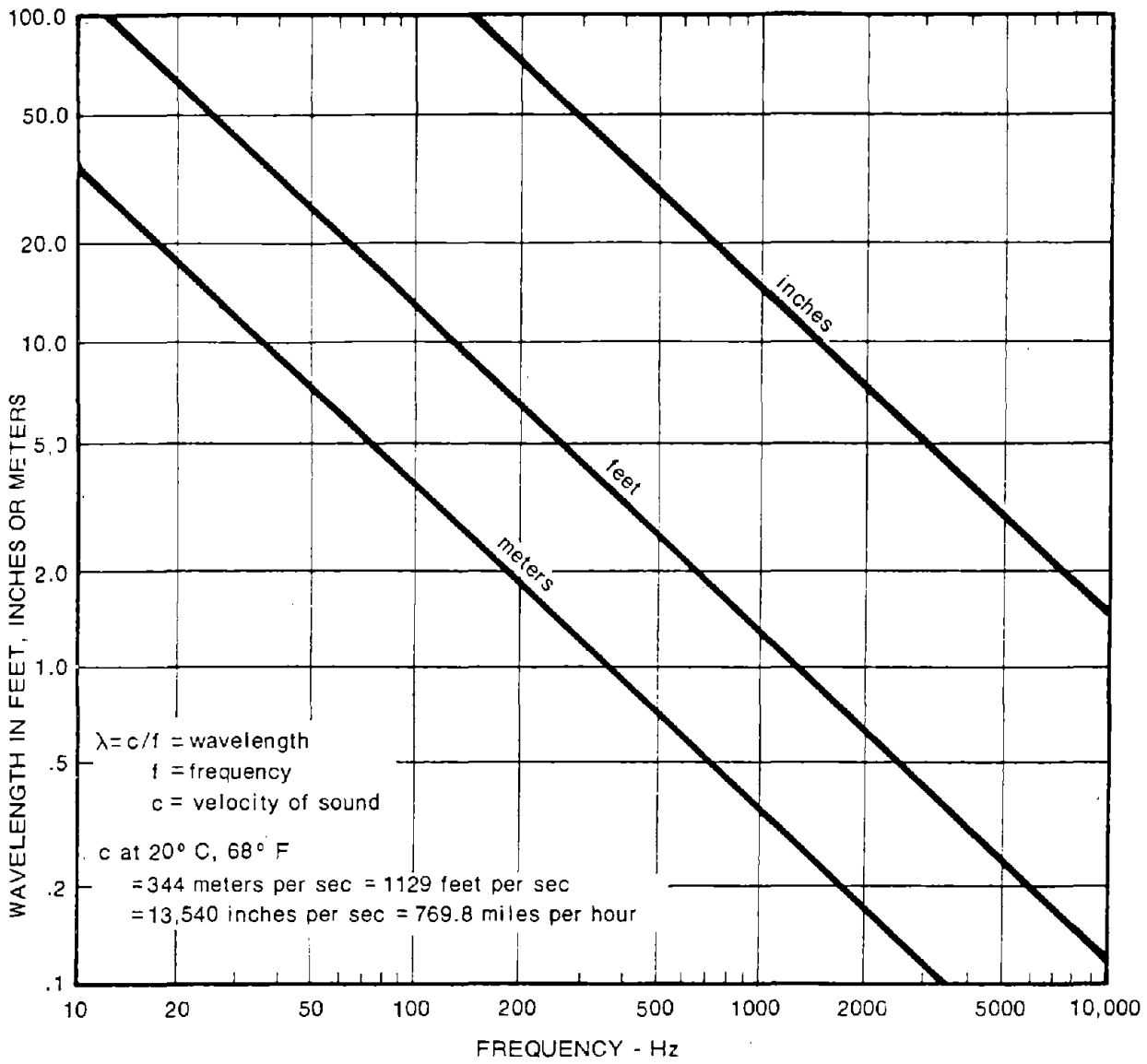

FIGURE 1.1 - Frequency - wavelength chart

Airborne sound is typically what we are involved with in industrial noise problems, and the two parameters of most concern are frequency and amplitude. The amplitude, or magnitude, of a noise cannot be described easily without an explanation of some of the basic physics of sound. The perception of amplitude, called loudness, and the measurement of amplitude are related to this understanding.

Sound has traditionally been measured by observing its effect on something. Early methods used diaphragms and direct recorders that were displaced by sound waves alone, much as is the eardrum. Scientists were able to calculate the amount of sound pressure

required to produce displacements. However, simple and reliable quantitative measurements were not possible until stable microphones and amplifiers were developed. The term "sound pressure" describes the alternating pressure above and below atmospheric pressure. The magnitude of the pressure fluctuations can be sensed by noting that a fluctuation of only 0.1% of atmospheric pressure represents an intolerably loud sound. Mathematical descriptions of these pressure fluctuations are not as important here as are the concepts of the physical motion and the definitions of sound pressure, sound power, and sound pressure level. The relationships between these terms is somewhat complicated, but the following discussion will provide an introduction.

The equation relating sound power to sound pressure (for plane and spherical waves) is

$$W = p^2 S / \rho c \quad (1.2)$$

where W is the sound power, p is the sound pressure, S is the surface area associated with the measured sound pressure, ρ is the greek letter "rho" used for density of the medium, and c is the speed of sound. For noise control in which spherical waves are encountered, $S = 4\pi r^2$, where $\pi = 3.1416$ and r is the distance from source to measurement point.

The sound pressure, p , could be measured to indicate the magnitude of a sound, but the range of values between a high and low sound pressure could easily have a ratio of a million-to-one. To eliminate the problem of this wide numerical range, "sound pressure level" (L_p) is used. The logarithmic relationship between sound pressure level and sound pressure is defined by the equation.

$$L_p = 10 \log_{10} (p^2/p_0^2) = 20 \log_{10} (p/p_0) \quad (1.3)$$

where p_0 is a reference pressure. The reference pressure has been chosen to be a value which is approximately the threshold of hearing at 1.000 cycles per second (0.0002 dyne/cm², 20 micrometer/m², or 20 microPa). The unit of sound pressure level is the "decibel" (dB), so that if $p = p_0$, then $L_p = 0$ dB. From the definition of reference pressure, it follows that a person with excellent hearing could hear sounds levels at least as low as 0 dB.

Experiments have developed the approximate relation between loudness and sound level. For levels around that of conversational speech, the sensation change that is described as "twice as loud" corresponds to a change in level of 8 to 10 dB. Thus, sound at 60 dB would feel about twice as loud as sound at 50 dB; and at 90 dB, half as loud as 100 dB.

The sensation of pitch is well-correlated with frequency. The musical interval called the "octave" is recognized by most people. It corresponds to a frequency ratio of two to one. Thus, middle C, at 262 Hz, is an octave above 131 Hz and an octave below 524 Hz. Often you will need to estimate the frequency of such machinery

sounds as those from fan blades and gear teeth. Remember that you need the number of events per second, whereas rpm is usually given. For example, if a large air-moving centrifugal fan has 24 blades and operates at 1165 rpm, the fan blade passage frequency is $(1165)(24)/60 = 466$ Hz. This tone should be audible to the ear. With practice, you can learn to listen for such definite tones in the presence of other components of the noise.

Quality refers to that aspect of sound that enables us to distinguish between two similar sounds. The physical equivalent of quality is the character of the spectrum. The spectrum is an objective and precise numerical statement of how much of the total sound exists in all frequency regions, from low to high. Spectra are measured with electrical filters that pick out and pass only the frequency regions for which they are designed. The one in most common use by the noise control engineer is the octave band filter, which is discussed in Chapter 2. With this, the resulting spectrum gives the sound levels in each octave band, usually 63 through 8000 Hz.

Hearing and Noise Level Weighted Scales

The whole human hearing system, which we refer to as the ear, can receive and interpret a wide variety of sounds. When sound of only one frequency is present, and the sound pressure variation with time is sinusoidal, the sound is said to be a pure tone. Complex sounds, such as the usual noise spectrum, may be considered to be made up of a multiplicity of random phase pure tones.

We have seen that the ear is capable of sensing very small amounts of sound energy. Figure 1.2 shows the relationship between excellent hearing and the response of the weighting circuits in standard sound level meters.

The combination of noise levels and the exposure time to such levels is called noise exposure. (Noise exposure calculation is explained in Chapter 2.) The spectrum of noise is also important, as can be seen from examination of Figure 1.2. The ear is much more sensitive to components with frequencies above 1000 Hz, and is much more easily damaged by noise of high intensity at, say, 3000 Hz than at 300 Hz. Instead of dealing with the many frequencies in the hearing range, it would be convenient to be able to use a single number descriptive of the noise spectrum character, to simplify the measurement and evaluation of noise.

Botsford, Young, and others have successfully demonstrated the value of this single number approach. It turns out that A-scale readings of noise show reasonably acceptable correlation with the potential for causing hearing loss. At the same time, some simple indicator of spectrum character is needed. Botsford takes the difference between the A-weighted or A-scale noise and the C-weighted or C-scale noise levels measured on a standard sound level meter. Reexamination of Figure 1.2 shows that the C-weighted noise includes more of the lower frequencies than does the A-weighted. Thus, if we consider the following three possibilities, we can see what is meant about quality of noise.

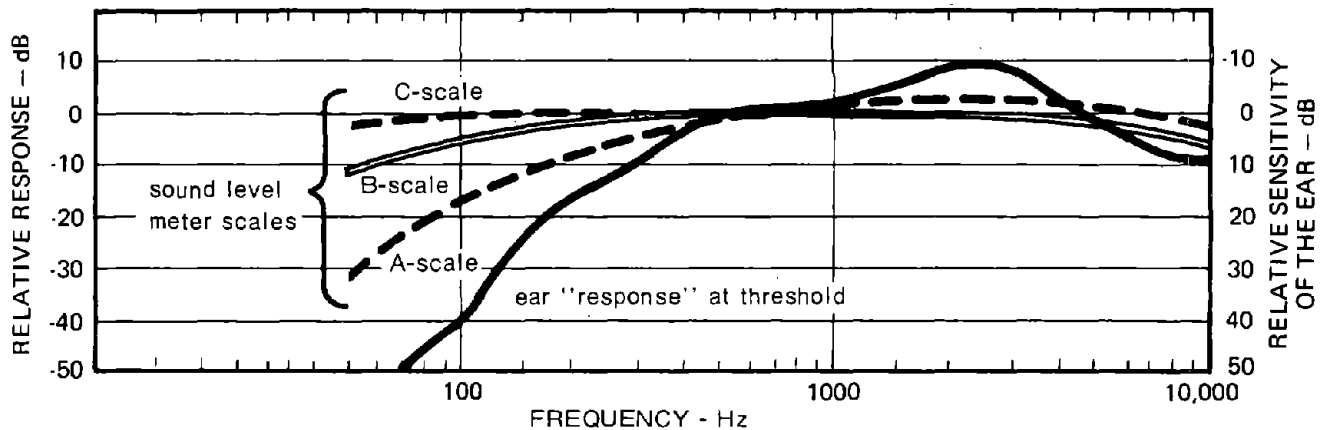

FIGURE 1.2 - Response characteristics of weighting scales and of ear at threshold

- $(L_C - L_A) > 0$ Low-frequency quality
- $(L_C - L_A) = 0$ Medium-frequency quality
- $(L_C - L_A) < 0$ High-frequency quality

For a fixed C-level, noise in the last two cases will induce more hearing loss than low-frequency quality noise. It must be noted that consideration of the actual level is left out of this spectrum quality parameter and must be considered first before quality judgments are made. As you get deeper into noise level measurements and analyses, you will find that this kind of single number description aids you when you need a quick, or on the spot, analysis of noise.

The evolution of the use of A-scale noise levels, L_A , has basically been the result of experimental evidence on the relative hearing loss from constant-level sounds of different frequencies. High-frequency sounds cause much more hearing loss than low. The similarity to hearing sensitivity was shown earlier in Figure 1.2. Thus, A-weighted sound has become the common legal description for

sound levels, because it incorporates a good single approximation to the weightings that show good correlation with such effects as loudness, speech interference and annoyance, as well as hearing loss. The American National Standard for sound level meters states that, unless otherwise indicated, sound level means L_A , in units of dBA. To convert flat response readings to A levels, apply the weighting factors at octave band center frequencies shown in Table 1.1.

TABLE 1.1 - Corrections from flat levels to A-levels

Octave Band Center Frequency (Hz)	dB (Change)
31.5	-39.5
63	-26
125	-16
250	-8.5
500	-3.0
1000	0
2000	+1.0
4000	+1.0
8000	-1.0
16000	-6.5

So far we have talked about noise as complex sounds or noise spectra and characterized the quality of noise, but we have not actually defined noise. The standard usage or accepted definition is that noise is unwanted sound. This is more a psychological than a physical definition. The sound of a racing car engine running may not be noise to you but to your neighbor it may be.

In a legal sense, noise is whatever sound may be subjected to regulation because of undesirable effects. Usually, sound level and duration are the predominant criteria. Effects of sounds or noise include not only hearing loss, but also annoyance, as well as speech and sleep interference.

Combining Noise Levels

A frequent calculation in noise control engineering is combining levels. Suppose we have two levels and we are interested in finding out what our sound level meter would read if the two sounds were simultaneous. We make the basic assumption that the noises are random; that is, only weak pure tones are present. The formula for calculating the combined level, L_c , given L_1 and L_2 , is

$$L_c = L_1 + 10 \log (10^{(L_2 - L_1)/10} + 1) \quad (1.4)$$

A practical example would be to have two closely spaced noise sources and to stand, say, about halfway between them. Measure the levels with a sound level meter, first with one on and the other off, then vice versa. Combination of the levels should give you the level if they were both running. This combination of sound levels of random noise requires adding the power or energy of each source and using the decibel or logarithmic transformation to get what is read on a sound level meter.

Some peculiarities in the measurement of sound and the use of decibels are worth mentioning. Doubling of the energy raises the level by 3 dB. For example, two equal random noises of 40 dB each combine to a 43 dB total. Two equal 90 dB random noises combine to 93 dB. The combination process uses the physical fact that the square of the sound pressure is usually closely proportional to the sound energy.

The chart of Figure 1.3 enables this combination to be performed without the formula.

For rough work, the scheme of Table 1.2 is easy to remember and to use; its results are usually good to ± 1 dB. To remember the break points at which 3, 2, or 1 dB is to be added to the larger level, note that the break point differences of 1, 4, and 9 turn out to be the squares of the first three integers. The exact values of these break points are 1.1, 3.8, and 9.1 dB.

As an example of the use of Table 1.2 and Figure 1.3, consider the problem of calculating the noise from several identical machines that are at different distances from the point at which the combined level is needed. Suppose that the noise from each machine

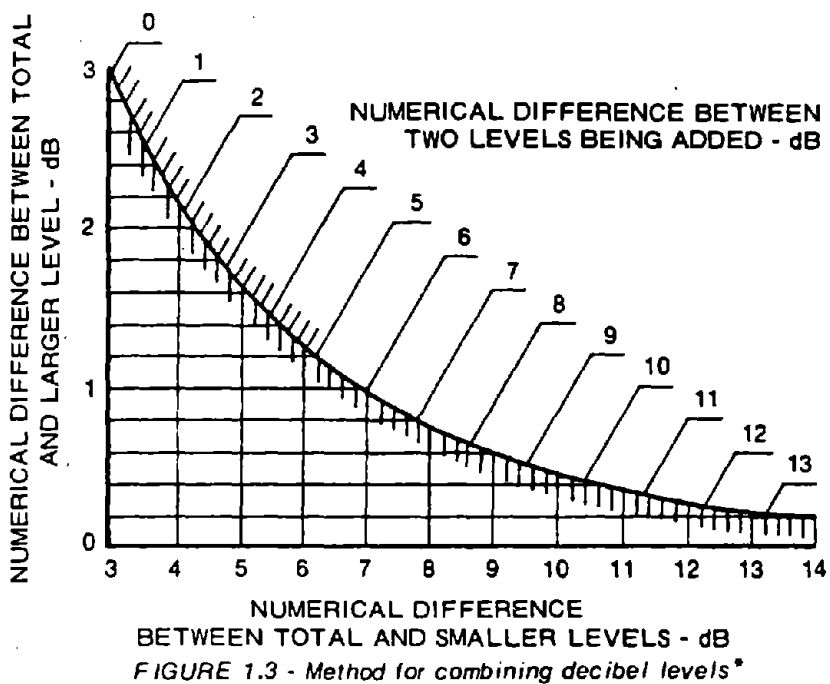

* From Handbook of Noise Measurement, General Radio Co., Concord, MA.

TABLE 1.2 - Method for approximating decibel combinations

Difference	Add to Larger Scale (dB)
0	3.0
1	2.6
2	2.1
3	1.8
4	1.4
5	1.2
6	1.0
7	0.8
8	0.6
9	0.5
10	0.4
11	0.3
12	0.2

operating alone is given by the levels in the first line of Table 1.3. In the second line we have arranged these, for convenience only, in order of increasing level. Successive lines below show the steps of combining levels in pairs by the rules of Table 1.2. The result is 98 dB. By rigorous calculation, the correct value is 97.5 dB.

TABLE 1.3 - Example of level combining

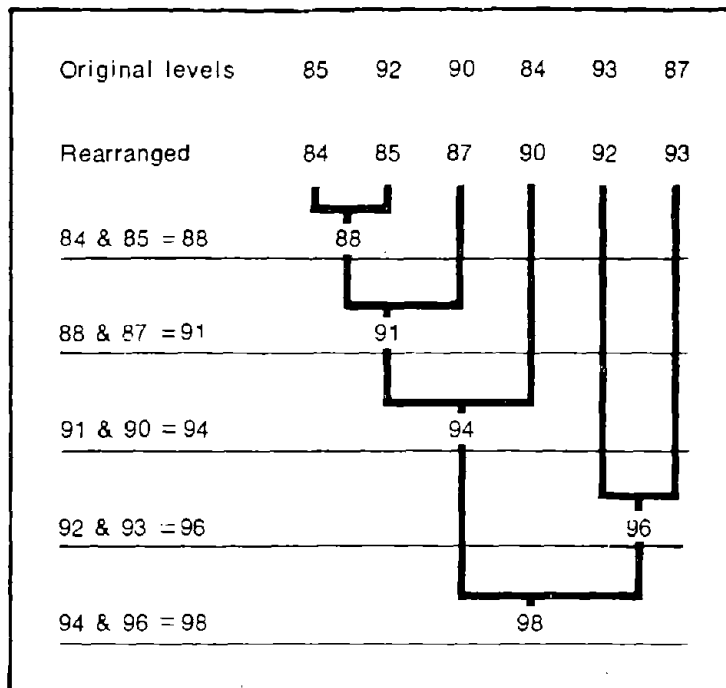

Noise Generation and Noise Fields

When investigating noise it is often convenient to consider separately the source, path, and receiver components of the problem. At the source we are concerned with the forces that cause surfaces to vibrate or air to generate turbulence, or both, and cause sound to be radiated. Along the path the sound spreads out and may be absorbed. The receiver is (for our problems) the human ear, with attention to the noise exposure experienced.

It is important to be acquainted with how the noise is generated and radiated. Such knowledge can sometimes permit the introduction of simple modifications to machines to reduce the amount of sound that is radiated. The two chief items about which information is usually sought are the exciting force and the size,

nature, and orientation of radiating surfaces. The usual excitation forces are from unbalanced rotational and reciprocating sources, impact aerodynamic sources, friction, magnetic sources (AC transformers), hydrodynamic sources (water hammer), and liquid cavitation.

Sound is radiated into the air by such surfaces as machine frames, panels, and guards; unrestrained stock and workpieces; such stressed parts as saws and dies; and friction-excited surfaces such as brakes. Fan blades leave a wake of alternating eddies behind. Steam and air venting makes noise by shear against the surrounding relatively still air; the sound power is typically proportional to the gas velocity to about the fifth power.

When sound spreads out from a small source with no major reflecting surfaces nearby, the sound level along the path decreases with distance. If the level at distance r_0 is L_0 , then at r the level is

$$L(r) = L_0 - 20 \log_{10}(r/r_0) \quad (1.5)$$

The term "inverse square law field" is given to the region in which equation (1.5) holds. Conversely, if we are reasonably certain that inverse square law conditions pertain, and we know the level at one position, then by (1.5) we can calculate the level at any other position in this region, along the same radius from the source at which the given level was measured. However, if the source is directional, then it will be necessary to measure at many angular values to get a complete description of the sound field.

As we have seen, the magnitude of the loudness sensation depends on the sound level at the ear. However, a complication develops when sound in a room, such as in a factory space, is to be calculated. At a sufficient distance from the source of noise, we will hear not only the direct sound, but also all the sound that is reflected from the room surfaces. The behavior of sound level with distance from a noisy machine is sketched in Figure 1.4.

There are three relatively distinct regions to which we shall refer. Close to the machine, or in the near field, levels will depend very much on near-by noise spots, such that levels may remain constant or may decrease. In the second region we have inverse square law behavior, where the noise from the machine is much greater than that reflected from the walls and other room surfaces. In the third region, the reflected sound predominates, and the level is relatively constant. Typically, because we are not dealing with ideal point noise sources, the falloff of noise level with distance does not behave in a smooth way. Differences in the way the noise falls off with distance away from the source will indicate to some degree the kind of noise control to be used.

The critical distance (r_c) concept is useful. Critical distance is that at which the noise level changes from inverse square behavior and becomes relatively constant (reverberant level) as shown in Figure 1.4. (For applications see Chapter 3.)

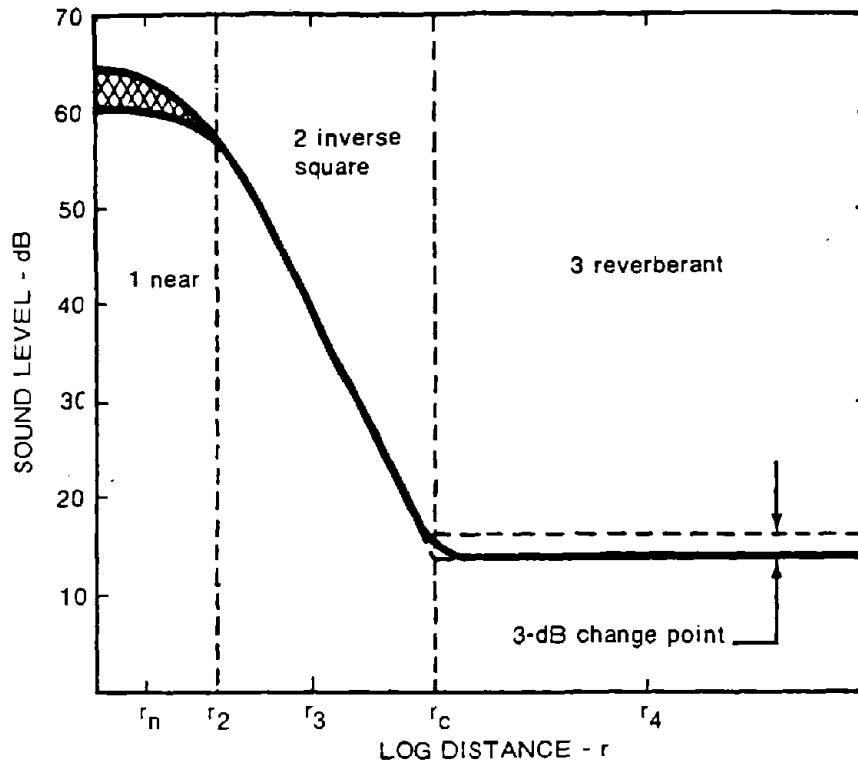

FIGURE 1.4 - Noise field around a single machine. Critical distance is r_c .

The junction between regions 2 and 3 (Figure 1.4) is at the critical distance, r_c . Beyond that distance, increased absorption on the room surfaces will reduce the reverberant level but not the level in the inverse square law level of region 2. The importance of this for noise control engineering is that if a worker is in region 2 (and most are), acoustical treatment of the room surfaces will not reduce the noise he receives from his own machine. The chief exception occurs when there are many machines, close together in a low-ceiling room. If a factory room has average absorption coefficient $\bar{\alpha}$ and has n identical floor mounted machines that emit noise equally in all directions, the critical distance is

$$r_c = 0.20 \sqrt{S \bar{\alpha} / n} \quad (1.6)$$

where S is the total area of the walls, floor, and ceiling and is measured in the same units as r_c . Note that additional absorption (increasing $\bar{\alpha}$) will reduce only those levels in zone 3, beyond the critical distance, r_c . Thus, the ambient room background levels can be reduced by increasing the acoustical absorption at room surfaces.

Sound Power

For calculating the reverberant sound field in region 3, it is necessary to know the total sound power emitted by the machines or a standard source in a room. Sound power cannot be measured directly but must be calculated from measurements made under closely controlled conditions, usually in the laboratory. One procedure uses a nonreflecting (anechoic) environment; another uses a highly reflecting room for the machine in question. It is usual to state, not the sound power, but the sound power level. This is defined by

$$L_W = 10 \log_{10} (W/W_0) \quad (1.7)$$

where W is the sound power in watt, and W_0 is the reference power of 10^{-12} watt, and corresponds to p_0 or 20 micronewton/m² reference sound pressure.

Except for absorption in the air, the radiated sound power is independent of distance from the machine. However, the intensity (power per unit area) does change inversely as the square of the distance away from a point source. The area over which intensity is measured is easily related to the shape of the measurement surface and the distance away from the source.

For calculating noise levels in the open, away from all reflecting surfaces, the sound pressure levels at various distances can be calculated by equation (1.5). However, in a room, and in factory workshops in particular, it is first necessary to start with sound power. Also, sound power characterizes the total noise from the machine and is useful in comparing different machines on a noise basis. In terms of hearing damage, however, it is the A-weighted sound pressure level that is needed and to which other measures must eventually be converted.

At our reference power $W_0 = 10^{-12}$ watt, the sound pressure level measured 0.28 meter away from this ideal point source would be zero with no reflecting surfaces.

The general relationship for a point source well away from any reflecting surfaces, emitting sound power level L_W is:

$$L_P = L_W - 10 \log S = L_W - 20 \log r - 11 \quad (1.8)$$

where r is in meters and S is in square meters; if r is in feet, replace the numeric 11 by 0.7. The constants are the result of the units used. Now for point sources this can be an extremely useful relationship. If the source is on a large flat surface such as a floor in middle of large room with no reflectors other than the surface, the relation is

$$L_p = L_w - 20 \log r - 8 \quad (1.9)$$

where r is in meters.

In the future, possibly the sound power (W) of a noise source will be the single more important parameter to know when analyzing the sound level in a room, especially with noise-rated machines. After some additional reading in references such as those listed in Chapter 7, you will be able to use equation (1.9) to aid in writing purchase specifications. Combination of the level you read on your sound level meter before a new machine is installed with the one you predict using equation (1.9), plus information on the acoustics of the room, will tell you whether the new noise level will be acceptable. If several machines are present, decibels may be combined by the rules discussed earlier to give the total level.

Summary of Symbols and Definitions

Some of the definitions used in sound measurements are summarized below.

W = Sound power

p = Sound pressure

ρ = Density of medium in which sound is being propagated

c = Speed of sound in medium

S = Area over which sound pressure is measured

r = Distance away from source

W_0 = Reference sound power, 10^{-12} watt

p_0 = Reference sound pressure, 20 micronewton/meter²

r_0 = Radius of reference sphere = 1 meter

ρc = 410 rayls, where ρ is the sea level density of air and c is corresponding sound speed at 20°C.

Chapter 2

MEASUREMENT OF NOISE

In the usual industrial noise situation, there will be two types of measurements:

- (1) Compliance measurements, which are made in accordance with some relatively precise set of instructions, usually based on laws or regulations.
- (2) Diagnostic measurements, which aid in engineering control of noise by locating specific noise sources and determining their magnitudes, and by indicating the types of controls needed, their locations, and the amount of reduction sought.

The two types will be explored in detail in this chapter.

Compliance Measurements

Compliance measurements are made with some relatively precise set of instructions, usually based on laws and regulations. The purpose is usually to determine the extent of compliance with the limits set forth in the laws or regulations. Thus, in a noise exposure compliance survey for industrial noise, the data will be the slow A-weighted levels measured at the ear location of the workers, together with the times spent at the levels encountered. From these data, the daily noise dose is calculated by means specified in the regulations.

Basic Instruments, Use and Calibration. The chief instrument for noise measurements is the sound level meter (SLM), which should be a Type 1 or 2, made in accordance with American National Standard S1.4 (1971), "Specification for Sound Level Meters." The Type 2 instrument has broader tolerances on performance than the Type 1 and is acceptable under the OSHA Occupational Noise Exposure regulations. It is usually less bulky, lighter, and less expensive than the Type 1 SLM. The SLM consists of an omnidirectional microphone, a calibrated attenuator, a stabilized amplifier, an indicating meter, and weighting networks. The networks provide the three common sound level meter filters: A, B and C, and can be set to either Fast or Slow response. More details on types of meters and their manufacturers are given in the discussion of diagnostic measurements later in this chapter.

When the noise levels are known to change very little throughout the working day, a simple SLM reading suffices. However, the reading must be taken properly. The standard procedure is to locate the microphone at the ear position concerned, but with the worker at least three feet away. This is the so-called free field measurement that is specified as preferred in American National Standard S1.13-1971, "Methods for the Measurement of Sound Pressure Levels." For a general standing position, the preferred microphone height is 1.5 m (about 5 ft); for a seated worker, 1.1 m (about 3.5 ft).

When it is necessary to make sound measurements that will withstand scrutiny in the courts, several criteria are important:

- (1) The data should be obtained by a qualified and disinterested individual, to avoid charges of bias. An acoustical consultant of known accomplishment, preferably also a registered professional engineer is appropriate.
- (2) The instruments and measurement procedures used should conform fully with the applicable American National Standards.
- (3) Instruments should be calibrated before and after each significant set of readings. If the calibration is out of tolerance, readings back to the previous calibration must be repeated.
- (4) The calibration should be traceable to the National Bureau of Standards.

Obtaining reliable data depends on periodic calibration of the instruments. The preferred calibrators deliver an acoustical signal of known frequency and sound pressure level. Some calibrators provide a variety of signals of different frequencies and levels. To ensure that the calibrators are correct*, it is best to buy two and reserve one (as a comparison instrument) which have been certified as to sound level by means traceable to the National Bureau of Standards.

The manufacturer's instructions for holding the SLM should be followed. The practice in the United States is to calibrate the microphone for a correct reading when the sound grazes the diaphragm

* For moderate use, annual calibration of the calibrator is often satisfactory.

of the microphone. Thus, the axis of the microphone is at a 90-degree angle to the direction the sound is travelling. Instruments made in Europe (such as the B&K) are calibrated to be correct when the microphone is aimed at the source. However, these instruments can be used with a random incidence corrector fitting, which effectively converts them to the U.S. type of use.

For both types the observer, microphone, and sound source must be at right angles to the direction of the sound. To be absolutely sure there is no interference from the body of the observer, position the microphone at least a meter away from the observer. With steady noise conditions, possible interference can be determined easily: with the microphone at a fixed position, decrease the distance between the observer and microphone to less than 1 m. The position at which a significant change in reading occurs indicates (for that specific situation only) how far away the observer need be.

For most industrial situations, a reading on the slow A-scale is specified for compliance measurements. Despite the averaging properties of the "Slow" setting, industrial noise is often variable enough that reading the meter becomes a problem.

As a general matter, it is best to first explore A-levels in the region of interest before obtaining the final sound level for compliance measurements. Sometimes directional effects can change the reading a few dB in a few feet. One example is a noise source that is partially shielded by a machine structure, with the operator in and out of the acoustical shadow. Several readings may be needed to completely delineate the noise in the range of positions used by the worker in question.

In sampling noise for obtaining statistical data using the "Fast" setting on the meter, you should allow no less than one-half second between observations; in using the "Slow" setting on the meter, an interval of at least two seconds is recommended. Machinery that operates at varying speeds or cycles of operation produces noise that fluctuates in level. Cyclical noises are those that change repetitively in excess of 5 dB. A suggested sampling method is to take readings, with the SLM set to slow response, every 15 seconds for a period of 3 to 5 minutes from which an average value can be calculated.

It is often necessary to record a single reading that is the average over a short period. The following rules may be used.

- (1) If the difference between average minima and average maxima is less than 6 dB, use the average of these two extremes.

- (2) If the difference is greater than 6 dB, use the reading 3 dB below the average maxima.
- (3) It is always preferable to record the range of readings if over 6 dB, plus comments on probable cause. Typical causes include machine cycling and very low frequency pulsation from air handling equipment.

When an operator performs various duties during the working day, he can be exposed to varied permissible noise exposures specified by the Occupational Safety and Health Administration (OSHA). These can be used to determine the total daily noise dose, as follows: When the daily noise exposure is composed of two or more noise exposures of different levels, their combined effect is the sum of the fractions, at all levels, of the actual time (hr) divided by permissible time. The sum of these fractions must be equal to or less than 1.0 for a permitted daily noise dose.

Permissible noise exposures are:

<u>Hours/Day</u>	<u>dBA</u>	<u>Hours/Day</u>	<u>dBA</u>
8	90	1½	102
6	92	1	105
4	95	½	110
3	97	¼ or less	115 maximum
2	100		

Exposure to steady noise of 115 dBA is the maximum allowed. Exposure to impulsive or impact noise should not exceed 140 dB peak. This cannot be measured on the basic sound level meter and requires more expensive special meters.

Some general precautions should be observed when using the sound level meter. Wind or air currents can distort readings (a wind screen attachment will minimize this problem and also protect the microphone in dirty industrial environments). Vibration of the meter, supported or on a tripod, can distort readings. Excess room humidity or temperature can also be a problem, as well as magnetic distortion of the meter from adjacent power equipment. Barriers or walls can obstruct sound and reduce measurements of a SLM, or, by reflection, increase measurements. Background noise should be at least 10 dB below the total measured level. (The instruction booklet with the meter gives corrections to readings for level differences below 10 dB.)

To avoid dropping the meter when it is hand held, keep the safety cord that comes with most meters wrapped around your wrist.

Many other nonacoustical data are required to support the noise dose information. Such data include plant location and product, pertinent personnel and their positions in the organization (especially important if they are to be witnesses), persons present during measurements, time span of measurements, room layout and dimensions, sketches of machines, descriptions of machines, production data, the daily time machines are producing, worker and measurement locations and photographs.

Dosimeters. If the employee (such as a maintenance or repair person) moves through differing noise situations, a dosimeter is a useful instrument for measuring noise. At the present time, there is no completed American National Standard covering the performance of dosimeters, although these instruments have been available for at least two years. Calibration is essential to dosimeters, and the manufacturer's instructions should be followed until standards for use are available. Any newly received dosimeter should be left on continuously for at least eight hours and calibrated periodically to determine if there are any shifts in reading.

Some observation of the employee wearing the dosimeter may be needed to attest to normal activity. By deliberately favoring high or low noise level positions, the employee can influence the indicated dose upward or downward. Readout should not be available to the employee directly from the instrument, lest the employee be encouraged to play with the instrument. The dosimeter should contain simple provisions (as circuit board replacement) for changes anticipated in OSHA regulations.

Diagnostic Measurements

Diagnostic measurements are made to aid engineering control of noise by locating specific noise sources and their magnitudes and by indicating the types of controls needed, their locations, and the amount of reduction sought. Such diagnostic measurements are not always straightforward, and their success depends mostly on the capabilities and experience of the person making the measurements. In a very real sense, diagnostic measurements of noise constitute a sort of detective activity, in which clues must be properly read, hunches followed up, and data cross-checked.

No single detailed method can be specified, for each situation is unique. However, workable general procedures and the equipment used are described below.

Sound Level Meters. Diagnostic measurements can be made with the Type 1 or Type 2 sound level meters that are limited to A, B, and C scales (B is not normally used) and "Fast" or "Slow" settings. The "Slow" setting is the basis for OSHA compliance regulations.

To the basic sound level meter, special attachments are available, including:

- Windscreen
- Earphone coupler
- Vibration pick-up and adaptor
- Tripod
- Extension cable for microphone.

This equipment package can be used to solve many noise source problems for which specific data based on an octave band analysis are not required. For example, absorption of a material is frequency dependent, but using the absorption data at 500 Hz will generally result in a satisfactory result because the reduced absorption at lower frequencies is offset by the lesser importance of these frequencies in an A-scale reading. Although these readings may result in using slightly better materials than the absolute minimum, in most cases this cost difference on a single installation is small. So the limitations of measurements with only A- and C-scale are of degree only. Many acceptable solutions have been developed without full octave band data. Many of the case histories included in Chapter 5 used only these basic data.

Table 2.1 lists the suppliers and model numbers of several sound level meters. The table also provides data on presence and/or availability of A, B, and C scales, "Fast" or "Slow" meter movements, calibrator, windscreen, and microphone extension cord; decibel range (for Type 2); and availability of an octave band analyzer, accelerometer, and amplifier.

Following Table 2.1 is a list of suppliers who state explicitly that their sound level meters meet at least Type 2 specifications under American National Standard S1.4-1971. These specifications are somewhat more rigorous than those of IEC 123, which are sometimes acceptable. If you are not sure that an instrument thus qualifies, any reputable manufacturer can supply the backup data.

TABLE 2.1 - Sound level meters and accessories available

Name, Model	Scales			Speed		Capabilities		Accessories					
	A	B	C	F	S	Peak	dB Range	Cal	WS	Ext	OBA	Acc	Ampl
ACOS SLM 3 (1)	X			X	X		50-130	X	X	X		X	X
Advanced Acoustical Research 101A	X	X	X	X	X		40-140	X	X		X		
Anstro SL-1 (1)	X	X	X	X	X		40-125			X		X	X
Bausch & Lomb	X	X	X	X	X		40-140	X					
Bendix 300	X	X	X	X	X		55-140	X					
B & K 2205	X	X	X	X	X		32-140	X	X				
B & K 2209 (2)	X	X	X	X	X	X	6-140	X	X	X	X	X	
Castle CS16A	X				X		60-130	X (3)					
Castle CS17A	X		X	X	X		20-140	X					
Columbia SPL-103	X	X	X	X	X		40-140	X					
Dahlberg GS-9510	X	X	X	X	X		20-130	X		X	X		
Dawe 1400G (1)	X	X	X	X	X		24-140	X (3)	X	X	X	X	
Digital Acoustics DA100 (2)	X	X	X	X	X	X	14-154				(4)		
Edmont 60-510	X				X		60-120	X					
Electro-Sonic 2010	X	X	X	X	X		40-140						
General Radio 1565B	X	X	X	X	X		40-140	X	X	X		X	
General Radio 1933 (2)	X	X	X	X	X	X		X	X	X	(4)	X	
Mamash S716	X	X	X	X	X		18-140	X			X		
Mechanalysis 308	X	X	X	X	X		45-140	X			X	X	
Metrosonics dB-201	X	X	X	X	X		40-140	X	X				
M-S-A	X	X	X	X	X		32-140	X	X				
Peekel GRB (1)	X	X	X	X	X		20-150				(4)	X	
Pulsar	X				X			X					
Quest	X				X		60-120	X					
RAC SPL-103	X	X	X	X	X		40-140	X					
Rhode & Schwartz ELT (2)	X	X	X	X			55-120	X	X			X	
Rhode & Schwartz EZGA (2)	X	X	X	X	X	X	20-160	X	X	X	X	X	
Scott 452	X	X	X	X	X		40-140	X		X			
Tracor SPL-103	X	X	X	X	X		40-140	X					
Triplett 375	X	X	X	X	X		40-140	X	X				
Unico SLP-21 (1)	X	X	X		?		25-130	X		X			

F = fast speed
 S = slow speed
 Cal = Calibrator
 WS = wind screen
 Ext = extension cord for microphone
 Peak = true peak reading capability
 OBA = octave band analyzer
 Acc = accelerometer
 Ampl = amplifier for extending low level range

Notes:

- (1) Conforms to standard IEC 123, slightly less rigorous than ANSI S1.4-1971, Type 2.
- (2) Conforms to standard ANSI S1.4-1971, Type 1, precision.
- (3) Calibrator is of falling ball type.
- (4) Octave band analyzer integral with instrument.

METER AND MANUFACTURER/SUPPLIER ADDRESSES

ACOS: Cowl Industries Ltd., Milwaukee, WI

Advanced Acoustical Research Corp., Sawmill River Road, Elmsford,
NY 10523

Amstro Corp., 120 Clinton Road, Dept. D, Fairfield, NJ 07006

Bausch & Lomb, Rochester, NY 14602 (as Columbia)

Bendix: National Environmental Instruments, Inc., P.O. Box 590,
Warwick, RI 02888

B&K Instruments, Inc., 5111 W 164 Street, Cleveland, OH 44142

Castle Associates: R-D Eck, Inc., 12 Dale Street, Waltham,
MA 02154

Columbia Research Laboratories, Inc., MacDade Blvd. & Bullens
Lane, Woodlyn, PA 19094

Dahlberg Electronics, Inc., P.O. Box 549, Minneapolis, MN 55440

Dawe Instruments Ltd., Concord Road, Western Avenue, London W3,
England

Digital Acoustics, Inc., 1415 E McFadden, Santa Ana, CA 92705

Edmont-Wilson, Coshocton, OH 43812

Electro-Sonic: Monotherm Insulation Systems, Inc., 551 So.
Yosemite Ave., Oakland, CA 95361

General Radio Co., 300 Baker Avenue, Concord, MA 01742

Mamash Applied Science Laboratories Ltd., Ramat Aviv, Tel Aviv,
Israel

Mechanalysis: IRD-Mechanalysis, Inc., 6150 Huntley Road,
Columbus, OH 43229

Metrosonics, Inc., Box 18090, Rochester, NY 14618

Mine Safety Appliances Co., 201 N Braddock Ave., Pittsburgh,
PA 15208 (as B&K 2205)

Peekel Laboratorium voor Electronica N.V., Alblasstraat 1,
Rotterdam, The Netherlands

Pulsar Instrument Co., 650 So. Vaqueros Street, Sunnyvale,
CA 94086

Quest Electronics, 510 Worthington Street, Oconomowoc,
WI 53066

RAC: Research Appliance Co., Rt. 8, Allison Park, PA 15101
(as Columbia)

Rhode & Schwartz, Muehldorfstr. 15, 8000 Muenchen 80, West
Germany

Scott Instrument Laboratories, 533 Main Street, Acton,
MA 01720

Simpson Electric Co., 5200 W. Kinzie Street, Chicago, IL 60644
(as General Radio)

Tracor Medical Instrument Division, 6500 Tracor Lane, Austin,
TX 78721 (as Columbia)

Triplett Corp., Bluffton, OH 45817

Unico: National Environmental Instruments, Inc., Fall River,
MA 02720

Octave Band Filters. This equipment is normally an attachment to a sound level meter. It measures the sound pressure level in each octave band, normally from 63 Hz to 8000 Hz. Separate octave band analyzers often include weighted band readings of A and C (slow and fast) plus peak readings. This instrument can spot the band in which a maximum occurs. This aids in determining the noise source, as for example in verifying that the blade-pass frequency of a fan is in the band with maximum level. With the data from the octave band analysis, barriers and enclosures may be designed in detail, using the prediction of the required attenuation as a function of band frequency. By investigating the source in the machine having the same frequency as in the band maxima found at the operator position, you can determine the exact reason for the noise level and possibly change it by redesign, local barrier or enclosure, damping, or other methods, which will be discussed in Chapter 3.

Fractional Octave-Band (Proportional-Band) Analyzers. Depending upon the degree of exactness required, proportional-band analyzers can be obtained for 1/3 octave or 1/10 octave. This fine resolution would find critical use where machine redesign is contemplated and all specific noise sources need to be identified to lead to corrective design to reduce noise. This is normally not the problem on existing equipment, for which noise can usually be controlled by barriers, enclosures, isolators, damping, and so on. Exceptions occur when sources of single frequency noise may be close together in frequency, and fine resolution may be required. The usual example is that of isolating the contributions from gearing systems, where several gear tooth passage frequencies (and harmonies) may be close together.

Photographic Equipment. The role of photography in documenting the situation cannot be over-estimated. You will need a single lens reflex camera, a 28 or 35 mm close-focusing wide angle lens, and an electronic flash, preferably with automatic control and remote sensor. The flash should be wide angle. Be careful with the flash gun if explosive atmospheres may be present; you may not be allowed to use it. If at all possible, include a scale of length in all photos. Use Tri-X or similar high speed film. If you cannot use flash, a tripod may be needed for time exposure photographs. An essential part of the photographic effort is documenting the acoustical and production conditions for each shot. If you have a plan or sketch of the workroom, establish a dimension grid and refer to that in your notes on each shot. The first exposure in each roll should be a close-up of a sheet of paper on which you indicate the necessary identification information. Start with establishing shots that show the entire area and the relations of the machines to each other. Take pictures from several angles. Then come in closer to show the whole machine, again at several angles. For every microphone position at which sound

level data are obtained, photograph the setup. Use close-ups for added clarity. When noise sources are identified or even suspected, photograph their locations from several angles, showing the relations to other parts of the machine.

The photographs will be useful for documenting the measurements, for revealing machine features that must be considered when noise control means are designed, for showing worker positions, for identifying competing noise sources, and for possible evidence in any legal procedures.

Tape Recorders. A suitable battery-operated magnetic tape recorder can be used to obtain a noise sample for repeated analysis in the laboratory. A major difficulty is that tape recorders are adjusted for optimum operation with speech or music signals. Industrial noise signals may be different enough in peak-to-average level characteristics and in spectrum shape that the full performance of the tape recorder cannot be realized. Competent advice should be sought before purchasing a tape recorder for noise. Some instrument manufacturers are now supplying such tape recorders.

A convenient combination is a precision (Type 1) SLM and a two-channel (stereo) tape recorder. The SLM serves as the input device to the tape recorder. By proper setting of the controls, and with a knowledge of the peak levels present, it is possible to make tape recordings from which most of the original information may be recovered. There is one exception: for complex noise signals, the original and playback signal waveforms will usually not be the same. Hence, do not expect a tape recorder (unless specially adjusted or equalized) to provide the same peak-to-average level information that was in the original noise signal.

To recover actual levels from the tape record, you must record an acoustic calibration signal of known sound level. This signal is conveniently supplied by the acoustic calibrator used on the microphone of the SLM. Use it to calibrate the SLM, and connect the latter to the signal channel of the tape recorder. The tape recorder should have a meter that indicates recording level. By a series of qualifying measurements on the tape recorder, you should have established for each octave band the level above the top end of the meter scale at which distortion becomes excessive, and the level below the bottom end of the meter scale at which internal noise limits the signal that can be recorded. The distortion limit is often considered to be the level at which the playback is 1 dB below that expected on a linear basis.

While the calibration signal is being recorded, use the other stereo channel for voice recording of notebook information: data, time, job number, location, description of setup, description of calibration signal, and most importantly, settings of all controls

on SLM and tape recorder, together with the time, and a brief description of the content of the run.

On playback, the scheme for recovering the absolute levels, depends on that fact that the output voltage from the SLM depends only on the reading of its meter and not on the settings of its attenuator(s). For example, suppose that the calibration signal sound pressure level is 114 dB and that the meter scale is 0 to 10 dB. Then the SLM range switch will be set at 110 dB, and the meter movement will read 4 dB. The output voltage from the SLM due to the calibration signal is then recorded. Next, suppose you tape a noise that fluctuates between 85 and 95 dBC (not dBA). Then you set the SLM range at 90 and note this setting on the voice channel. On playback into a suitable system (which may be the same SLM) with a decibel output scale, you set the controls so that the calibrate signal reads 4 dB on the output meter.

Then when the unknown noise signal is played back, zero dB on the output meter corresponds to the range setting on the SLM when the signal was recorded "flat", that is, with the dBC or preferably "linear" setting. Then suppose on playback you wish to insert an A-weighting filter; if the SLM is being used as the playback indicator, set it to A-scale. If the output meter reads 2, then the level was 92 dBA (original recording with the SLM range at 90).

If the original signal has large low-frequency content, such as noise from process air blowers, it may all too easily overload the tape recorder. For such signals, recording can be done with the A (or B) scales to remove some of the excessive low-frequency noise. Thus, on playback using a "flat" system, the total level will be in dBA (or dBB). Octave band levels can be then approximated by adding the weighting for band center. However, if the spectrum slopes rapidly, additional and more uncertain corrections are needed.

Another use for a tape recorder is as an electronic notebook. In this use, all data, descriptions, comments, and suggestions for noise control can be placed directly on tape. Use a cassette recorder, preferably one taking standard cassettes. It should also have an automatic volume control and an automatic voice switch to initiate recording simply by talking. Set recording level low so that you must speak loudly when the microphone is directly in front of your mouth. This procedure will increase the signal to noise ratio so that you can make understandable tapes even when the noise is in excess of 105 dBA.

Other Equipment. For diagnostic measurements you will need, as described above, a standard Type 1 SLM, preferably with peak-reading capability; octave band analyzer; calibrator; heavy-duty

tripod strong enough to hold the meter; extension cord; lightweight tripod to hold microphone on extension cord end and also to serve as a wand for probe measurements; accelerometer and integrator network; tape recorder; voice microphone for tape recorder; and a camera, flash, and tripod.

Other equipment that you will find useful in diagnostic measurements includes a time and motion study stop watch calibrated in hundredths of a minute (not seconds) for measuring exposure time; a steel tape calibrated in both inches and centimeters; an optical range finder (to 150 feet) for getting dimensions (especially ceiling heights) when building or workroom plans are unobtainable; an inclinometer for getting heights of stacks beyond the range of the rangefinder; a hand tally counter for counting repeated operations, such as a punch press; and a vibrating reed tachometer for obtaining rotational rates of fans, etc.

Making readings. At the worker's ear, obtain the peak sound level, the A and C levels, and the octave band sound pressure levels from (at the most) 31.5 Hz to 16,000 Hz (usually 63 through 8000 Hz suffices). Be sure the same machines are operating throughout the measurement period. The A-level weights each octave band level to make the total consistent with the judgement of the human ear. Conversion of flat response to A-level was discussed in detail in Chapter 1 (Table 1.1).

Relating to A-levels. A useful technique is to identify the A-weighted band that contributes most to the A-level and set the octave band analyzer for the frequency of this maximum band. Then with the probe microphone, locate the area on the machine responsible for the maximum contribution in this band.

If a peak reading SLM is available, it can be used to advantage when you suspect that impacts or high frequency noise bursts are important components of the noise. Maximum peak level permitted by current regulations is 140 dB. For many industrial noises, the peak sound level minus the A-level is in the range of 14 to 16 dB. For sounds like chains rattling against metal panels, this difference may exceed 30 dB. Candidate sources of impact noise include metal-to-metal contact, rapid linear acceleration of parts, short duration air noise bursts, and metal parts traveling down metal chutes. The peak-to-dBA difference should increase as the impact noise source is approached.

A useful field technique in diagnostic measurements is to observe the difference between the A-level and the maximum A-weighted octave band. The greater the difference, the more likely it is that several A-weighted octave bands of approximately the same level are contributing to the total A-level. If the difference is small, it is likely that pure tones are causing the level in one A-weighted octave band to be much greater than others.

When the C-level is greater than the A-level, there are strong low frequency components, but when A is greater than C, the energy is mainly in the high frequency bands.

For making close to the source readings, many sound level meters come with an extension microphone cable that can be used to probe into those portions of the machine at which candidate noise sources are located. Sources include surfaces excited, for example, by rotary unbalance, vibrating panels, metal-to-metal impact, vibration of unrestrained workpieces, rapid acceleration of machine parts, friction, worn gears, poor bearings, hydraulic systems, air and steam discharge, and materials handling noise (chutes, conveyors). The action needed to reduce the A-level of noise can be selected in part by a knowledge of the frequency region that contributes most to the A-level. You will rarely find that the bands centered at 250 Hz and below contribute significantly to the A-levels of noise (see Table 1.1 in Chapter 1). For most industrial noises, the maximum A-weighted contribution is in the 500 to 2000 Hz region.

Vibration. Vibration measurements can often be used to verify the connection between received sound and its source. Candidate locations are thin machine structural panels and belt guards. However, there is no reliable connection between amount of vibration and A-level. Nevertheless, in more difficult diagnostic problems, vibration measurements can prove useful. If the spectrum of the average alternating acceleration of a surface is similar to that of the noise around it, it is likely that most of the noise below about 400 Hz came from that surface. Above 400 Hz, average surface velocity is a good indicator. Some sound level meters have vibration attachments based on accelerator input. With some meters, a resistor/capacitor integrating network is available so that acceleration, velocity, or displacement may be read from the SLM. There is as yet no standard means of calculating noise levels from vibration measurements, especially at higher frequencies. Use the mean square reading over a surface, rather than a single reading.

Occasionally vibration requires analysis with more sophisticated instruments, such as fixed narrow band analyzers, or 1/2, 1/3, or 1/10 octave analyzers. Such instruments are usually used in the laboratory, but field use is possible.

Ears and Mind. Trained ears play an important role in diagnostic measurements. They serve as spectrum analyzers and directional indicators. Masking of the observers own speech can also provide rough indications of sound level, once a personal calibration has been developed. The observer must be listening critically during all measurements to detect when an unusual noise event may have occurred. This event is often a change in operation of a machine and may require a new set of data on that condition.

The high-frequency directionality of the ears can be greatly enhanced by cupping the hands behind the ears. On turning the head, it will be easy to localize the noise sources in the plane of rotation. By doing this at a couple of positions around the machine, you can often home in on a suspected source location. Because most of the A-level is ordinarily due to higher frequency noise, this localization by ear is very helpful.

Another clue to source location is the shielding of noise by a part of the machine. If the ear or a probe microphone is swept past the suspected region, there will be a sudden drop in level (particularly in high frequency octave bands) as the source is eclipsed.

General Tips. Diagnostic measurements are directed toward noise from specific machines, not the noise from many sources that is received by a worker in a compliance measurement situation. Ideally, only the machine in question should be operating to avoid contamination of the measurements by noise from other sources. The machine may then be put through its several operating modes: idling, full production, or with some functions selectively disabled. These modes of operation aid in identification of noise sources that may be close together or have noise levels nearly identical.

This ideal arrangement is usually impossible, and measurements must ordinarily be made during normal production. However, if the noise is relatively continuous and does not contain audible pure tones, it is possible to calculate for each octave band the level due to the machine alone. The only requirement is that at some time during the measurements, the machine in question must be off. This often occurs, owing to jams, maintenance, rest breaks, or change of work. Measure the noise from all other sources, as well as the noise with all machines operating. If there are small changes between the two noise level measurements, it is possible to infer the noise level (in each octave band) from the machine as if it alone were operating. The principle is simple: the total noise is the sum of the two contributions: machine and everything else. However, since decibel levels do not add directly, calculation is needed. The scheme works best when the difference of the two levels is over 2 dB.

Combining Decibels. Decibel levels cannot be added directly. If there are two equal noise sources, the combined noise level is 3 dB greater. If the two noise sources are unequal, a smaller number of decibels on a graduated scale of difference is added, as discussed in Chapter 1 (see Table 1.2 and Figure 1.3).

This same method can be used in combining octave band values two at a time to get overall spectrum (flat) values, or if octave

bands are A-weighted, to obtain overall A-values (approximately what the ear hears).

Thus, when data are available for levels from several machines, as explained above, and the decibel decrease is recorded when the machine under study is shut down, you can determine the decibel decrease to be subtracted from the reading with all machines on to give the contribution from the machine under study. In the following list, \bar{a} is decibel decrease when the machine under study is shut down, and \bar{b} is the number of decibels to be subtracted from the reading with all machines on to give the contribution from the machine under study.

\bar{a}	\bar{b}	\bar{a}	\bar{b}	\bar{a}	\bar{b}
0.5	9.6	4.5	1.9	8.5	0.7
1.0	6.9	5.0	1.7	9.0	0.6
1.5	5.3	5.5	1.5	9.5	0.5
2.0	4.3	6.0	1.3	10.0	0.5
2.5	3.6	6.5	1.1	11.0	0.4
3.0	3.0	7.0	1.0	11.5	0.4
3.5	2.6	7.5	0.9	11.5	0.3
4.0	2.2	8.0	0.7	12.0	0.3

Final levels should be rounded off to the nearest decibel.

Decibels can also be combined mathematically by using the formula in constructing the above table:

$$L_2 = L_1 + 10 \log (10^B - 1) \quad (2.1)$$

where $B = (L_c - L_1)/10$

L_c = Combined level, background plus machine level

L_1 = Background level (all other machines)

L_2 = Machine level

Data Requirements. Depending on the noise source and the possible methods of noise reduction contemplated, some or all of the following data may be required:

- (1) Sound pressure levels, A and C, at location of interest (operator position) for compliance measurements plus peak.
- (2) Octave band analysis made 1 ft from the source, or at any distance for which noise from that source predominates.

- (3) Octave band analysis made 1 meter from a surface that envelopes the source. Use in sound power calculations.
- (4) A and C at critical distance: the point where there is a 3 dB increase when approaching the noise source, above the generally constant level remote from the source (only that source operating).
- (5) Background noise level: A and C, and octave band.
- (6) Noise source probe readings in near field, comparing fast and slow readings related to machine operation if possible. Use for diagnostic measurements.
- (7) Sketch of area, machine, noise source, and operator location. Augment with photographs if required for later analysis.
- (8) Vibration measurements to determine acceleration levels of vibrating surfaces (in some cases velocity and displacement) plus description of vibrating region. For isolation requirements, obtain weight on footings and lowest forcing frequency (rpm of motor, drive, and other vibration contributors).
- (9) General data, such as type and description of machine, type of stock and product, production rate, requirements for monitoring and access, use of automation, locations with respect to other machines, dimensions of enveloping surface, times of measurements. Also information on all personnel concerned.
- (10) Plot data on octave band form (Codex graph paper No. 31460 or equivalent).

The basic aim of this documentation is to record as clear an understanding of the noise sources as possible for detailed analysis later. The documentation should be such as to be clearly understood by others and to serve as reminders of the problem details for final corrective recommendations.

Several things about the noise can be learned from the basic sound level readings, A and C, and the octave band data (Items (1) through (3) above):

- C greater than A indicates low frequency components predominate
- A greater than C indicates high frequency components predominate

Peak minus A indicates impact when greater than 14-16 dB

A minus maximum A-weighted band of 6 dB indicates possibility of 4 high A-weighted octave bands

A minus maximum A-weighted band of 5 dB indicates possibility of 3 high octave bands

A minus maximum A-weighted band of 3 dB indicates possibility of 2 high octave bands

A minus maximum A-weighted band of close to zero indicates strong pure tones

The data about an enveloping surface can be used later if they are found to be an advantage in estimating sound power. Sound power is estimated by placing an imaginary surface one meter away from a surface that envelopes the machine and touches it at all essential areas. Measure the noise in each octave band one meter away from this imaginary surface where the noise (A-weighted, for example) changes by about 5 dBA or more. The enveloping surface is quickly defined by drawing a box around the machine with a chalk mark on the floor. By moving the microphone over a surface one meter away from the enveloping surface, you can locate each measurement spot. If this is done carefully, the value of the sound power can be obtained. The sound power level associated with a given surface is

$$L_W = L_p + 10 \log S \quad (2.2)$$

where L_p is the sound pressure level,

S is the area in m^2 at each position, and

L_W is the sound power level in dB re 10^{-12} watt.

Since equation (2.2) must be used for the level of each octave band for the total surface area, you must use the combination rules developed in Chapter 1 to obtain the total power for each octave band and then the total A- or C-weighted power. Sound power information will be used to determine expected sound pressure levels if room acoustics are changed, which will be discussed in Chapter 3.

Follow-Up Measurements. After the changes have been made to reduce the noise level (to be discussed in Chapter 3), a follow-up series of measurements should be made to record the attenuation achieved. These measurements are usually made at the operator position, and revised noise dose is calculated to determine if the results are now in compliance with current regulations. This gives a permanent file record covering the original noise level and noise dose calculations, method of noise reduction or insertion loss* of noise attenuator, and final noise level and noise dose calculations. Such data are useful, should a similar problem arise in the future.

* Insertion loss is defined as the reduction in level at a measurement point after noise control means have been introduced.

Chapter 3

NOISE CONTROL TECHNIQUES

The objectionable noise sources have been identified and measured as outlined in Chapter 2, Measurement of Noise. In noise control analysis the next approach is to consider where the most effective and economical control of the noise can be obtained: at the source, the path, or the receiver, and in what order, if more than one treatment is needed.

Source

A full knowledge of the operation or process is needed to answer the basic questions: Can the machine or operation be eliminated or replaced by a quieter operation with equal or better efficiency (weld for rivet, etc.)? Can the present noisy machine be replaced economically by newer equipment designed with lower noise levels (perhaps as well for increased production)? Can the specific noise source be corrected by minor design changes (avoiding metal-to-metal contact by use of plastic bumpers, replacing noisy drives by quieter types, use of improved gears, improved maintenance, etc.)?

Can the specific machine elements causing noise be corrected by a local source approach rather than considering the entire machine as a noise source? (Later data covering the specific designs for barriers, enclosures, damping vibrations, vibration isolation, lagging of vibrating surfaces, mufflers and silencers for air and gas flows, reduced air velocities of free jets, etc., may be considered for the individual noise producing elements of the total operation.) Can the noisy machine elements be moved (such as pumps, fans, air compressors that service the basic machine but need not be an integral part)? Can the machine parts be vibration isolated to reduce airborne noise from vibrating panels or guards?

The major constraints in changes of noise sources will be stated including interference with the productivity of the machine or the operator, and the relative costs of alternative choices developed. Some of the specific noise reduction methods that can be applied at the noise source are:

1. Distance or relocation
2. Vibration control or isolation
3. Damping of vibrating surfaces
4. Lagging of vibrating surfaces

5. Air (and gas) flow and jet noise reduction by design, mufflers
6. Hydraulic systems, acoustic filters, surge tanks
7. Motor air cooling mufflers
8. Mechanical drive enclosures
9. Balancing of rotating equipment
10. Noise source enclosures

Distance or Relocation. Can a noise source be moved further away from the operator? Distance reduces noise level from a point source by 6 dB per each doubling of distance in a free field. In a closed space such as a factory work room, reverberant sound will eventually determine when no further reduction by distance may be obtained. The distance at which this occurs is called the critical distance (see Chapter 1). Relocation may apply to machine service units such as pumps, fans, drives, hydraulic systems, and air and steam flows that may be relatively easily moved and do not need constant attention.

Vibration Control or Isolation. Vibration control or isolation can be investigated on two bases: isolate a vibration source, such as a motor-pump assembly that is part of a machine, or vibration isolate the entire machine. A separate noise level test with the component on and off would help to determine if the component is a major contributor to the total noise.

Vibration control is necessary for quiet operation, and equipment mountings should be reviewed and changed from solid mountings to vibration isolating mountings of springs, rubber, cork, felt, or fiberglass as the situation requires. Vibration causes flat panel surfaces of machines, guards, and building structures to radiate noise. The excitation can come from rotating equipment, vibrators, tumblers, or shakers, and the introduction of isolation between the machine and such surfaces is often the complete solution to some noise problems.

Vibration isolators are commercially available. They are selected by specifying the weight supported, the deflection required, and the lowest vibratory frequency of the unit to be isolated. They are made from elastomers (rubber in compression and shear, ribbed rubber); other compressible materials (cork); fibrous mats (felt, fiberglass); and steel springs.

Basic isolation requires a knowledge of the lowest forcing frequency (f) of the machine to be isolated, as related to the

natural frequency of the isolator (f_n) plus machine, and the weight on the footing to be isolated. The transmissibility of vibratory energy is greatest (and is to be avoided) when the ratio of $f/f_n = 1$. Isolation begins above $f/f_n = \sqrt{2}$. The isolator plus machine resonance frequency f_n is determined from

$$f_n = 3.13 \sqrt{1/d}, \text{ where } d \text{ is the static deflection of isolator}$$

under load in inches. This relation holds only when the deflection is strictly proportional to the load (linear systems).

The steps for selecting spring isolators are (Bell 1973), B.4:

- (1) Establish that part of the total weight that is on the footing in question.
- (2) Determine lowest forcing deflection required for degree of transmission percent required (see Table 3.1); 5% is normally adequate.
- (4) Choose a suitable isolator that will sustain the load and have the proper deflection. Isolator manufacturers often list spring constants (lb/in. deflection).
- (5) Ensure that deflection is uniform for each footing.
- (6) For more complex isolation problems, submit the data from vibration tests to isolator manufacturers for more exact specifications.

TABLE 3.1 - Required static deflection (inches) for common industrial speeds or forcing frequencies (base is assumed immovable)

Speed rpm	freq.	Vibration Transmission (percent)				
		0.5%	1.0%	5.0%	10%	25%
3600	60	0.55	0.27	0.06	0.03	0.01
2400	40	1.2	0.62	0.13	0.07	0.03
1800	30	2.2	1.1	0.27	0.12	0.05
1600	27	2.8	1.4	0.29	0.15	0.07
1400	23	3.6	1.8	0.38	0.20	0.09
1200	20	4.9	2.5	0.52	0.27	0.12
1000	17	7.1	3.6	0.74	0.39	0.18
800	13		5.6	1.2	0.61	0.28
600	10			2.1	1.1	0.49
400	7			4.6	2.4	1.1

The selection of isolator pads follows the same general method, using the data from the suppliers as to the recommended grade, material, and thickness. However, many pads are highly nonlinear and cannot be selected directly on the above basis.

A pump-motor set mounted on a common platform furnishes a typical isolation problem, and also one that has a simple solution: use four properly selected vibration isolators.

Other vibration problems can be more complex, and the suppliers of isolating devices should be consulted. Give them the machine weight, operating frequencies, weight distribution on footings, and test measurements covering acceleration, velocity, and displacement at machine footings and at other points on machine to aid in determining the isolator requirements. For example, machines with low forcing frequencies may require a heavy concrete inertia block, generally 1.5 to 2.0 times the weight of supported equipment. In addition the inertia block and entire support structure could rest on spring isolators.

Another problem is a machine on a rather limber floor. Such designs and specifications call for special expertise. Complex vibration in more than one plane also requires specialized assistance from the suppliers or a qualified consultant. Under optimum conditions, the reduction in noise level (in dBA) should range from 2 dB for a machine with no vibrating panels, mounted on a very heavy inertia block, to perhaps as much as 14 dB for a heavy machine on a second story and limber floor.

Damping. Damping is the reduction of vibration and resultant noise by adding a layer or layers of vibration-absorbing material to either side of the vibrating surface. For example, metal parts striking a sheet metal pan cause noise that can be damped with a wide variety of materials including roofing paper, sheet lead, damping compounds, special tapes, acoustic lagging, and other commercially available materials to fit the problem.

Surface acceleration readings made in the diagnostic measurements can point out problem surface areas that are efficient noise radiators. Power radiated as low-frequency sound from a vibrating surface can be estimated from acceleration readings:

$$W \text{ (watt)} = 5.3 \times 10^{-2} g^2 S^2 \quad (3.1)$$

g = Average (root mean square over surface)
acceleration in g - units

S = Area of surface, m^2

The free field sound pressure level from a point source can be determined from sound power level from the formula:

$$L_p = L_w - 20 \log r - 0.7 \quad (3.2)$$

(r = distance from source in ft).

This relation does not hold close to a machine with many noise sources, or at a sufficient distance in a workroom where reverberant sound predominates.

The dominant frequency, f_D , can be estimated from acceleration and velocity:

$$f_D = a/2\pi v \quad (3.3)$$

a = acceleration (m/sec²)
v = velocity (m/sec)
f = frequency (Hz)

Lagging. Lagging of pipes or other surfaces radiating noise is a combination of a resilient member, noise absorption, and shielding. It usually consists of 1 to 4 inches of resilient acoustic sound absorber covered with a layer or layers of heavy shielding such as sheet lead, lead filled vinyl, or other metal protective coverings.

Some typical constructions and attenuations are given below (in dB):

	<u>500 Hz</u>	<u>1000 Hz</u>	<u>2000 Hz</u>
1-in. Molded fiberglass and aluminum foil covering	1.5	4.8	13.8
1-in. Molded fiberglass and lead impregnated vinyl	5.0	12.0	24.0
2-in. Molded fiberglass and lead impregnated vinyl	4.5	13.5	26.0

- Notes:
1. Fiberglass is 4 lb/cu ft. Lead vinyl is 0.87 lb/sq ft.
 2. Note low attenuation at 500 Hz, less at lower frequencies.
 3. Good seal at all joints is critical.
 4. In special cases two layers of 2-in. fiberglass plus lead impregnated vinyl between layers plus a cover layer of lead impregnated vinyl would increase attenuation.
 5. Sheet lead of same weight/area would also satisfy.
 6. Source: Dear, 1972, P.15.

Air and Gas Flow Noise Reduction. To reduce the noise of air and gas flow and discharge, silencers are used: absorptive silencers contain porous materials to absorb and reduce noise; reactive silencers depend on reflection (impedance mismatch) of the sound waves as the basic noise reduction method. A combination of both types is used in some designs, with various configurations.

Commercially available silencers are specified by the insertion loss (by octave bands) and by other specifications such as velocity of flow, temperature, and allowable pressure drop. Large industrial silencers are also known as snubbers and are sometimes combined with spark arrestors. There is a great deal of art in silencer design. One unsolved problem with dissipative silencers is fouling of the absorbent by particulate matter. In general, under such conditions, do not use a dissipative silencer.

Fans and blowers when near or part of an operation can be a major noise source. Fan types used are propeller, axial, and centrifugal. Blades on centrifugal fans may be radial, forward curved, or backward curved, but backward curved blades are the quietest. The resulting air noise is a combination of blade-pass frequency and harmonic peaks plus broadband aerodynamic noise and turbulence.

Reduced speeds will reduce noise, and replacement with lower noise level fans such as backward curved blade types can be considered. If this is not practical or economical, the air flow noise can be reduced by commercial or custom-made silencers. Custom-made silencers that can be constructed in maintenance shops include acoustical labyrinths, parallel baffle silencers, acoustic lined plenums, acoustic lined ducts, and acoustic lined bends.

If duct walls are lined with an absorbent with absorption coefficient, α , the dB reduction obtained is given by

$$\Delta L = 12.6 P \alpha^{1.4} / S \quad (3.4)$$

ΔL = Change in sound pressure level

P = Perimeter of duct, inches

S = Area of duct, square inches

α = Coefficient of absorption (note that this is frequency dependent, so octave band data will be used to determine required insertion loss and length of duct to be treated.

Plenum chambers can also be lined with sound absorbing material. An approximate relation for the reduction in level is:

$$\Delta L = 10 \log (\alpha S_p / S_b) \quad (3.5)$$

α = Coefficient of absorption of liner
 S_p = Area treated on plenum walls
 S_b = Discharge area of blower

An absorbent lined bend should add about 5 dB attenuation, with length of treatment at about five times duct width. Commercial silencers are available for greater attenuation to fit any fan or duct size, and suppliers can give insertion loss at each octave band under varied conditions of flow. Note that noise travels both upstream and downstream, and silencers may thus be needed on both intake and delivery sides of the fan.

Air Jet Flow. In industrial applications where high velocity air is discharged, shear-induced boundary layer turbulence can be a serious noise source. Normally, maximum levels from this aerodynamic noise occur in the 2000, 4000, and 8000 octave bands. If velocity can be reduced, the noise level is reduced. Since air noise power (from several mechanisms) varies approximately as the 5th power of velocity, noise level reduction can be estimated from:

$$\Delta L = 10 \log (V_1/V_2)^5 \quad (3.6)$$

V_1 = Present high velocity

V_2 = Reduced velocity

A free jet impinging on a surface increases the noise level up to 7 dB.

Low noise level jets are available commercially that use a divider at the exit to change a single jet stream into multiple smaller jet streams. These devices should be tested to see if they can do the job required. Some hand air guns use a version of bypass jet engines, in which a mantle of slower moving air is aspirated over the jet. Jet noise reductions of as much as 10 dB can be realized.

If the jet in question is from a vent, it could be moved to be vented outside the plant or it could be muffled.

Air operated tools can be equipped with commercially available exhaust air mufflers.

Hydraulic Systems (Miller, 1973), P.13. Hydraulic systems, as part of a machine or operation, can have specific noise sources. Motor-pump assembly contributes most to the overall noise pattern, being vibrated both by overall vibration and by the blade tooth or piston pass frequency plus harmonics. Noise levels depend on type of pump: gear pumps are more noisy than screw pumps, piston pumps are in between. Noise levels of most pumps increase with speed. Some screw pumps are available that, with a quieted electric motor produce about 81 dBA at 3 ft.

Fluid line noise sources are often sharp bends, flow restrictions, and undersize sections. These configurations cause cavitation and turbulence, causing vibration and noise. The major factors that affect fluid flow and possible noise are pipe diameter, D , fluid velocity, V , fluid density, ρ , and coefficient of viscosity, μ . These parameters are correlated by the Reynolds number, N_R :

$$N_R = DV\rho/\mu \quad (3.7)$$

A Reynolds number of less than 1000 will usually guarantee quiet laminar flow. In general a pipe size large enough to ensure a fluid velocity of less than 10 fps should be used for water-like liquids.

Vibration isolation of the pump-motor unit will attenuate noise from the vibration of the floor. Other noise reduction means include substitution of a larger pump at reduced speed (Figure 3.1); addition of hydraulic mufflers, which may be tuned reactive, untuned reactive, or dissipative. Tuned or side branch mufflers may be used for limited frequency band attenuation for constant speed

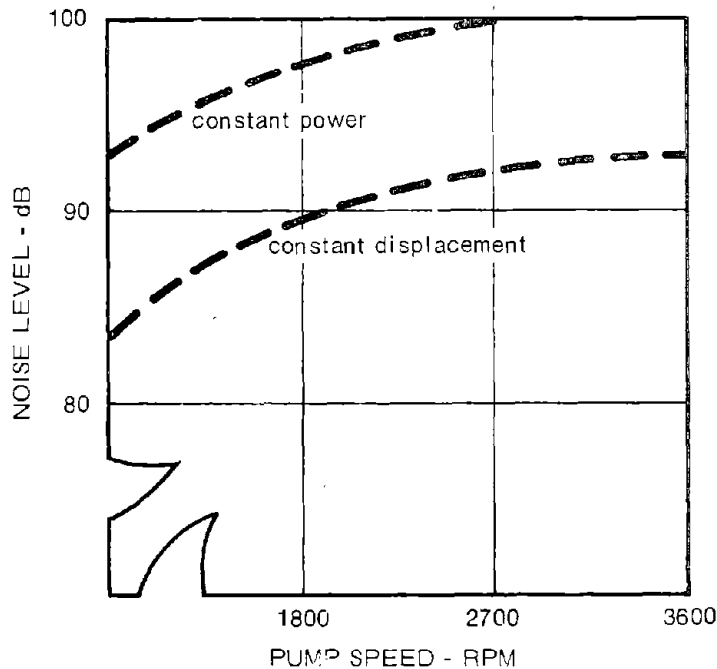

FIGURE 3.1 - Effect of reduced pump speed on noise level

pumps (Figure 3.2). Dissipative mufflers, shown in Figure 3.3, may be used where the diameter d is given by

$$d = 0.014 Q \tag{3.8}$$

where d = Inner pipe diameter, in.
 Q = Flow rate, gal/min

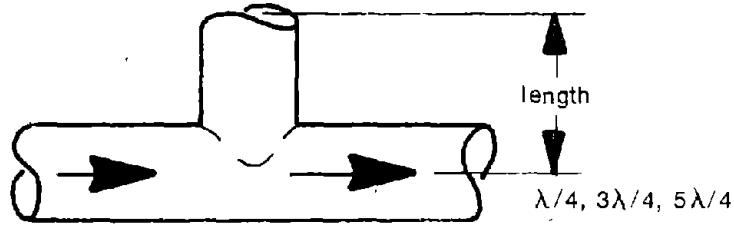

FIGURE 3.2 - Side branch muffler

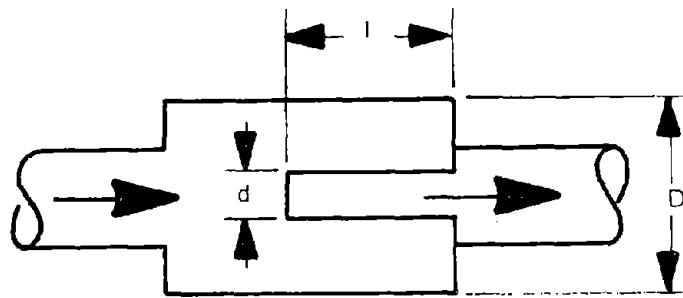

FIGURE 3.3- Dissipative muffler

Chamber diameter, D , and length, l , are determined from:

$$f_c = 0.282 cd/lv \tag{3.9}$$

where c = Velocity of sound, fps

f_c = Cut-off frequency, Hz

$$v \doteq 0.785 \cdot D^2 l$$

Both types of mufflers could be used in the same system for effectiveness over a wider frequency range. Less attenuation is achieved if each is used independently for the specific frequency.

If the pipe size for avoiding turbulent flow is not economical, other means of attenuation must be used, such as storing energy elastically with a flexible hose or surge chamber, use of elastic spacers, wrapping and supporting of the line, use of isolation type hangers, or increase in pipe wall thickness. Noise reductions for several pipe wall thicknesses are shown in Table 3.2.

TABLE 3.2 - A-level noise reduction by use of heavier pipe

Pipe Diameter (inches)	Noise reduction, dB			
	Pipe Grades			
	XS80*	120	160**	XXS
2	6	8	12	16
4	7	10	13	16
6	8	12	15	18
8	9	14	18	19
10	9	15	19	
12	10	16	20	

* Extra heavy

** Double extra heavy

Fluid lines can also be lagged (see discussion of lagging above).

Motor Air Noise. Motor air noise, if found to be a problem, can be reduced by acoustic line air flow chambers which are available for some motors. Totally enclosed fan cooled (TEFC) motors with integral quieting are also being manufactured. Less than 80 dBA at 5 ft is claimed for motors up to 5000 HP.

Enclosed Drives. Vibrating surfaces of a drive enclosure are noise sources. Damping these surfaces reduces radiated noise. If the drive enclosure is a steel box structure, the inside can be lined with a combination absorption layer (such as open cell polyurethane foam) with a damping layer backing. Such materials must be oil-resistant. If there are air vent openings for cooling, noise traps can be added. (For further details see Case History 7 in Chapter 5.) Quieter drives can also be considered, such as substituting belts for gears, "silent" chains for roller chains, and so on. Precision made and carefully aligned gears are always quieter than other types.

Balancing. It is always preferable to reduce noise at the source by avoiding the generation of noise. Unbalanced rotating

parts cause surfaces to vibrate and generate noise. All significant rotating parts should be balanced in situ, that is, in the machine at its final position. This is particularly true for large fans, where there may be unbalanced aerodynamic forces on the blades. Rotating mechanisms that drive reciprocating devices can use counterbalance weights.

Noise Source Enclosures or Barriers. These will be discussed in greater detail in treating the noise path in the next section and are noted here to call attention to the fact that the technique can be used close to localized noise sources. Examples of such sources are drives, pumps, gears, steam and air vents, punch operations (die area), or other localized metal-to-metal contact areas of a machine.

Path of Sound

After as much noise as possible has been reduced at each source, the next step is to reduce noise along the path from the source to the receiver (operator). The sound may be blocked by acoustical shields, barrier walls, partial enclosures, or total enclosures. All these techniques depend on interposing in the path a material, called an isolator, whose wave transmitting properties are as different as possible from those of the path. In air paths, such materials are ideally solid, nonporous, and limp. For liquid paths, a stream of gas bubbles is a good isolator. Along a solid path, resilient vibration isolators perform the same function, weakening the path. Our discussion will be in terms of the most important path, in air.

Acoustical Shields and Barriers. An acoustical shield is an approximately square piece of material, usually (for visual access) safety glass or clear plastic (polycarbonate or polymethylmethacrylate), placed between worker and noise source. Such a shield is effective only if its smaller dimension is at least three times the wavelength contributing most to the noise exposure received. Thus, shields of reasonable size are effective only against high frequency sound, such as from concentrated air or gas jets. Examples include air ejection systems in punch presses, plasma guns, air guns, and metal spray guns. Improperly designed shields can interfere with access. However, they can be combined with automatic safety mechanisms to serve a mechanical safety function as well. A shield must be carefully engineered to the job if maximum noise reduction is to be obtained with minimum interference with manual access. For high frequency noise, reductions up to 8 dB can be obtained. Shields must be vibration-isolated from the machine.

An acoustical barrier is a much larger shield, typically free standing on the floor and usually much wider than high. Visual

access can be provided by viewing ports of safety glass or clear plastic. For both barriers and shields, the sound arrives at the operator around the edges as well as through the material of the barrier. Because the former path most often limits the attenuation that can be obtained, the transmission loss of the barrier material need not be large. Indeed, for the best reasonable barrier, a reduction of 15 to 20 dB in A-level is about the maximum possible. (For a method of barrier attenuation estimating, see Case History 6 in Chapter 5.) Thus, at best the barrier (well-damped) need be no heavier than 0.5 lb per sq ft, if the A-weighted spectrum peaks at 1000 Hz; less may suffice if the maximum occurs at higher frequencies.

For best results, at least the machine side of a useful barrier should be covered with an acoustical absorbent, preferably oil resistant and cleanable. The barrier material can be plywood; it ordinarily needs no added damping, and 1/2 inch will usually be thick enough for a 10-dB reduction. If steel is used, damping must be added to control resonances. Handles and sometimes casters can be provided on the barrier for ease of moving. If the barrier is hinged (for stability), the joints can be severe noise leaks. These leaks can be controlled by a resilient strip of 1/8-inch-thick Neoprene over the gap. Use a width of at least three inches, placed on the concave side of the bend. Fasten by one long edge, with the other free to slide as the hinge bends.

Machine guards for mechanical protection can often be replaced by acoustical guards, covered on the inside by absorbent materials. These guards constitute a type of partial enclosure over the noise source. If visual access is needed, safety glass or clear plastic panels can be used. However, the acoustical guard will have to be more complete than the mechanical, and must be vibration-isolated from the machine. Much engineering must go into fitting the guard so as to cover all the noise leaks. The importance of the leaks can be seen from an example. If the guard is designed for a reduction of 15 dB and has a total area of 6 sq ft, then a crack around it that is about 1/4-inch wide will pass as much sound as the guard material. In most acoustical guards, the leaks will limit the noise reduction possible; the chief task of the noise control engineer is to design for minimum leaks.

When a barrier is wrapped around a machine, with its top more or less open, it becomes a partial enclosure. Such an enclosure can be effective in reducing noise to workers nearby. However, the noise escapes through the top and contributes to the reverberant sound in the workroom. In addition, specular (mirrorlike) reflection from the ceiling can contribute reflected-path levels that can become obvious when the direct path is reduced by the enclosure, as shown in Figure 3.4.

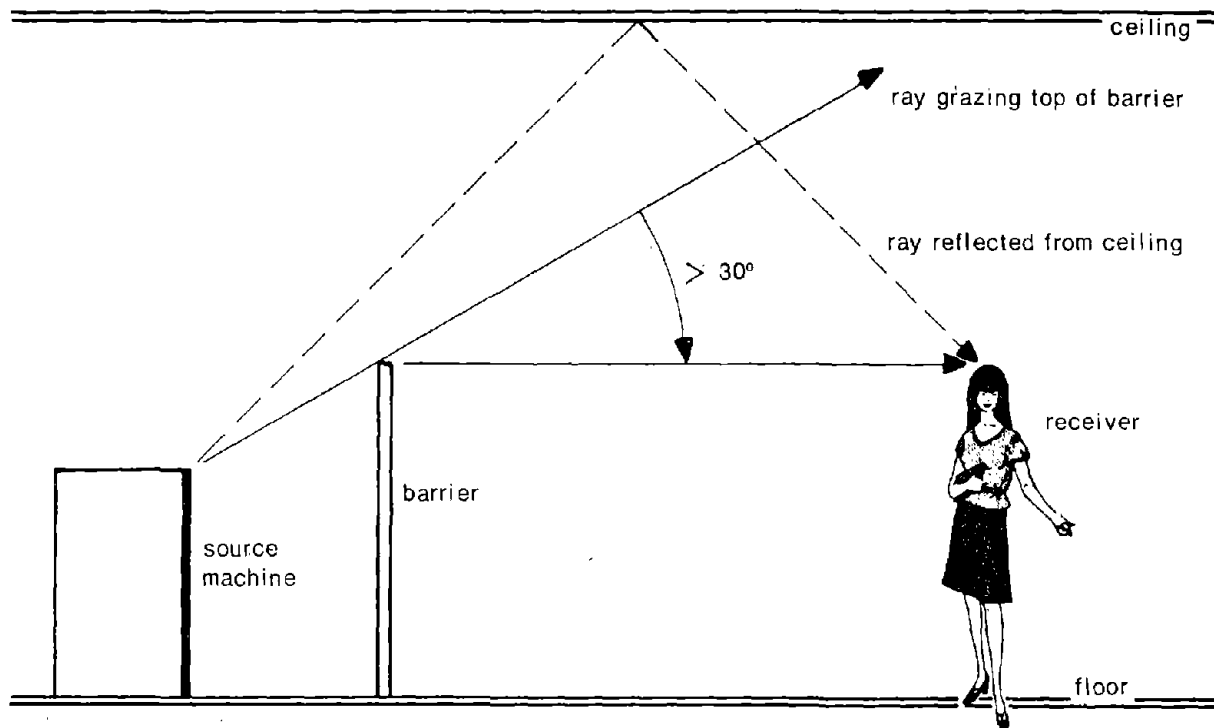

FIGURE 3.4 - Source-barrier-receiver geometry. The angle into acoustic shadow should be greater than 30° for at least 10-dB attenuation. Ceiling reflection can offset barrier attenuation if ceiling height is less than 1.5 times distance from source to receiver.

These spill-over noise effects can be reduced by covering the inside of the enclosure with absorbent. Also, suspended absorbents may be placed over the openings to reduce the escaping noise. If all other machines in the workroom are quieted, then the ceiling reflection may become apparent. Such reflections are usually specular, and the patch of ceiling at which the reflection takes place can be located geometrically on building plans. Absorbent placed on the ceiling at this location will effectively reduce the reflected sound received.

Partial and total enclosures will usually need access for incoming material, product, scrap removal, operator, maintenance person, and vision. Doors, windows, and hatches will handle most access problems, but the usual precautions about avoiding leaks hold strongly at these openings. Hinged or sliding doors can use a gasket for a seal. A convenient material is the closed-cell foamed elastomer weather stripping sold with a pressure-sensitive adhesive. Special acoustical gaskets, designed specifically for sealing leaks, are also available. For less stringent sealing, the magnetic strip gaskets used on refrigerator doors supply both seal and positive closure. Hatches can be dogged down by quarterturn latches.

Windows for visual access may need added internal illumination to make visual monitoring easy and positive. Heat buildup should be no problem with an open top in a partial enclosure. Noise reduction also removes acoustic signals that some workers use in evaluating the performance of a machine. Hence, if the reduction is great enough, acoustic cues may have to be separately supplied. This is easily done by a rugged microphone (at the site where the essential information is generated), feeding a small loudspeaker at the worker position.

Openings for workpiece, product, and scrap flow can permit noise to escape. Such openings should be in the form of tunnels lined with absorbent material. The length of the tunnel determines the amount of noise attenuation obtainable. In the design, the absorbent can be selected for maximum effect on the noise spectrum at that opening. Use of lined tunnels should be accompanied by some degree of automation.

Total Enclosure. The next step of noise control, a total enclosure, has the same problems (and solutions) as the partial enclosure. The chief added problem is that of heat buildup. This problem is easily handled by adding a ventilating blower, together with silencers for both supply and exhaust air. Some internal ducting may be needed if there are heat-sensitive components in the machine, but these ducts can also selectively supply cooling air and remove hot air. The minimum flow rate of cooling air, Q (in cfm) depends on W , the watts of heat generated, and on ΔT , the temperature rise permitted (degree F). For air cooling at sea level, $Q = 1.76 W/\Delta T$. More flow is needed at higher altitudes.

There is no doubt that the total enclosure will require a change in work habits, and as such will usually be resisted by all concerned. The shock of the change can be eased if the people most involved--the workers and the foremen--are provided an opportunity to enter into the design discussions. Enclosures can also force consideration of modernizing equipment, say, for automatic feed by conveyor, so that less personal attention to the machine is required. Such automation may also offset the difficulties that arise from less free access to the machine. In most instances the noise control engineer will have little difficulty with the acoustical aspects of enclosure design. The chief job is to ensure an industrially viable design, taking account of the requirements for access, minimum change in productivity, and minimum installed cost. To meet these requirements, the noise control engineer must work closely with the industrial, plant, and process engineer; with foremen and workers; with maintenance crews; and with management.

As a general matter, enclosures must not touch any part of the machine and should be vibration-isolated from the floor. Nevertheless, the enclosure must be pierced for such services as electricity,

air, steam, water, oil, or hydraulic power. These services can be regrouped, together with mechanical controls, to a convenient location where the enclosure panel can be split. A resilient acoustical seal can then be made from two ring-shaped pieces of 1/8-inch (or heavier) Neoprene. See Figure 3.5. Slot each piece at the pipe or conduit and overlap the two pieces with the slots facing away from each other. Seal the straight edges with strips of Neoprene or similar oil-resistant, heavy, and resilient material.

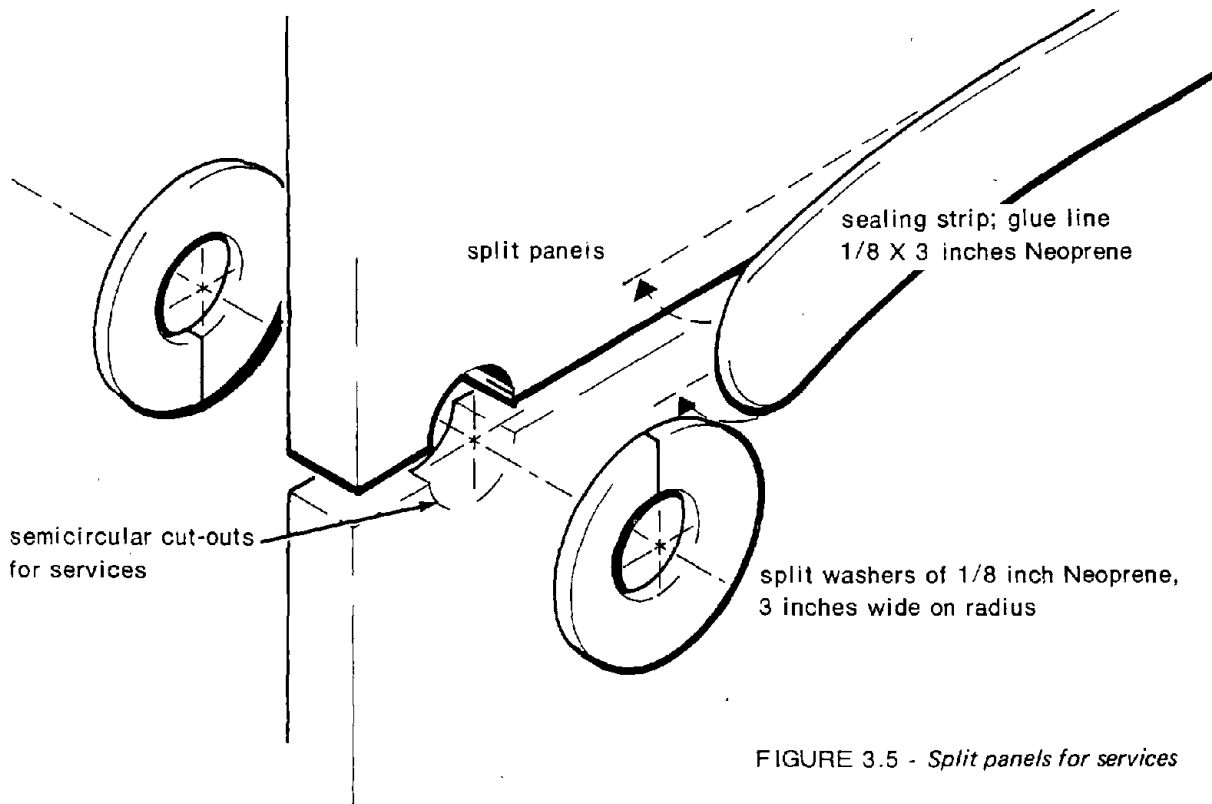

FIGURE 3.5 - Split panels for services

For mechanical controls operating through an arc-shaped hole in a panel, the seal can be of abutted, multiple strips of Neoprene. The control lever should be as thin as possible. Better yet, replace it by a servo control operated from the outside.

Many of the features of a convenient enclosure design are illustrated in Figures 3.6 through 3.13. The general design is based on panels secured (by quarter-turn captive screws) to an angle iron frame (Figures 3.6 and 3.7). Thus, rapid access is provided for all types of servicing of the machine. This type of enclosure is to be as close as possible to the machine. Up to 20 dB of noise reduction is usually easily obtained. The angle iron frame can be of bolted sections, to permit quick and complete disassembly and removal.

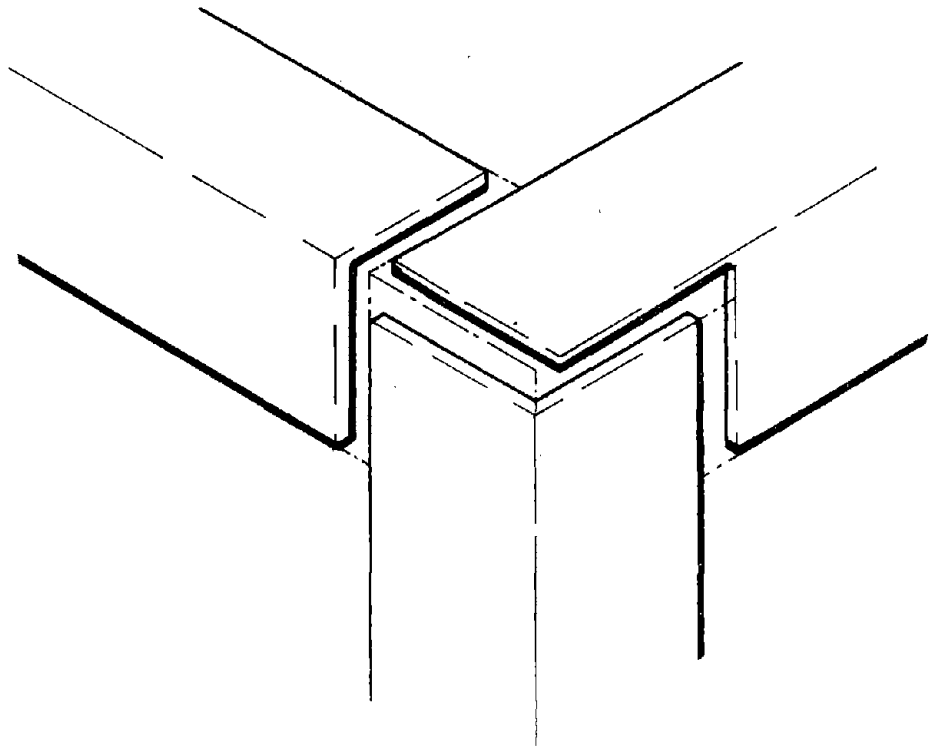

FIGURE 3.6 - Welded angle iron frame. This frame can be welded in segments that are bolted together.

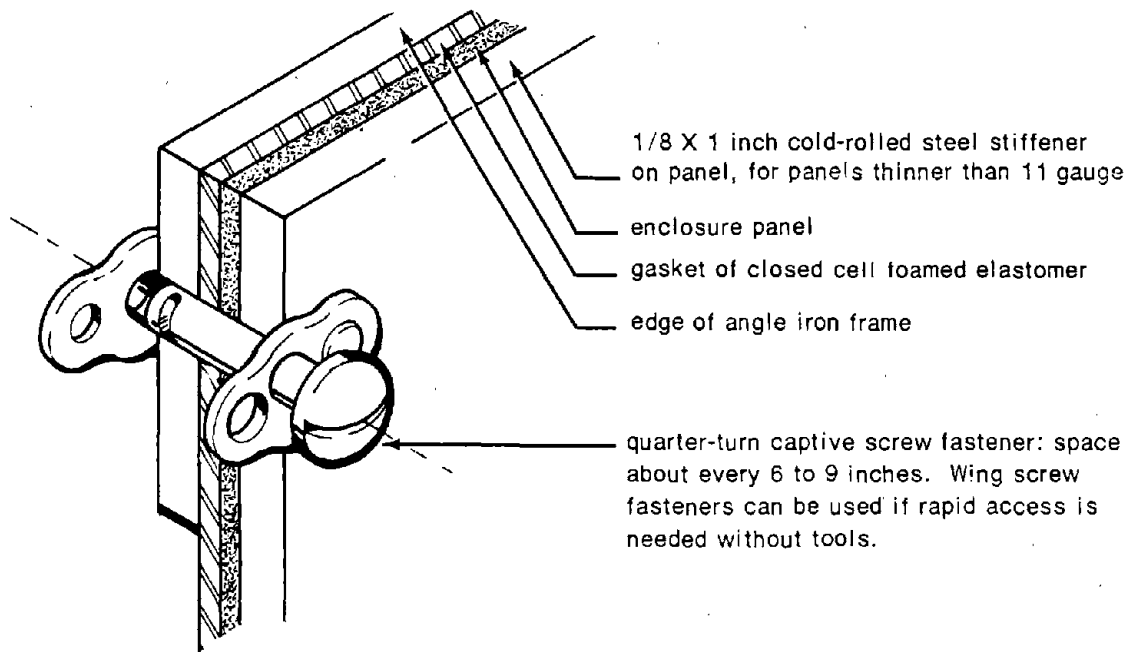

FIGURE 3.7 - Enclosure panels secured to frame by quarter-turn fasteners.

Machine vibration may still create a problem by vibrating the floor, which then acts as a resonant sounding board to vibrate the enclosure. This problem is easily handled by vibration-isolating mounts, using steel springs, or elastomers in shear (Figure 3.8). Special care in design is needed if the exciting force is of short duration but is repeated, as in a punch press. Not all vibration-isolator suppliers recognize the need for careful selection of isolators in this special repeated impact situation. Be sure that you have enough data on the machines and the isolators to ensure an effective design. You will need data on three time scales: (1) duration of the impact, (2) time between impacts; and (3) the minimum period of oscillation of machine on a suggested isolator.

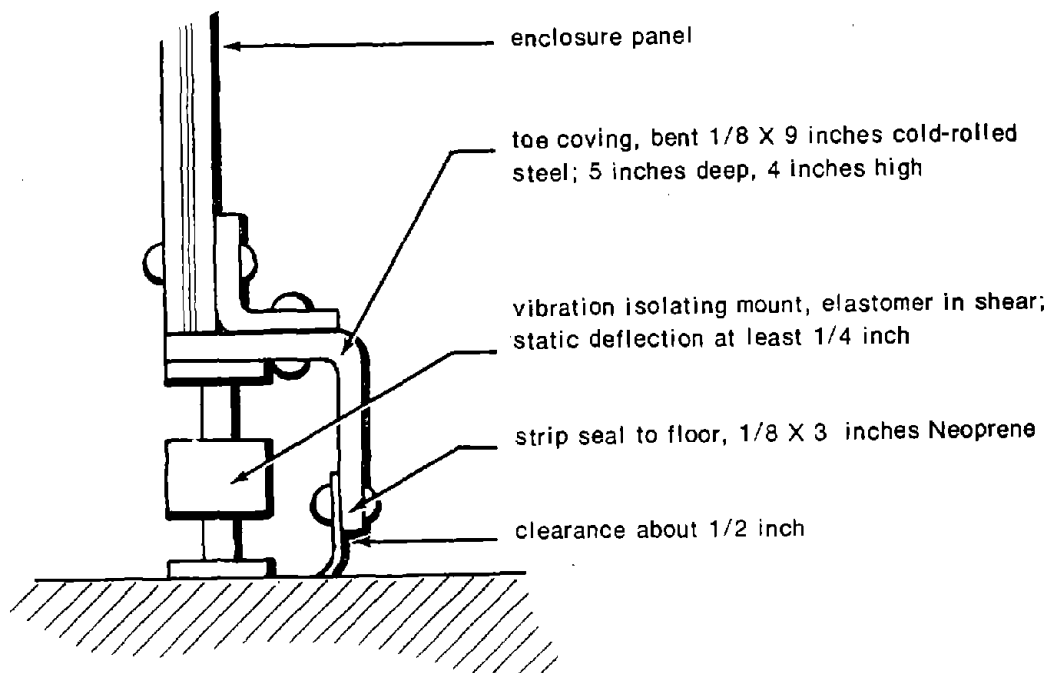

FIGURE 3.8 - *Vibration isolation and toe coving*

In any machine, the time comes when major repairs are due; additions or changes may also be called for. The enclosure design suggested in Figures 3.5 through 3.13 affords some flexibility in this regard. The panels can be made separately and fastened in place with a gasket material (such as weatherstripping) to close off chance leaks. If the panel material is a metal, its resonances can be distributed more uniformly in frequency if the panel is

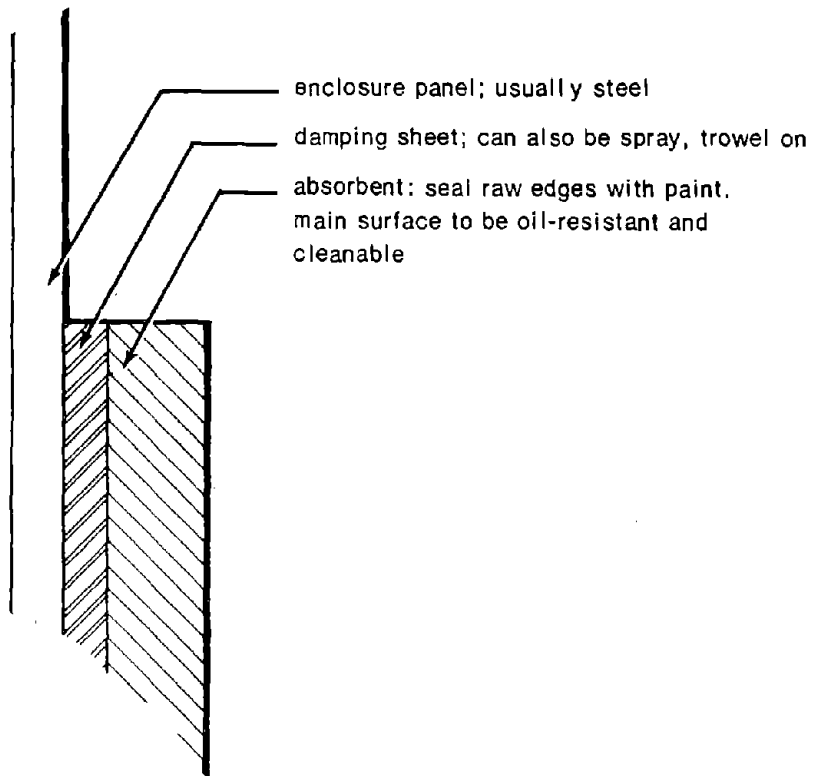

FIGURE 3.9 - Enclosure panel interior treatment

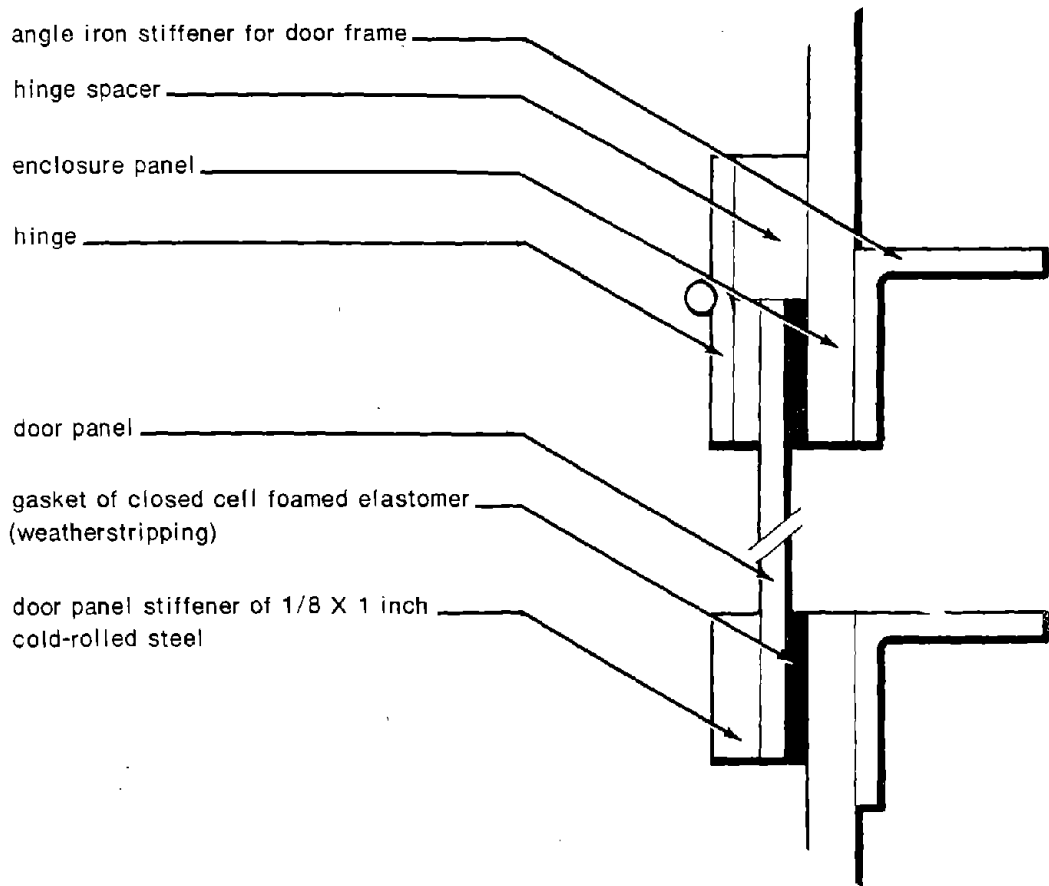

FIGURE 3.10 - Door and hatch detail. Interior of doors and hatches have same acoustical treatment as enclosure panel. Secure doors by vibration resistant latches or by quarter-turn fasteners. Doors and hatches must make airtight seal to enclosure panel.

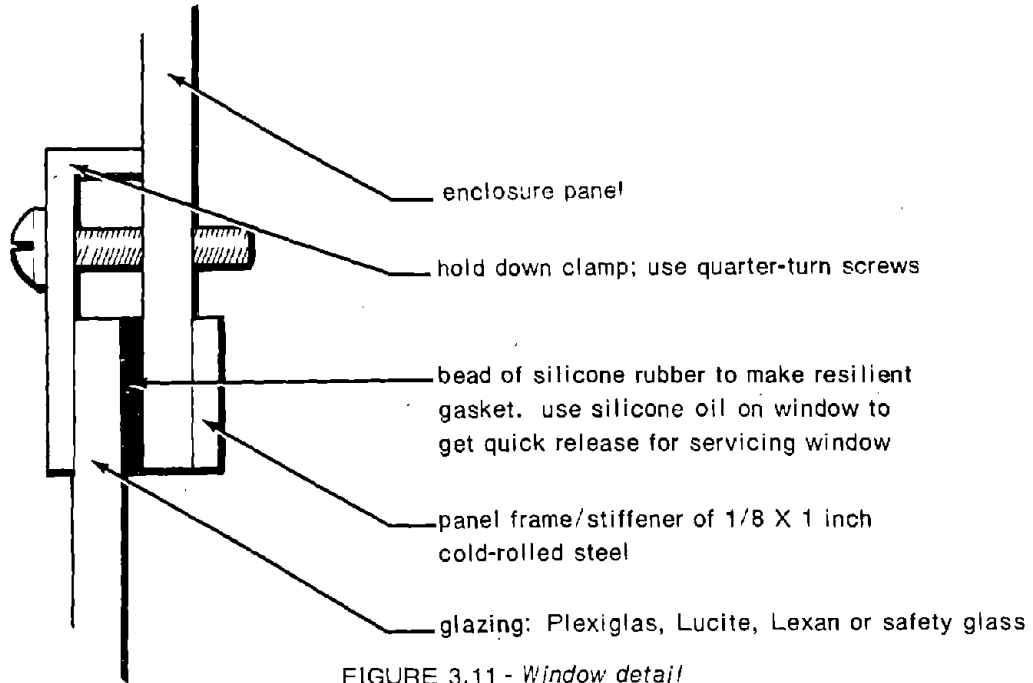

FIGURE 3.11 - Window detail

reinforced by bolted-on angle iron (bolting adds more damping than welding). The stiffeners should be placed so as to divide the panel into smaller areas, no two of which should be the same size and shape. Frames for doors, windows, and hatches can also be used as stiffeners.

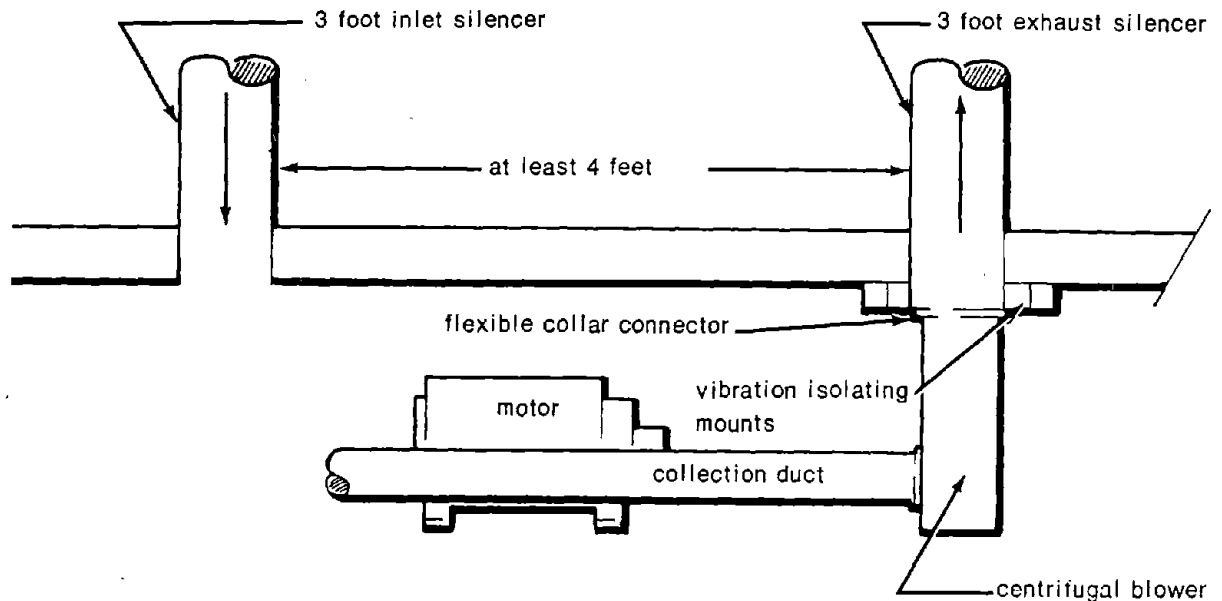
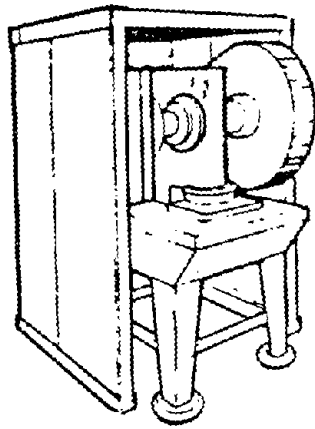

FIGURE 3.12 - Cooling and ventilation system. Three-foot silencers are satisfactory up to 15-dB isolation.

Windows pose a special problem because they are a weak spot acoustically. Generally, if more than 20-dB reduction is needed, double glazing must be used. The inside layer should be safety glass, because it must withstand cleaning to remove oil, grease, and dirt. All panes should be set into soft elastomer gaskets. Room temperature-setting silicone rubbers are useful here. The visual access that windows provide should be carefully thought out in terms of the information the operator needs. Glareless lighting of the components to be monitored is helpful. In extreme cases, closed circuit video monitoring can be used.

A special adaptation of the total enclosure for the machine is a total enclosure for the operator when this is the more practical or economical approach. Such enclosures may require air



partial enclosure

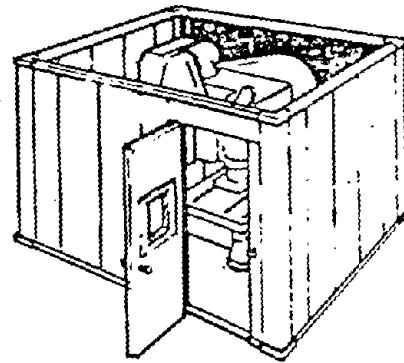

partial enclosure

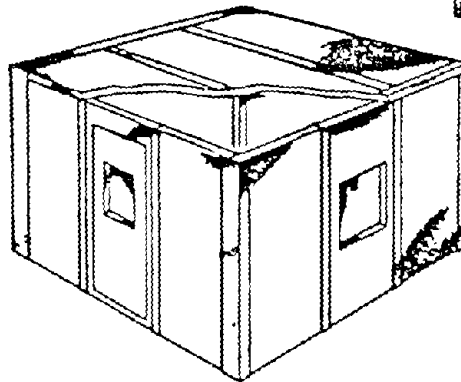
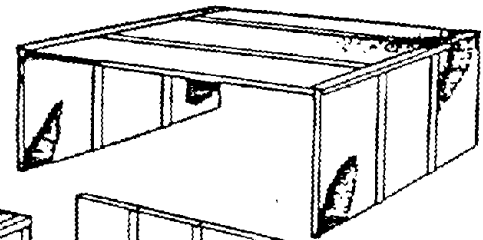
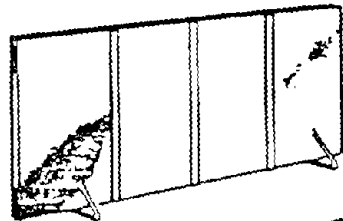

complete enclosure

FIGURE 3.13 - Examples of partial and complete enclosures

intake and exhaust fans, with noise traps, lighting, heating, or in some cases, air conditioning. As in machine enclosures, some inside absorption is recommended, such as an acoustic tile ceiling, and special care must be taken in window and door design to avoid leaks. See Figure 3.14 for effect of leaks.

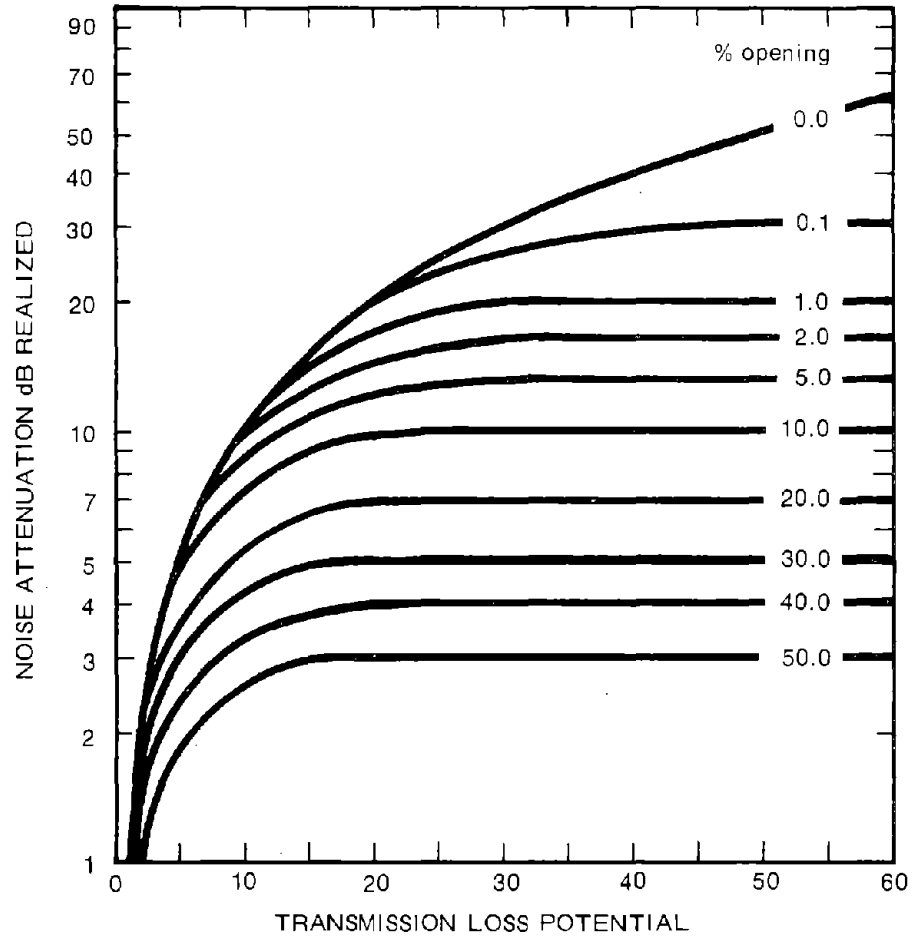

FIGURE 3.14 - Effect of enclosure sound leaks on potential noise reduction

The most important information required for the acoustical design of enclosures is the transmission loss, L_t . This quantity represents, in decibels, the reduction of sound power in going through an isolating wall. It is measured by a well-defined and accepted standard. The transmission loss varies considerably with frequency, and the term sound transmission class (STC) is sometimes used. This is a single number indication of average transmission loss. However, it applies specifically to speech sounds and acoustical privacy requirements. It should be used with caution in industrial situations, where sound spectra differ from those of speech and where reduction of A-level is the requirement. If a single number is needed, use the transmission loss at the band an octave below that for which the maximum A-weighted octave band level occurs at the operator position.

The noise reduction, R_n , is the difference in level at operator and in enclosure after installation of the enclosure. It depends on several factors: the average transmission loss of the enclosure surfaces, the amount of absorption in the enclosure, and to some extent, the acoustics of the work room. The worker is usually close enough to the machine that room acoustics effects are not important. If the average absorption coefficient of the interior of the enclosure is at least 25% at the band an octave below that for the maximum A-weighted octave band level, then approximately $R_n = L_t$. A more useful measure of the effect of the enclosure is the insertion loss. This is the reduction of level at the operator position before and after introduction of the enclosure. Its calculation requires knowledge of total noise power from the machine, its directional characteristics, the total absorption within the enclosure, the transmission loss of the enclosure, the shape of the enclosure facing the worker, and the acoustics of the work-room.

A problem occurs in calculating the net transmission loss when the enclosure has panels, doors, hatches, windows, silencers, and leaks, each with its own area S_i and associated transmission loss L_i . However, a formula which can be used is

$$L_t = 10 \log S - 10 \log \sum S_i 10^{-L_i/10} \quad (3.10)$$

This amounts to adding up all the sound power that escapes and dividing by the total area. As an example consider a machine control room in a corner that has ceiling-high walls that separate it completely from the rest of the shop, where the level is 100 dBA. The design of the wall is shown in Figure 3.15. It is desired to compare the performance of single and double glazed windows at a midrange octave band. We assume that there is negligible leakage through the roof and that all leaks have been well sealed.

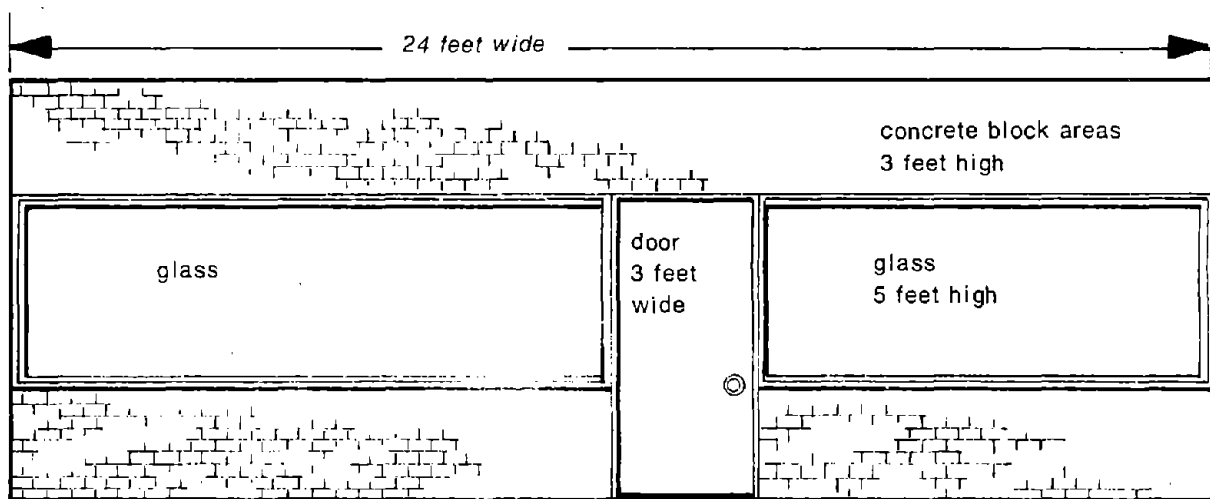

glass area	105 sq ft
door and frame	24 sq ft
concrete block	135 sq ft
total	264 sq ft

FIGURE 3.15 - Example of isolating wall

The calculations can conveniently be put in the form shown below.

	S_i	L_i	$10^{-L_i}/10$	Values of $S_i 10^{-L_i}/10$	
				Single Glazing	Double Glazing
Single Glazing	105	31	7.94×10^{-4}	0.0834	-
Double Glazing	105	45	3.16×10^{-5}	-	0.00332
Door	24	31	7.94×10^{-4}	0.0191	0.0191
Concrete Block	135	45	3.16×10^{-5}	<u>0.00427</u>	<u>0.00427</u>
Sums	264			0.1068	0.0267

$$10 \log 264 = 24.2$$

$$L_t \text{ (single)} = 24.2 - 10 \log (0.1068) = 34 \text{ dB}$$

$$L_t \text{ (double)} = 24.2 - 10 \log (0.0267) = 40 \text{ dB}$$

For the particular octave band for which the above was calculated, the control room levels would be 66 dB for single glazing and 60 dB for double. Note how the single glazed window is the weak element, while with double glazing the door is the chief source of sound entering. Such calculations reveal where improvement may be needed, and how much.

Room Acoustics

In addition to the direct path from the noise source to the receiver (operator), there is also the sound reflected repeatedly from walls, ceiling, and other surfaces, such as equipment. The study of the sound fields generated by such reflections is termed room acoustics.

The sound level from a point source, with no reflecting surfaces nearby, changes at the rate of 6 dB drop per doubling of distance from the source. In a normal factory space with acoustically hard walls, floors, ceilings, partitions, and machines, sound is multiply reflected, and an operator may receive this reflected sound from essentially all directions. The result is a reverberant buildup of noise. This means that as the distance from the machine increases, the noise level will diminish for awhile but a point will be reached where little or no reduction is achieved. Beyond this distance is the reverberant field, and the distance at which the change-over occurs is called the critical distance, r_c . The reverberant field is the only portion of the total noise that is affected by changes in room acoustics. For most industrial situations the operator is inside the critical distance. Thus, the noise that he receives is affected but little by adding absorption to the walls or ceiling of the work room. This absorption will affect the sound level experienced by those who walk through, at some distance from the machines.

The total absorption of a room is the sum of the products of each room area, S , and its associated absorption coefficient, $\bar{\alpha}$. The room constant, R , is a value based on the summation of all areas and is:

$$R = \sum S\alpha / (1 - \bar{\alpha}) = S\bar{\alpha} / (1 - \bar{\alpha}) \quad (3.11)$$

Here $\bar{\alpha}$ is the average absorption coefficient ($\sum S\alpha / S$). As the value of R is increased in a room, the reverberant field sound level is reduced. Figure 3.16 shows relative sound level versus distance from the acoustic center of a noise source, for several values of R .

If we had a single source of noise in a room, which factories normally do not have, the relationship of L_p (sound pressure level), L_w (sound power level), and room constant, R (distance from the

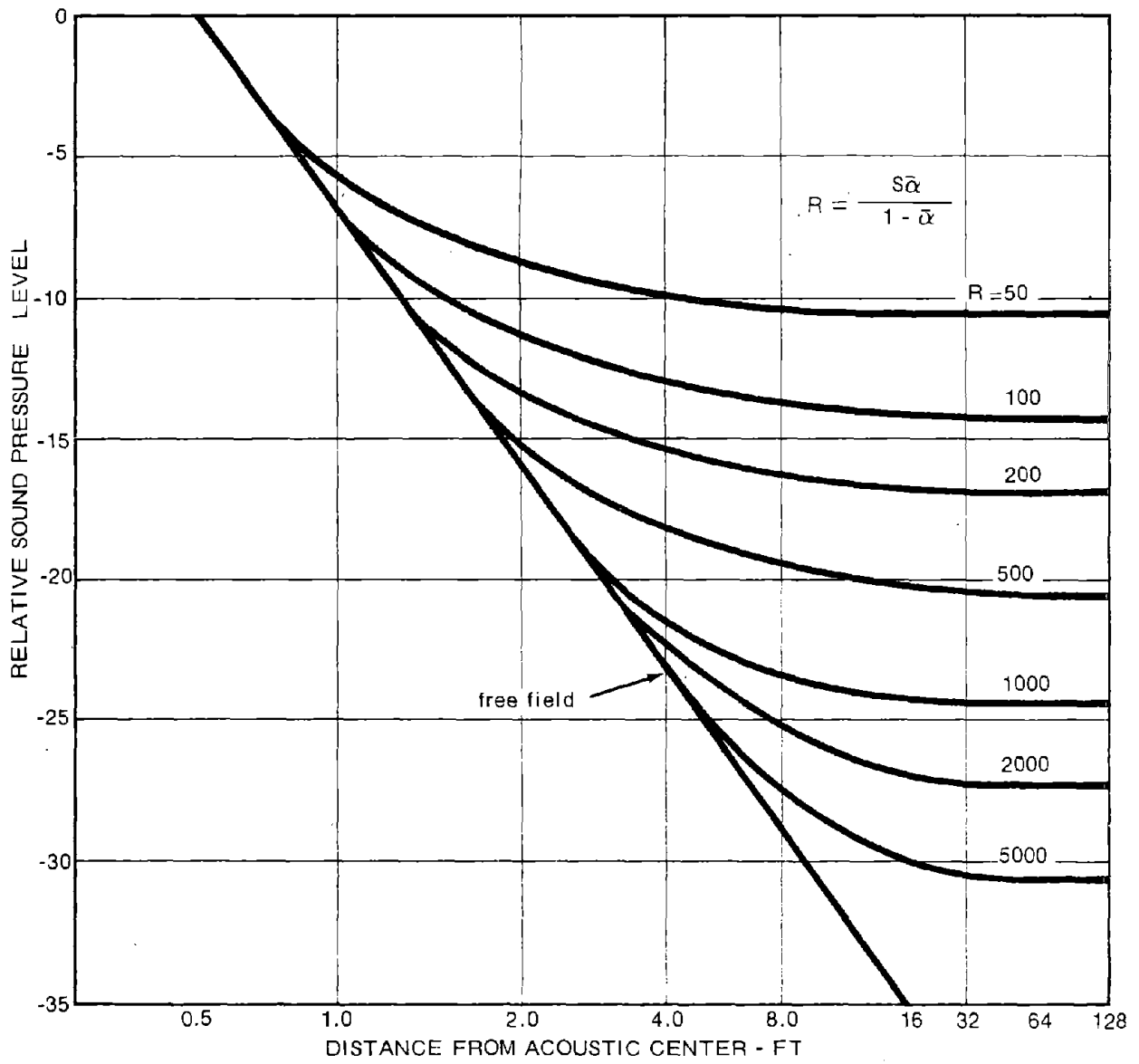

FIGURE 3.16 - Sound field behavior in a reverberant room

noise source, r , is in feet and area, S , is in square feet) is:

$$L_p = L_w + 10 \log \left(\frac{Q}{4\pi r^2} + \frac{4}{R} \right) + 10.3 \quad (3.12)$$

Here Q is the directivity of the source. For r and S in m and m^2 , omit the 10.3.

From this relation, it is seen that the inverse square law and reverberant fields are equal when

$$Q/4\pi r_c^2 = 4/R \quad (3.13)$$

where the critical distance is

$$r_c = \left[\frac{QS\bar{\alpha}}{16\pi(1-\bar{\alpha})} \right]^{1/2} \quad (3.14)$$

where $\bar{\alpha}$ is the average absorption coefficient. For the ordinary factory workroom, $\bar{\alpha}$ in middle frequencies is usually between .05 and 0.1. For machines near a floor, the directivity factor $Q = 2$. Then approximately

$$r_c \doteq 0.2 \sqrt{S\bar{\alpha}} \quad (3.15)$$

If the room has N identical machines,

$$r_c \doteq 0.2 \sqrt{S\bar{\alpha}/N} \quad (3.16)$$

Note that because $\bar{\alpha}$ is usually an increasing function of frequency, the critical distance increases somewhat with frequency.

If a rough estimate of an overall r_c is all that is needed, this can be accomplished by using nothing more than your ears. Focus your attention on a dominant, easily identified noise source. Walk away from the source machine until the level appears relatively constant to your ears. Then walk rapidly toward the source. Stop when you are first aware of an increase in level. Repeat until you have localized the point at which the direct sound begins to predominate, at the critical distance position. Measure from there to the source.

As an example, consider a workroom 80 ft x 120 ft with a 25-ft ceiling, having 10 identical automatic screw machines. Suppose that the average absorption coefficient, at the maximum A-weighted octave band level, is 0.15. Then with a total surface area of 29,200 sq ft,

$$r_c \doteq 0.2 \left[\frac{29,200(0.15)}{10} \right]^{1/2} = 4.2 \text{ ft} \quad (3.17)$$

Workers on screw machines will be within 4 ft, which is just at this critical distance. Hence they will receive about equal amounts of direct and reverberant sound.

If the noise level at a distance from the source requires attenuation, absorption must be added to the room in the form of absorptive materials on ceiling and walls, or by hanging absorbent baffles, which are commercially available. The amount of attenuation needed, ΔL , can be related to room constant R by

$$\Delta L = 10 \log (R_2/R_1) \quad (3.18)$$

where R_1 and R_2 are before and after values, respectively. We again repeat the caution: adding room absorption will normally not reduce the direct noise from the source, which is what the operator receives. Indeed, adding absorption increases the critical distance, so the operator can be still further from his machine and still receive the major amount of noise from it. In the example above, adding 100% absorption would decrease the received level only 3 dB.

Receiver

If noise source corrections and noise path corrections do not reduce the noise to acceptable limits or before these corrections have been applied, attention should be directed toward the receiver. This may be in the form of administrative controls or personal protective equipment or both.

Administrative Controls. Administrative controls can in some cases be developed to limit the duration of exposure to noise levels above 90 dBA to the permissible noise exposure time specified in the Section 1910.95 of OSHA (Occupational Safety and Health Administration) regulations:

<u>Hours/Day</u>	<u>dBA</u>	<u>Hours/Day</u>	<u>dBA</u>
8	90	1½	102
6	92	1	105
4	95	½	110
3	97	¼ or	
2	100	less	115 max.

For combinations of exposures, the sum of the actual daily exposure time divided by the allowed exposure time for each time period must equal or be less than 1.0 to be in compliance regarding noise levels and should be equal or less than 0.5 to reduce the need for wearing ear protectors. The sum of these ratios is called the daily noise dose. Administrative controls include the following approaches:

- (1) Workers at 90 dBA are not exposed to higher levels.
- (2) Workers at higher levels are removed from the noise after the above time limits and spend the balance of the day in lower than 85 dBA areas.
- (3) Work time is divided between more operators, that is, split shifts are arranged between high noise and low noise areas.

- (4) When less than full-time operation of a machine is required, time is split into partial days instead of an occasional full day operation.
- (5) Exposure is reduced by shift scheduling to reduce number of exposed employees and number requiring protective equipment.

Personal Protective Equipment. Present (October 1974) Department of Labor "Guidelines to Occupational Noise Standards" (Bulletin 334), say: "The use of personal protective equipment is considered by the Department to be an interim measure while engineering and administrative controls are being perfected. There will be very few cases in which the use of this equipment will be acceptable as a permanent solution to noise problems."

The Department of Labor Bulletin 334 Guidelines cover the following major points on protective equipment:

- (1) Only approved ear protectors that have been tested in accordance with ANSI Standard Z24.22-1957, should be used.
- (2) Five dB less than stated attenuation of equipment should be allowed because test data were obtained under ideal conditions that are not normal in day-to-day operation.
- (3) Ear muffs and ear plugs should be fitted and supplied through a properly trained person who can educate the workers in the use and maintenance of the muffs and plugs.
- (4) Wax impregnated cotton and fine glass wool are acceptable, but cotton stuffed in the ears has very little value and is not acceptable.

In addition, it is our experience that ear plugs should be inspected periodically to ensure that they have not deteriorated and that the workers have not cut off the ends for greater comfort (but no protection).

Selling the use of protective equipment to employees and supervisors will usually require that an educational and promotional program precede the required use of ear protection. There should be continual follow-up by supervisors to see that the program is accepted and that ear protection is worn where needed. This program can be aided by signs in areas where protective equipment is mandatory. Supervisors should be aware that if a plug or muff is uncomfortable, it may not be worn. Other difficulties are with long

hair, which can hide a plug that has deliberately been loosely inserted; plugs may be cut off and ear muff bands weakened to reduce pressure. Tight muffs over broad-temple glasses can restrict blood flow. Devices are available to ease this last problem.

Audiometry. Audiometric tests should be made of all individuals working regularly in areas in which the noise level is above 85 dBA. This is an excellent way to determine how successful engineering or other controls have been. Several recommendations for an audiometric program include:

- (1) Test facilities and procedures are to meet established standards of ANSI S3.1-1960 and 3.6-1969 (or latest).
- (2) Tests are to be made as described in ANSI standard S3.1-1960 and 3.6-1969, and by a person certified as an audiometric technician by a course of training in accordance with Intersociety guidelines.
- (3) Audiometers used are to meet specifications in ANSI standard S3.6-1969 or latest and shall have a certificate of at least yearly calibration. They are to be subjected to a biological check at least once a month; a log of checks and calibrations is to be maintained.

Chapter 4

NOISE CONTROL MATERIALS

This chapter describes the four types of materials most often used in noise control: absorbers and isolators for airborne sound, and vibration isolators and damping materials for controlling vibration solid-borne sound. Guidelines for selecting materials are also given, based on acoustic and nonacoustic considerations.

By far the best location for noise control is as close to the source as possible. Once the sound is airborne, it is difficult and expensive to control. Control at the receiver by ear plugs, ear muffs, or control booths is not usually included in the meaning of engineering control, which commonly refers to machine-oriented efforts at the source or along the early path.

Absorption Materials

With absorption, sound in air is changed into heat. Suitable materials are usually fibrous, lightweight, and porous. The fibers should be relatively rigid. If a cellular material is used, the cells must intercommunicate. Foams should be reticulated to the proper degree.

Examples of absorbents include acoustical ceiling tile, clothing, loss-type mufflers, and foamed elastomers. Physically the flow resistance of fibrous materials is the most important characteristic. For optimum results, the flow resistance must usually be increased as the thickness of the absorbent decreases, to maintain peak absorption.

The flow resistance can be sensed rather crudely by attempting to blow through the material. Comparison with an accepted material of the same thickness provides a personal calibration. The effectiveness of an absorbent is measured by the absorption coefficient. Ideally, this is the fraction of the sound energy flowing toward the absorbent that enters the material and is not reflected; thus, a perfect absorbent would soak up all the sound incident on it. Industrially useful absorbents have coefficients above 60% in the frequency range from 500 Hz and up.

Absorbents on room surfaces reduce the amount of reverberant sound. The relative reduction of such sound levels by equal amounts of any two absorbents is given approximately by 10 times the logarithm of the ratio of their absorption coefficients. Table 4.1 shows average absorption coefficients of various absorbents, and for comparison Table 4.2 gives absorption coefficients of relatively nonabsorbent construction materials plus those for some special materials.

TABLE 4.1 - Sound absorption coefficients of common acoustic materials

Materials*	Frequency Hz					
	125	250	500	1000	2000	4000
Fibrous glass (typically 4 lb / cu ft) hard backing						
1 inch thick	0.07	0.23	0.48	0.83	0.88	0.80
2 inches thick	0.20	0.55	0.89	0.97	0.83	0.79
4 inches thick	0.39	0.91	0.99	0.97	0.94	0.89
Polyurethane foam (open cell)						
1/4-inch thick	0.05	0.07	0.10	0.20	0.45	0.81
1/2-inch thick	0.05	0.12	0.25	0.57	0.89	0.98
1 inch thick	0.14	0.30	0.63	0.91	0.98	0.91
2 inches thick	0.35	0.51	0.82	0.98	0.97	0.95
Hairfelt						
1/2-inch thick	0.05	0.07	0.29	0.63	0.83	0.87
1 inch thick	0.06	0.31	0.80	0.88	0.87	0.87
* For specific grades see manufacturer's data; note that the term NCR, when used, is a single term rating that is the arithmetic average of the absorption coefficients at 250, 500, 1000, and 2000 Hz.						

TABLE 4.2 - Sound absorption coefficients of common construction materials

Material	Frequency Hz					
	125	250	500	1000	2000	4000
Brick						
Unglazed	0.03	0.03	0.03	0.04	0.04	0.05
Painted	0.01	0.01	0.02	0.02	0.02	0.02
Concrete block, painted	0.10	0.05	0.06	0.07	0.09	0.08
Concrete	0.01	0.01	0.015	0.02	0.02	0.02
Wood	0.15	0.11	0.10	0.07	0.06	0.07
Glass	0.35	0.25	0.18	0.12	0.08	0.04
Gypsum board	0.29	0.10	0.05	0.04	0.07	0.09
Plywood	0.28	0.22	0.17	0.09	0.10	0.11
Soundblox concrete block						
Type A (slotted), 6 inch	0.62	0.84	0.36	0.43	0.27	0.50
Type B, 6 inch	0.31	0.97	0.56	0.47	0.51	0.53
Carpet	0.02	0.06	0.14	0.37	0.60	0.65

The absorption coefficient depends not only on the material but also on what is in front and back of it. Most coefficients are stated for an unobscured front, but with a rigid impervious backing spaced various distances away from the material. Noise control engineers use designations of the Acoustical and Insulating Materials Association to describe the material mountings:

- (1) Cemented to backing with about 1/8 in. air space
- (2) Spaced 3/4 in. away by furring strips
- (4) Laid directly on surface - very little air space
- (7) Suspended 16 in. from the backing

When the mounting is not specified, usually it is No. (1) or (4).

Materials may have special facings. For resistance to grease and water that would clog pores, a thin plastic film covering is often used. Such films, as well as perforated hardboard facings, tend to produce a maximum in the mid-frequency absorption coefficient. Some thin construction materials, notably plywood, can show increased low frequency absorption by panel resonance, if they are not securely fastened down.

The standard reverberation room method of measurement of absorption coefficient (ASTM C423-66, or latest version) essentially subjects the absorbent to sound from all angles. Data on absorption coefficient cannot be regarded as useful and meaningful unless they have been obtained in this standard fashion.

Often a single-number statement of average absorption is needed. Not always useful to the noise control engineer, but at least standardized in presentation is the noise reduction coefficient (NRC). This is the average, to the nearest 0.05, of the coefficients at 250, 500, 1000, and 2000 Hz.

Transmission Loss Materials

The noise isolation properties of materials are stated in terms of transmission loss. As with absorption, the concept of energy flow is used; here it is the energy transmitted through the material, relative to that flowing toward it. Transmission loss is $10 \log$ (incident)/(transmitted energy), and usually increases with frequency at the rate of 6 dB per doubling of frequency. Measurement is difficult, and only a handful of laboratories in this country are qualified to make the standard measurement (ASTM E90-61T, or latest revision). Data on the transmission loss of materials appearing in advertising literature cannot be regarded as meaningful unless they have been determined in this standard manner.

As a result of the search for a single number to indicate the average full transmission loss, the concept of sound transmission class (STC) was developed. It is useful specifically in assessing the degree to which intelligible speech is prevented from being transmitted through a wall. Because the intelligibility of speech depends chiefly on the higher frequency sounds, the STC is arrived at by requiring greater loss at higher frequencies than at low. The STC should be used with caution in industrial work, however, where the noise spectrum can be much different from that of speech. The noise control engineer will need the transmission loss in each octave band for the proper application of isolating materials.

Isolating materials are effective because the material is as different as possible from air, on a wave-transmitting basis. In many situations where a large transmission loss is needed, the materials can be installed in several layers, rather than one thick one. The chief requirement is that there be minimum mechanical connection between layers, other than the air space. Large increases in transmission loss are possible by subdividing the total mass.

Damping Materials

Damping materials are used to reduce resonance effects in solids. Essentially, damping materials are absorbents for solid-borne sound and convert it into heat.

Damping materials are used in many applications. If a machine panel (such as a belt guard) is subjected to vibration, it will radiate sound strongly at its resonant frequencies. Damping the panels or guards can thus reduce this radiated sound. In another application, parts that fall into (and are carried along) metal chutes can excite the chute panels by repeated impact. Damping materials along the chute surfaces will reduce the noise; these materials must also be selected with heat resistance and mechanical integrity in mind. Damped stock tubes are available for quieting screw machine operation. Panels for isolating enclosures can transmit large amounts of sound in the critical frequency region. Damping can greatly reduce the severity of the decrease of transmission loss in that region.

There are two types of damping materials: homogeneous and constrained layer. A homogeneous material is applied in a relatively thick cast, sprayed or troweled layer, depending on the thickness and type of metal to be damped. A constrained layer material consists of a thin layer of the actual damping (lossy) material, with a backing of thin metal or stiff plastic. The mechanical action is one of making the damping layer much more effective than if it were homogeneous. Constrained layer damping materials can be purchased as an adhesive/metal foil tape combination, where the adhesive is selected for its energy loss properties as well as its adhesion. These damping tapes are especially useful on thin panels (1/16-in. steel or less).

Vibration Isolators

Vibration isolators act on the same principle as isolators for airborne sound: introducing into the transmission path a material whose wave-transmitting properties are as different as possible from the medium carrying the wave. For vibration in solids, such materials are spring-like. Examples include resilient elastomer and metal springs, elastomer pads, and in extreme cases, air springs. The weaker the spring, usually the greater the isolation.

Solid rubber or rubber-fabric pads are not too effective, because the displacement is small and is not proportional to the load. This latter effect, called nonlinearity, is best described by a curve showing load on the isolator to produce a given deflection. Some manufacturers provide these data.

If an isolator is too weak vertically, it may not be laterally stable. There are available side-restrained metal spring isolators to avoid this difficulty. In extreme cases it may be necessary to use many isolators, all acting along lines that pass through the center of gravity of the machine. This use of materials is most effective when the vibration situation is reversed, i.e. when a delicate mechanism is to be protected from external shock and vibration.

The proper amount of damping is needed with vibration isolation in many applications. Steel springs alone are highly undamped; if they rest on elastomer pads, there is much improvement.

Material Selection

The most commonly used materials for control of noise in industry are isolators and absorbers for airborne sound and vibration isolators and dampers for solid-borne sound. Selection of materials is governed by many factors other than acoustical, and installed cost becomes less important than possible interference with production. Here we first discuss the acoustic factors and then consider the others.

Acoustic Considerations. Isolators for airborne sound have many configurations, ranging from a simple shield to a barrier to a total enclosure. The most important acoustical parameter is the weight per unit area: the heavier the barrier, the more isolation is obtained. A characteristic of most isolating materials, such as sheet steel, glass, or solid wood panels, is that they are resonant. At the frequencies for which the various types of resonances occur (and particularly in the coincidence region), the isolation afforded becomes much smaller. At frequencies above the resonance, the isolation again increases.

An idealized and smoothed way of describing the above behavior is given by Beranek in Noise and Vibration Control (B.5). Isolation, expressed (in dB of transmission loss) as the ratio of energy transmitted to energy incident, first increases with frequency at the rate of 6 dB per octave. At the coincidence region, a plateau is reached for which the average transmission loss is practically constant (see Table 4.3). The frequency extent of this plateau depends on the damping, or deadness, of the panel material. Thus, lead has a short plateau and steel a long one. Above the plateau, the isolation again increases. Damping can be added to reduce the plateau length.

TABLE 4.3 - Transmission loss of common materials

Material	Frequency Hz							
	lb/sq ft	125	250	500	1000	2000	4000	8000
Lead								
1/32-inch thick	2	22	24	29	33	40	43	49
1/64-inch thick	1	19	20	24	27	33	39	43
Plywood								
3/4-inch thick	2	24	22	27	28	25	27	35
1/4-inch thick	0.7	17	15	20	24	28	27	25
Lead vinyl	0.5	11	12	15	20	26	32	37
Lead vinyl	1.0	15	17	21	28	33	37	43
Steel								
18-gauge	2.0	15	19	31	32	35	48	53
16-gauge	2.5	21	30	34	37	40	47	52
Sheet metal (viscoelastic laminate-core)	2	15	25	28	32	39	42	47
Plexiglas								
1/4-inch thick	1.45	16	17	22	28	33	35	35
1/2-inch thick	2.9	21	23	26	32	32	37	37
1-inch thick	5.8	25	28	32	32	34	46	46
Glass								
1/8-inch thick	1.5	11	17	23	25	26	27	28
1/4-inch thick	3	17	23	25	27	28	29	30
Double glass								
1/4 x 1/2 x 1/4-inch		23	24	24	27	28	30	36
1/4 x 6 x 1/4-inch		25	28	31	37	40	43	47
5/8-inch Gypsum								
On 2 x 2-inch stud		23	28	33	43	50	49	50
On staggered stud		26	35	42	52	57	55	57
Concrete, 4-inch thick	48	29	35	37	43	44	50	55
Concrete block, 6-inch	36	33	34	35	38	46	52	55
Panels of 16-gauge steel, 4-inch absorbent, 20-gauge steel		25	35	43	48	52	55	56

Figure 4.1 shows the plateau average height and width for some common single panel isolating materials. Note that the variable is the product of frequency and weight/area (abbreviated as fw and given in Hz-lb/ft²). To select material and weight/area, first decide how much noise reduction is needed. A good approximation is obtained by measuring the octave band spectrum and A-level at the ear position of the worker closest to the machine. If this position is indefinite, measure at 1 meter (3.28 feet) from the major noise-producing surface of the machine. Then the minimum noise reduction, NR, needed is given by:

$$NR = L_A - L_C \quad (4.1)$$

where L_A is the equivalent 8-hour level, and L_C is the criterion level of 90 or 85 dBA, as appropriate. It is wise to plan for 85 dBA. The transmission loss (TL) for industrial situations is related to the noise reduction by $TL = NR - 6$. To afford design margin, it is wise to use $TL = NR$.

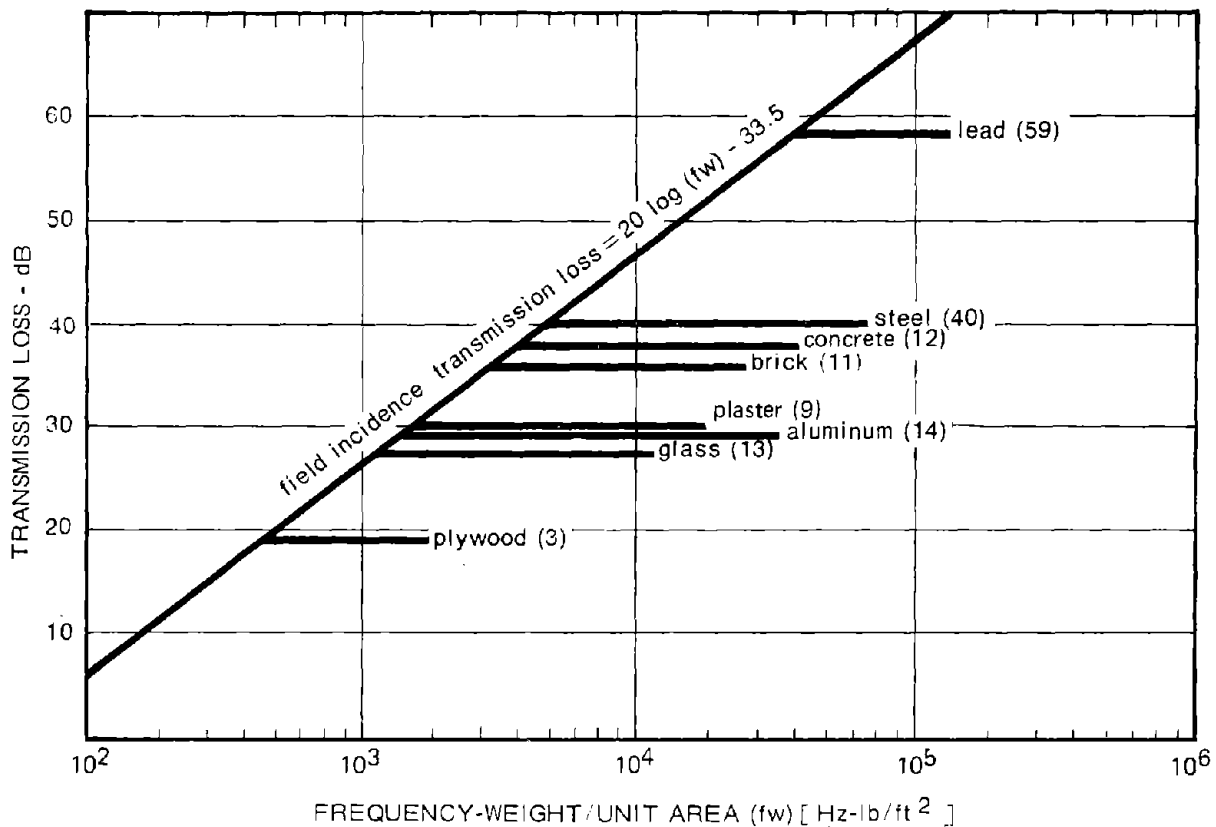
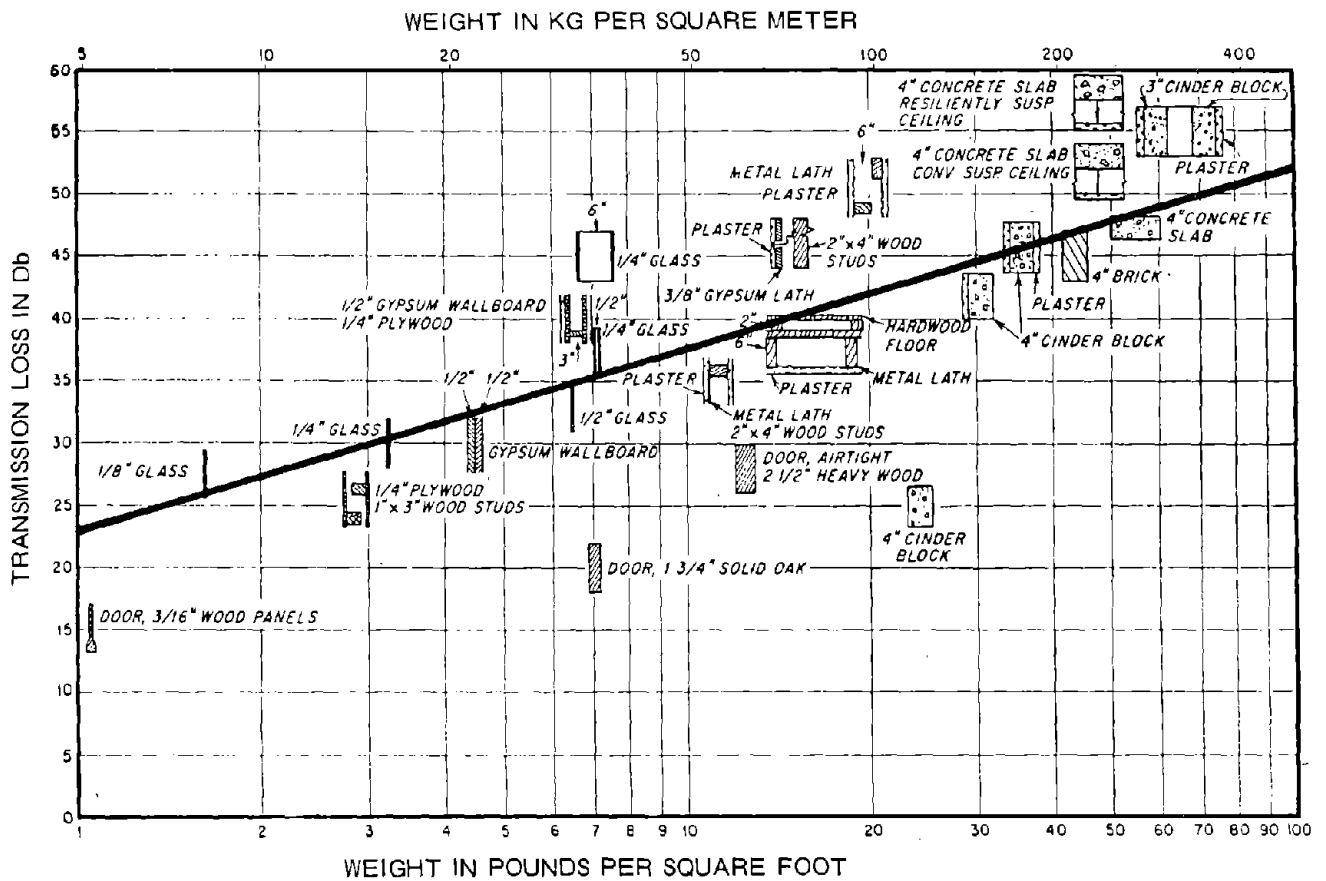

FIGURE 4.1-Transmission loss plateaus. Ends of plateaus occur at the following fw values: plywood 500, 2600; glass 1200, 13,000; aluminum 1400, 25,400; plaster 1400, 11,200; brick 3500, 12,250; concrete 4000, 18,000; steel 4500, 49,500; lead 30,000, 120,000. Numbers in () are weights in lb/sq ft per inch of thickness.

The next question is: In what octave band is the maximum noise reduction needed? To estimate this, modify the measured octave band levels by subtracting from each its midband A-weighting. Locate the octave band in which the maximum A-weighted level occurs. Use the designating frequency of the octave band below this in calculating the weight.

Now use Figure 4.1. Choose a material whose plateau height is greater than TL required. If the plateau is too low, added damping will be needed to avoid extreme coincidence effects. From the curve, find the value of the fw (frequency X weight/area) product corresponding to the TL needed. Divide this fw product by the designating frequency of the octave band below the maximum in the A-weighted octave band spectrum. This gives the minimum weight per unit area for the panel material. See Table 4.3 for the TL of some common materials and Figure 4.2 for a comparison of various materials and wall designs (from Harris 1957, p. 20-6), B.7.



Source: C.M. Harris, ed., *Handbook of Noise Control*, McGraw-Hill, New York, 1957.

FIGURE 4.2 - The mass law relation between average sound transmission loss and mass per unit area of partition

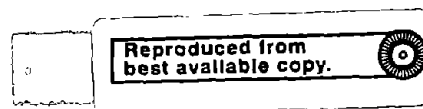

If the panel material is resonant (long plateau), it must be damped to reduce plateau length. For irregular panels, the damping material can be sprayed on or troweled on. As a convenient guide, several popular materials are satisfactory when the dry thickness of the damping treatment is about twice that of base metal, usually steel. Manufacturers will furnish recommended treatment thickness.

Design recommendations based on this material selection are covered in more detail in Chapter 3.

Many damping materials are quite temperature-dependent. Be sure that the material selected has optimum performance for the temperature range in which it will be used. Most manufacturers can supply the necessary engineering information for making an optimum selection. Damping materials in sheet form for gluing to a vibrating surface can be supplied with a pressure-sensitive adhesive.

The interior of enclosures must be sound absorbent to prevent reflective buildup of sound within the enclosure. Often the functions of absorption and damping can be combined in a single composite material. The absorbent is usually a foamed polyurethane; the minimum thickness of the foam should be 1 inch. Special oil and water-impervious film coverings can be specified. This covering protects the material from becoming liquid soaked. However, deposits on the film must be removed periodically to prevent loss of high frequency absorption. Use a mild warm detergent solution, applied with a cloth. Wipe carefully to prevent damage to the film.

Absorbents protected by a film still have exposed edges. These may be sealed by a latex paint that anchors itself to the pores of the absorbent and closes the edges. An alternative is a thin film that is adhesively fastened over the edges. By choice of thickness of air space between the absorbent and the mounting surface, the shape of the absorption-frequency curve can be controlled. This can be matched to the need for maximum noise reduction in frequency regions determined by the noise measurements.

Vibration Isolators. The selection of vibration isolators is based on placement of the resonance frequency of both machine mass and isolator spring constant. All of these should be well below the operating frequency. As a general rule, a machine on a heavy rigid foundation is well isolated when the resonance frequency is less than $1/5$ the lowest operating frequency. The latter is usually that of rotary unbalance in the slowest rotating part. If the machine is on a lightweight floor or is hung from a springy roof, the ratio should preferably be less than $1/5$. Vibrating pipes or suspended fans can be in this category. Steel spring pipe hangers, supplied with damping elastomer seat, are the usual pipe hanger materials selected. For many machines on a solid foundation, a crossribbed rubber pad often suffices. Manufacturer's literature can be helpful in making an optimum selection, provided that the spring constant and maximum deflection is supplied.

A special problem arises with punch presses or other sources of periodic impulse noise. Here the problem is to reduce the transmission of both the shock and the ensuing vibration. The optimum choice of vibration isolator is governed by the relation among three time intervals. First is t_1 , the effective duration of the exciting shock. Second is t_2 , the period (time for one cycle) of motion resulting from resonance between mass of the machine and the effective stiffness of the vibration/shock isolator. Third is t_3 , the interval between repetitions of the impulse. The isolator should be chosen so that $t_1 < t_2 < t_3$ to obtain near-optimum results. The value of t_1 for a punch press or shear is approximately the time between contact of the tool with the workpiece and the completion of the cutting action. This can be determined from machine parameters; direct measurement with an oscilloscope gives more reliable data.

Vibration isolation can reduce A-levels from 2 to 15 dB. The lesser amounts are obtained when the base is solid and heavy, as for a foundation set directly on the earth. See Chapter 3 for more detailed discussion of vibration isolation.

Silencers. Silencers or mufflers can be considered as sections of a duct or pipe that have been acoustically designed and treated or shaped specifically to reduce the noise transmission. The noise may originate from a machine, or be flow-generated by gas or liquid flow.

Silencers for airborne sound are best selected by reference to manufacturers' literature. The usual silencers are lined with special absorbents. The reductions available are tabulated for the octave bands for several silencer lengths. Knowing the reduction desired, you can choose readily. Silencers are often available in several pressure drop categories. Final selection requires some expertise in air-handling system design, and a mechanical engineer should be consulted in critical situations. The degree of silencing also depends on the amount of steady flow and on whether the sound is traveling upstream or down. Some manufacturers supply such data.

Nonacoustic Considerations of Materials. Selection may also require consideration of nonacoustic factors, which often control the final choice. These factors may be broadly classified as environmental and regulatory. Environmental factors include:

- Moisture, water spray, water immersion
- Oil, grease, dirt
- Vibration
- Temperature
- Erosion by fluid flow.

Regulatory factors include:

- Lead-bearing material forbidden near food processing lines.
- Restrictions on materials that may be in contact with foods being processed - glass, monel or stainless steel permitted.
- Requirements for material not to be damaged by disinfecting.
- Firebreak requirements on ducts, pipe runs, shafts.
- Flamespread rate limits on absorbents.
- Fire-endurance limits on absorbents.
- Restrictions on shedding of fibers in air by absorbents.
- Elimination of uninspectable spaces in which vermin may hide.
- Requirements for secure anchoring of heavy equipment.
- Restrictions on hole sizes in machine guards (holes can reduce radiated noise of vibrating sheets).

A good example of the influence of these factors is seen in the selection of absorbents for use inside machine enclosures. It is typical of ordinary maintenance practice to over-lubricate rather than to install or service oil or grease seals. Hence it is common to find oil and grease deposits on machines, often with dirt, metal chips, and other debris. Such deposits greatly degrade the performance of absorptive coatings, which are porous materials that easily wick oil and water. However, absorbent materials are now available with a thin imperforate skin or film covering of Mylar, Saran or Tedlar, which prevents fluid wicking. Nevertheless, the sheer weight of grease deposits will degrade higher frequency performance even without wicking; fire hazard will also be increased. Hence the film must be strong enough that the deposits can be cleaned off with a cloth wet with warm detergent, plus mild rubbing. Such maintenance will be necessary with machine enclosures lined with absorbent. The time between cleanings can be greatly lengthened if oil and grease seals are installed or if deflecting shields are used on severe oil spray, such as comes from impacting parts in a punch press.

Certain types of isolating materials are convenient for constructing an enclosure rapidly. The usual material is lead-loaded vinyl plastic. Where leaded materials cannot be used, as in some stages of food processing, a barium-loaded type is available. Monel and stainless steel are the only common metals usually permitted in contact with food. Fibrous absorbents in shop-made silencers and mufflers can be eroded by high speed gas flow, say, above 30 m/s (100 fps). The fibers may pose a health hazard and also can interfere with machine operations. The situation is worsened if vibration is present, as this tends to break and shake out small fibers. The material used should have some bonding agent to hold fibers securely in place. In addition, the absorbent can be covered with wire screen or perforated metal. If the latter is used, the ratio of open to total area should be over 0.5. The effective absorption will be decreased if lesser open areas are used. Foamed absorbents shed much less than fibrous types, but all need sealing of raw edges by a film-making paint or by a thin plastic cover.

Since most damping materials are very temperature sensitive, the operating temperature must be known before making an informed selection. For unusual conditions, consult the manufacturer. Often if a large lot of material is to be purchased, it can be specially formulated for the conditions specified.

Fire resistance is often required by building codes. Absorbents are available for several degrees of resistance. With suitable materials, fire breaks are sometimes unnecessary in isolating walls that are filled with absorbent. Since local building codes may not be applicable to structures that can be described as a part of the machine, prudent language must be used in describing the function of the enclosure.

A most important nonacoustical factor in the selection of noise control materials is net cost. The noise control engineer must always be aware of this and should design so that labor plus materials cost is minimized. A part of the net cost is also the loss in production while a machine is being treated, so time to restore production must be considered. Ease of maintenance must also guide the selection. Achieving a viable design means that material selection cannot be accomplished on a purely acoustical basis.

Chapter 5

CASE HISTORIES

The case histories presented here should be of some use to production and safety engineers, health personnel and other factory personnel who are not specialists in noise control. The case histories are examples of engineering tasks that have been completed by professional noise control engineers. Collected here are actual cases on various industrial devices. These devices were typically machines utilized in a production process and in some cases had been cited by safety officials for unsafe high noise levels.

The case histories presented here were chosen from some of those where the amount of noise reduction actually achieved was measured. Such engineering results, even if not directly applicable to your situation, may illustrate general principles that will point the way to a successful result in your problems.

Each case history was selected because the work stations associated with it were in violation of the recommended noise exposure levels in all but two or three examples, where uncomfortable noise levels affected productivity even though they were lower than the limits in the OSHA noise regulations.

Case History Data

Ideally, case histories should be complete in all details. However, the prime duty of a practicing noise control engineer is to solve his client's problems at minimum net long term cost. In this the experience of the noise control engineer is invaluable in knowing when information is unnecessary or has been handled verbally. Indeed, the client may already have done part of the work.

In the following outline, there is described the whole process of accomplishing noise control that is viable in both engineering and economic senses. The outline will also serve as a check list to guide you in learning and applying the principles of noise control engineering that have been discussed earlier. The case histories that follow contain the essential data for the simpler problems and somewhat more for the complicated ones.

Outline of Complete Procedure for Development of Noise Control

1. Plant data

- SIC classification of industry
- Location, address; division
- Product or process

2. Problem definition

- Compliance plan
- Compliance measurements, daily noise dose
- Diagnostic measurements and source locations
- Design of experimental noise control
- Design of final noise control
- Supervision of construction, installations
- Post-installation checkout, performance evaluation
- Oral briefings
- Preparation of technical paper

3. Machine data

3.1. Identification

- Make, model, serial number, factory number
- Appearance (drawing or photo); identification of significant parts, functions
- Layout drawing of workroom, all machines shown
- Location of aisles, vertical clearances; service lines; conveyors; hazard-posted areas

3.2. Operating data

- Functions of machine; relation to others
- Type of input: gage, size, shape of stock
- Type of output: shape, size
- Type of scrap: how collected
- General product flow with respect to other machines
- Use of automation: conveyors, robots
- Services and ratings: electrical, air, water, fuel, steam, hydraulic, internal combustion engine, vibrator
- Production rate (maximum)
- Down time: jams, breakdowns; repair, maintenance, set-up; reload, idling; operator at rest room, meals
- Constraints on operation: access, both physical and visual; for worker, input stock, output product and scrap; access for repair, maintenance, set-up, reload; safety, union regulations, sanitation, special materials for food industries, rodent control; operator need for aural cues; limits on capital and operating expenses

- Special machine features: noise control features already installed; use of vibration isolators; use of air; evidence of over-lubrication

4. Noise situation data

4.1. General observations (ear)

- Noise high or low pitched
- Directional location by cupping hands behind ears
- Presence of pure tones
- Level constant, varying slowly or with much impact noise
- Feeling of vibration in floor
- Workers communicating by word or sign
- Use by workers of aural cues in detecting and evaluating machine performance, jams

4.2. Measuring equipment

- Name, make, model, S/N
- Calibration data: when; traceable to NBS
- Check list for diagnostic acoustical measurements: SLM, octave band analyzer, 1/2-in. and 1-in. microphones, tripod, extension cord for microphone, windscreens, calibrator and adaptors; accelerometer; control box for acceleration, velocity, displacement; stroboscope; vibrating reed tachometer
- Check list for optional equipment for diagnostic acoustical measurements: two channel tape recorder, connecting cords, microphone for voice channel, blank reel, AC cord, charger; range finder, measuring roller, steel tape (inches and centimeters); flashlight; pressure-sensitive labels; camera with wide-angle lens, flash; spare batteries for all equipment (alkaline only); ear muffs, safety glasses, safety shoes, hard hat, paper towels, handsoap; pliers, diagonal cutters, screwdrivers; circuit tester

4.3. Acoustical measurements

- A, C, peak and octave band readings
- Measure at ear positions of worker, worker absent, with all machines going, then with machine in question off

- Run machine at different speeds to locate resonances
- Run with portions of machine selectively disabled
- Measure rpm's with stroboscope, vibrating reed tachometer
- Measure at suspected noise sources on machine; photograph the set-ups; locate microphone precisely
- Set to octave band for which A-weighted spectrum at ear of worker maximizes. Probe around machine to locate sources
- Locate around machine an imaginary box that touches all major surfaces; record the dimensions; at 1 m away from box, obtain levels for calculating total sound power, using procedures described by Diehl, in Machinery Acoustics, reference B.6
- On slow A-scale obtain contours of equal level around machine, others off; locate paths of workers among contours. Repeat with all machines on

4.4. Vibration measurements

- A, C, peak and octave band readings
- Probe over the surface (pickup coupled so it is not rattling) for acceleration and velocity
- Calculate root mean square values over surface
- Observe if maximum A-weighted band for rms acceleration or velocity coincides with maximum A-weighted band for airborne noise
- Run machine at different speeds to locate resonant excitation of vibration
- Selectively disable parts of machine to locate exciting sources

4.5. Auxiliary data

- Data per (3.2)
- Unusual conditions: breakdowns; machine with bad bearing, gears, loose parts
- Tape recordings of noise situations that are short-lived or non-repetitive, together with calibration signal; also useful for later narrow-band analysis, judging rpm, pure tones

- Photographs of all pertinent parts of machine, from establishing shots to close-ups of name plate
- Names, position and possibly addresses of operating, supervisory and management personnel concerned
- Time of entry to plant, time spent at each machine, time left plant

5. Development of noise control

5.1. Preliminary report

- Data, raw and reduced; evaluation, interpretation
- Preliminary noise control recommendations, taking full account of constraints in (3.2) above
- Preliminary estimate of noise reduction expected
- Preliminary estimate of capitalized installed cost
- Preliminary estimate of possible change in productivity and change in piece part cost
- Recommendations on use of automation
- Conference to discuss implications of report

5.2. Development of revised recommendations

- Remeasure as needed
- Re-estimate noise reduction, costs
- Prepare recommended experimental program if problem sufficiently unusual
- Prepare sketches showing acoustically essential features of the noise control devices; if required, prepare drawings
- Recommend special materials; provide alternate suppliers
- Estimate construction, installation costs

5.3. Installation, use

- Monitor construction and installation for adherence to acoustical specifications
- Introduce corrective measures for improperly installed devices
- Evaluate emergency alternate materials
- Measure installed performance; correct deficiencies

- Measure daily noise dose to applicable workers

6. New work

- Recommend improvements if similar noise control is to be applied to other machines of the same class
- Recommend action on problems remaining
- Provide briefings on results to technical and management people
- Prepare paper for publication
- Help prepare formal compliance reports

CASE HISTORY #1 - STEEL WIRE FABRIC MACHINE

Description of the Problem

This 8-foot fabric machine manufactures wire netting spaced at 6-inch spacings, starting with individual wires from large spools that run through the length of the machine. A perpendicular wire, known as staywire, is fed across at 6-inch intervals and spot welded at each intersection. This staywire is then cut off at the left-hand side of the machine. The long wires are then moved through the machine another 6 inches, and the staywire operation is repeated. This machine produces 6 x 6 inch #8 or #10 wire netting, which is used as concrete reinforcement in the home building industry. Machine is made by Keystone Steel and Wire Company.

Measurement and Analysis

At the operator position, the noise level was found to be 99 dBA and 102 dBC, indicating low frequency components. This kind of noise ($L_C - L_A = 3$) is very unpleasant.

Daily noise dose was found to be 2.5, where the acceptable level is 1.0.

Criteria were established to reduce the noise exposure to 1.0 or less, which is equivalent level to 90 dBA or less.

The octave band measurements made at the main drive gear (Figure 5.1.1), at the operator station (Figure 5.1.2), at the wire spool area (Figure 5.1.3) showed that noise sources included (1) general mechanical noises due to needed maintenance, (2) the wire wrapper, a ratchet-action machine operated from main drive gears and found to cause 1000-Hz peak noise, and (3) mechanical sources within the machines, which could lend themselves to isolation.

Control Approaches Considered

In addition to the direct noise corrections implied above, another solution could have been to construct a noise shelter for the operator. This solution was dropped in favor of working on specific noise sources. A program was established to:

- (1) Overhaul the machine: replace bearings, reduce metal-to-metal banging, replace worn gears, and so on.
- (2) Replace ratchet type drive on wire wrapper with chain drive. (This device pulled the long wires through the fabric machine.)

- (3) Add steel plates (10 lb/ft²) to the frame of the machine. These plates were welded to the frame to block direct air path noise to the operator from gears. The machine frame casting had many openings, which were covered by these steel plates, as shown in Figure 5.1.4.

Noise Reduction Achieved

Noise at the operator station was reduced from 99 dBA to 93 dBA (93 dBC). With this reduction, an additional source was noted and determined to be the staywire lifter arms. These were covered with a 3/8-inch-thick piece of Lexan (see Figure 5.1.5) for the full length of the operator position, hinged so that it could be easily removed for maintenance.

Operator station levels were reduced to 89 dBA and were therefore in compliance with current standards.

A shelter could have solved the problem, but where possible, attack on direct noise is recommended. When major noise sources are reduced, the contribution of other noise sources can be better determined and corrected. By redesigning the wrapper device from a ratchet to a chain drive, the production rate was increased by 50%.

Costs

Costs were mainly internal plant labor for machine overhaul, plus the cost of the steel barrier plates welded to the frame (estimated at less than \$100), plus the cost of the piece of Lexan at \$5.00/sq ft, or about \$50 plus installation labor, in plant.

Pitfalls

The major pitfall in this kind of approach is moving too fast. Testing each technique under actual conditions is far better than moving rapidly into failure. This solution required approximately 2-years-lapsed time from beginning to end.

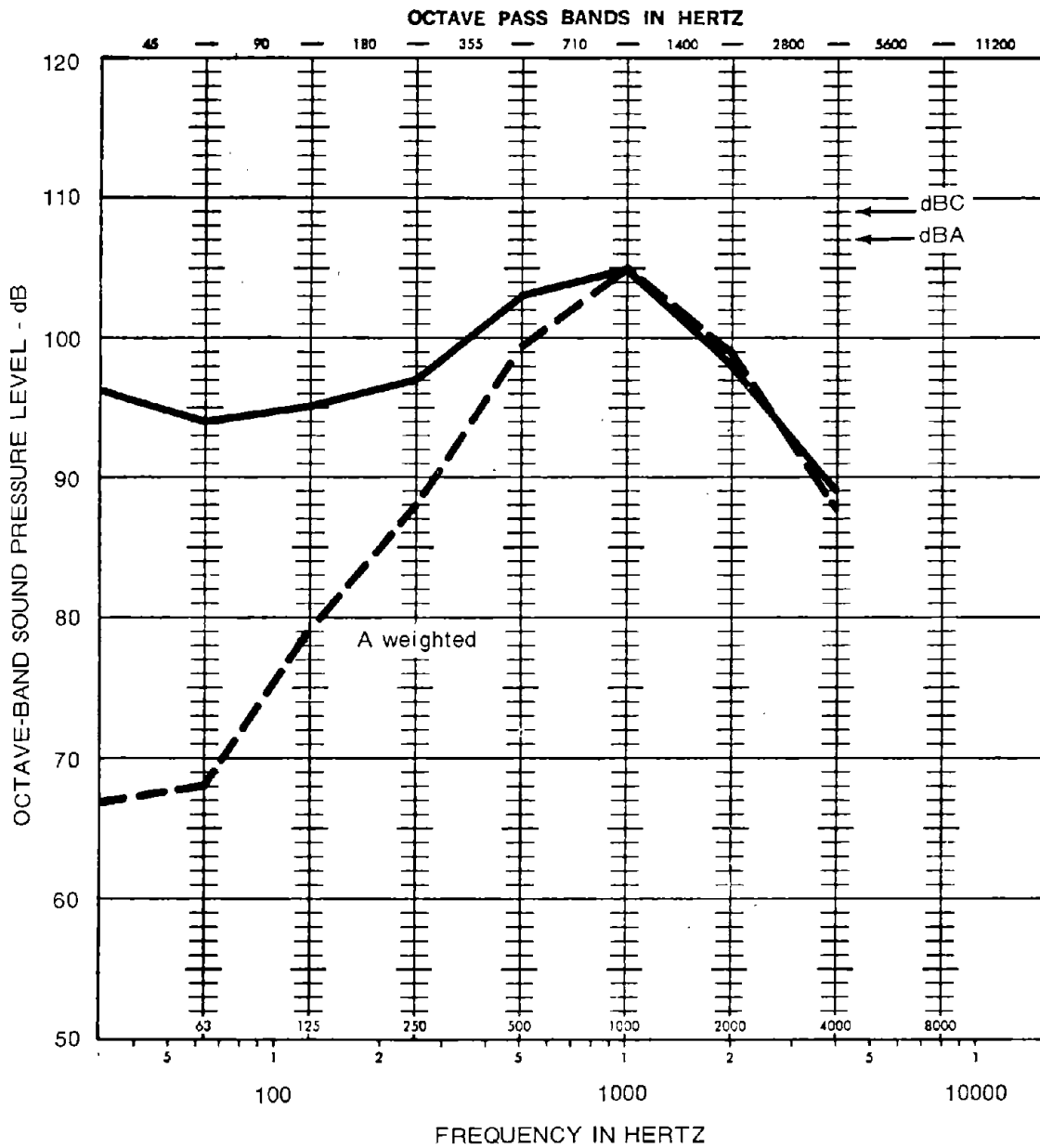

FIGURE 5.1.1 - Noise levels for 8-foot fabric machine, 1 meter from main drive gear

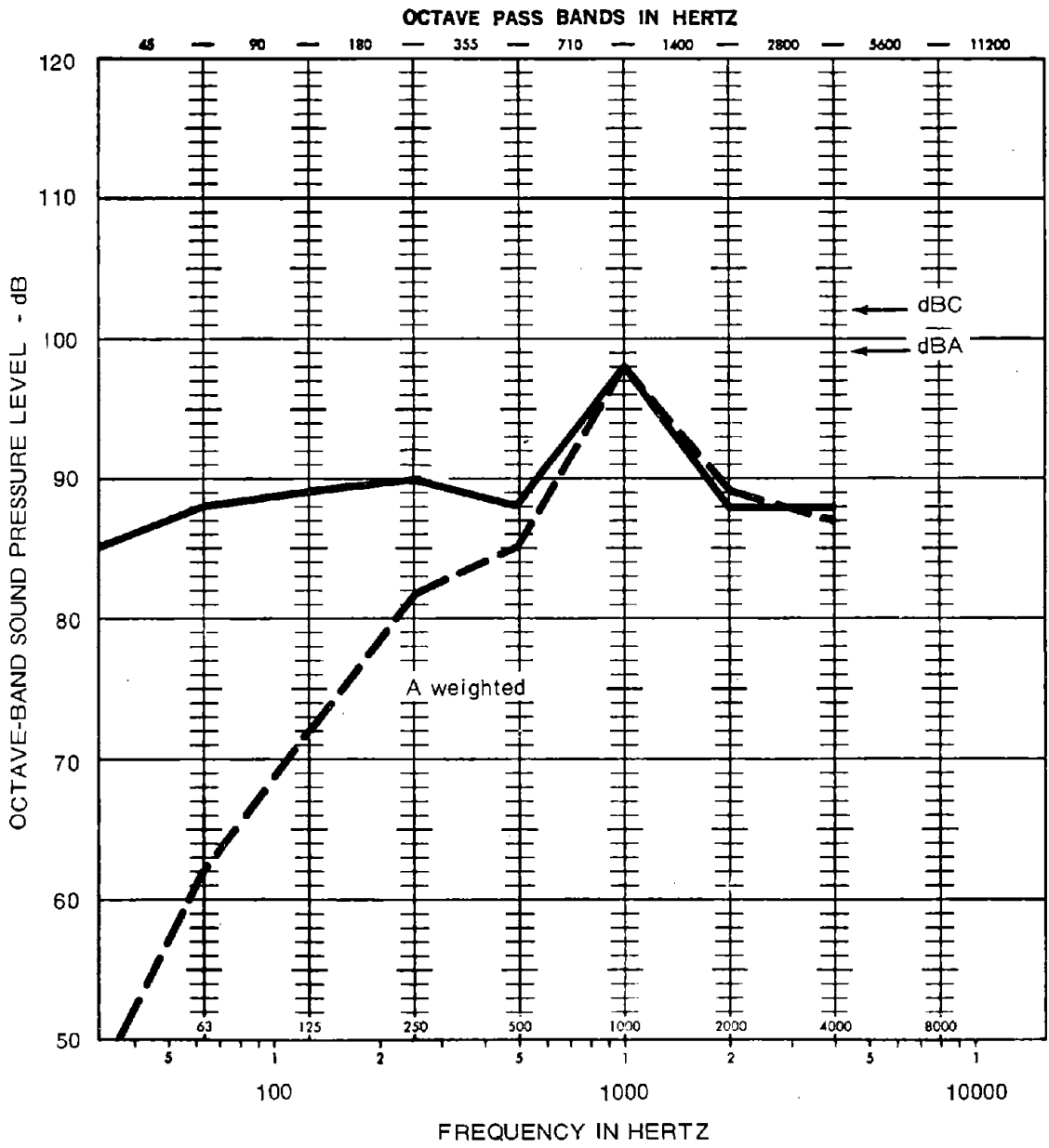

FIGURE 5.1.2 - Noise levels for 8-foot fabric machine operator station

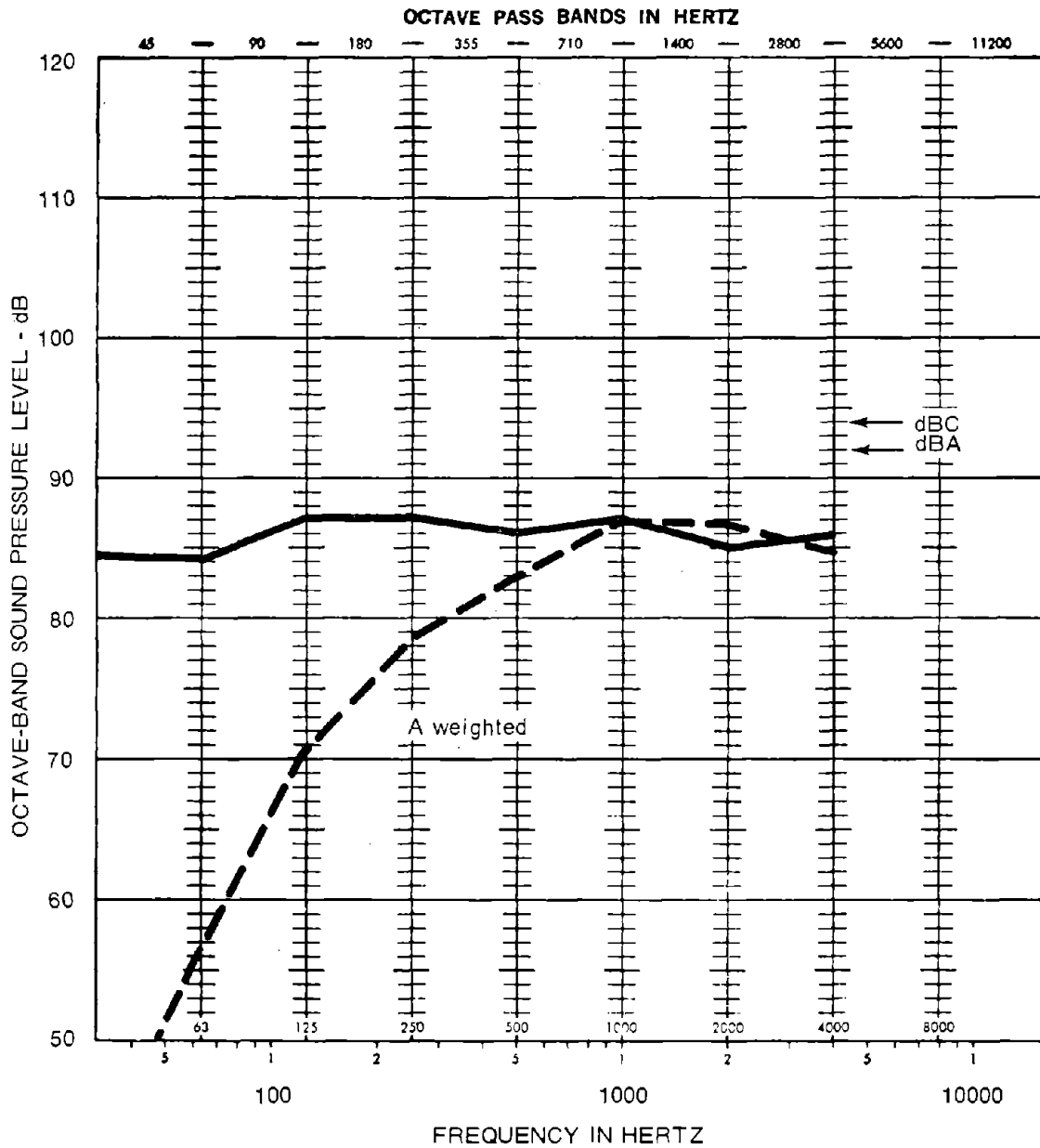

FIGURE 5.1.3 - Noise levels for 8-foot fabric machine, 1 meter behind operator station in wire spool area

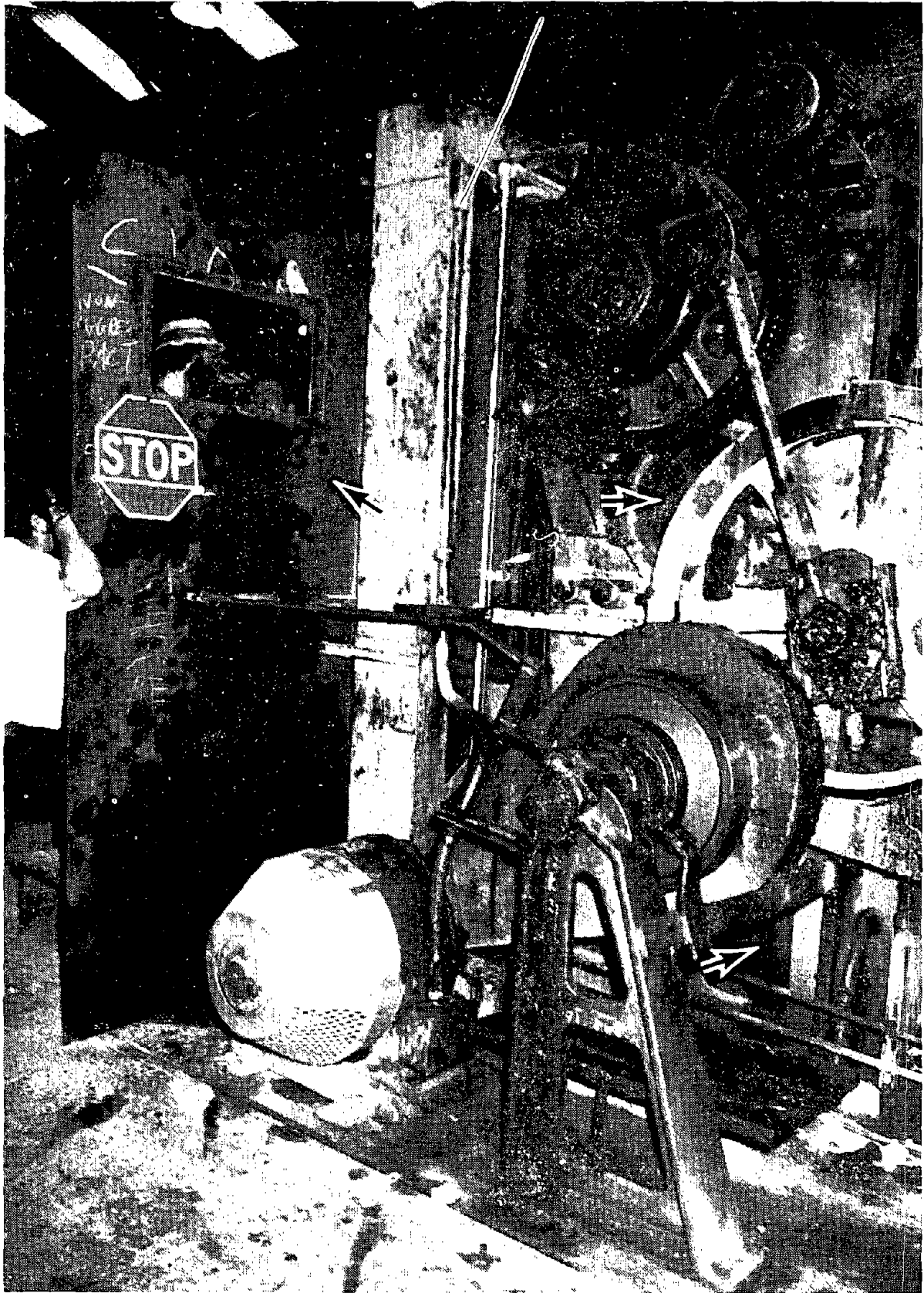

FIGURE 5.1.4 - Steel plate barrier with window (stop sign hung on it).

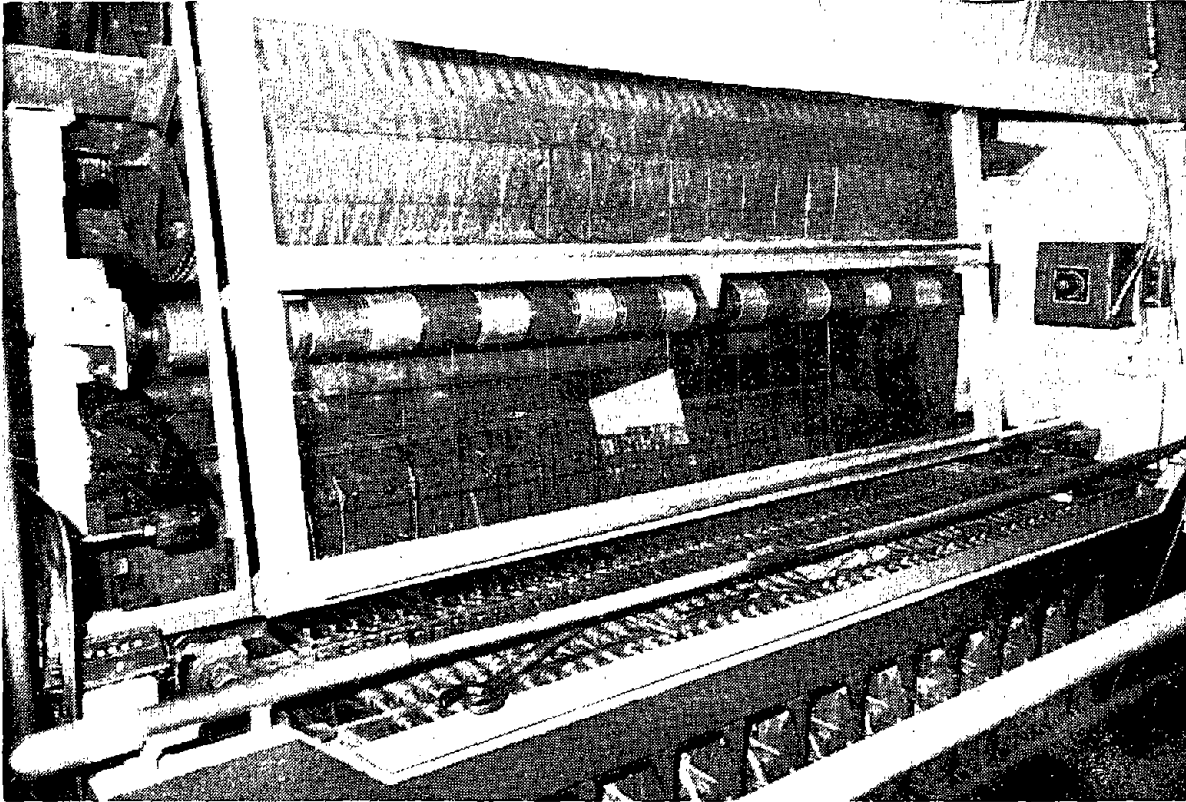

FIGURE 5.1.5 - Lexan barrier in two sections; slides up for access.

CASE HISTORY #2 - 800-TON VERNON BLANKING PRESS -
VIBRATION ISOLATION

Description of the Problem

The 800-ton Verson press is a massive unit weighing about 275,000 pounds, mounted on four footings set on heavy concrete piers. Production on this press was automobile chassis steel sections of 1/4-inch steel about 10 inches wide and 8 to 10 feet long. Normal operating speed was 30/min. Steel stock was fed to the press from a reel. Noise levels were about 120 dB impact, 105 dB quasi-peak, and 94.5 dBA at operator location, which was about four feet in front of the press.

Control Approach Chosen

As a starting point to the total solution of the noise problem, it was decided to vibration isolate the press and determine the attenuation gained before working on other noise sources, which are not part of this case history.

Measurement and Analysis

The press was operated in a single shot mode. Hence quasi-peak readings for each octave band were more meaningful for ear effect than rms readings (slow A-scale). The peak value is the maximum level reached by the noise, whereas quasi-peak is a continuously indicating measure of the average (over 600 msec) of the high levels reached just before the time of indication and is thus lower than the actual peak but is greater than slow A-scale values.

Vibration data were recorded for the support foundation, floor near press, adjacent building column, and press structure at the press feet, before and after installation of the isolators.

Isolators

From the data supplied on strokes per minute and press weight, the isolators were specified to be Vibration Dynamics Corporation (of Lagrange, Illinois) series BFM micro/level isolators, under the press feet. No price lists are available because each isolation problem is specifically engineered and quoted. Cost was about \$2,000 for the isolators, and installation by in-plant labor was probably about \$1,000.

Noise Reduction and Vibration Reduction Achieved

Adding isolating pads reduced the vertical acceleration at the pier by 9.5 dB, as shown in Figure 5.2.1. Most of the reduction

occurred in the 2, 4, and 8 kHz bands. The vertical foot-to-pier acceleration reduction was 30 dB.

In Figure 5.2.2 is shown the horizontal acceleration at the pier. Adding isolation effected a 12 dB reduction in acceleration. The horizontal foot-to-pier acceleration was reduced 36 dB by the isolating pads.

The attenuation afforded by the pads is shown in Figure 5.2.3, for both vertical and horizontal motion of the pier. Note that it is the vertical motion that is responsible for most of the sound radiated by the floor.

Figures 5.2.4 and 5.2.5 are comparisons of the sound level readings at 4 ft before and after isolation (quasi-peak readings, single shot operation). The calculated dBA level in Figure 5.2.5 shows a reduction of 6.5 dBA in airborne noise.

Isolators reduced vibration in support foundation, floor, building, column, and press structure. It has been found that a primary cause of background, or ambient, noise is the vibration in the building structure, which is presumed to be caused by the anchor bolt after-shock.

Calculation here shows that there was a 105-dBA quasi-peak sound level before isolation and a 98.5-dBA level after isolation. With a relationship of about 10 dB quasi-peak to rms, a reduction in level from 94.5 dBA to 88 dBA at operator location has been made. Additional presses will add their own noise and will increase levels to above 90 dBA. Other operational noise sources in the press must be controlled separately.

Pitfalls and Rewards

The major pitfall of this approach is that airborne sound level reduction due to vibration isolation is almost impossible to predict. However, a serious noise control program in such operations must include isolation devices for all presses.

A reward is that the die life and maintenance of such machines is significantly increased for presses that are vibration isolated. Isolators improve operation and maintenance by reducing failures of anchor bolts, foundation failure, or breaking of press feet.

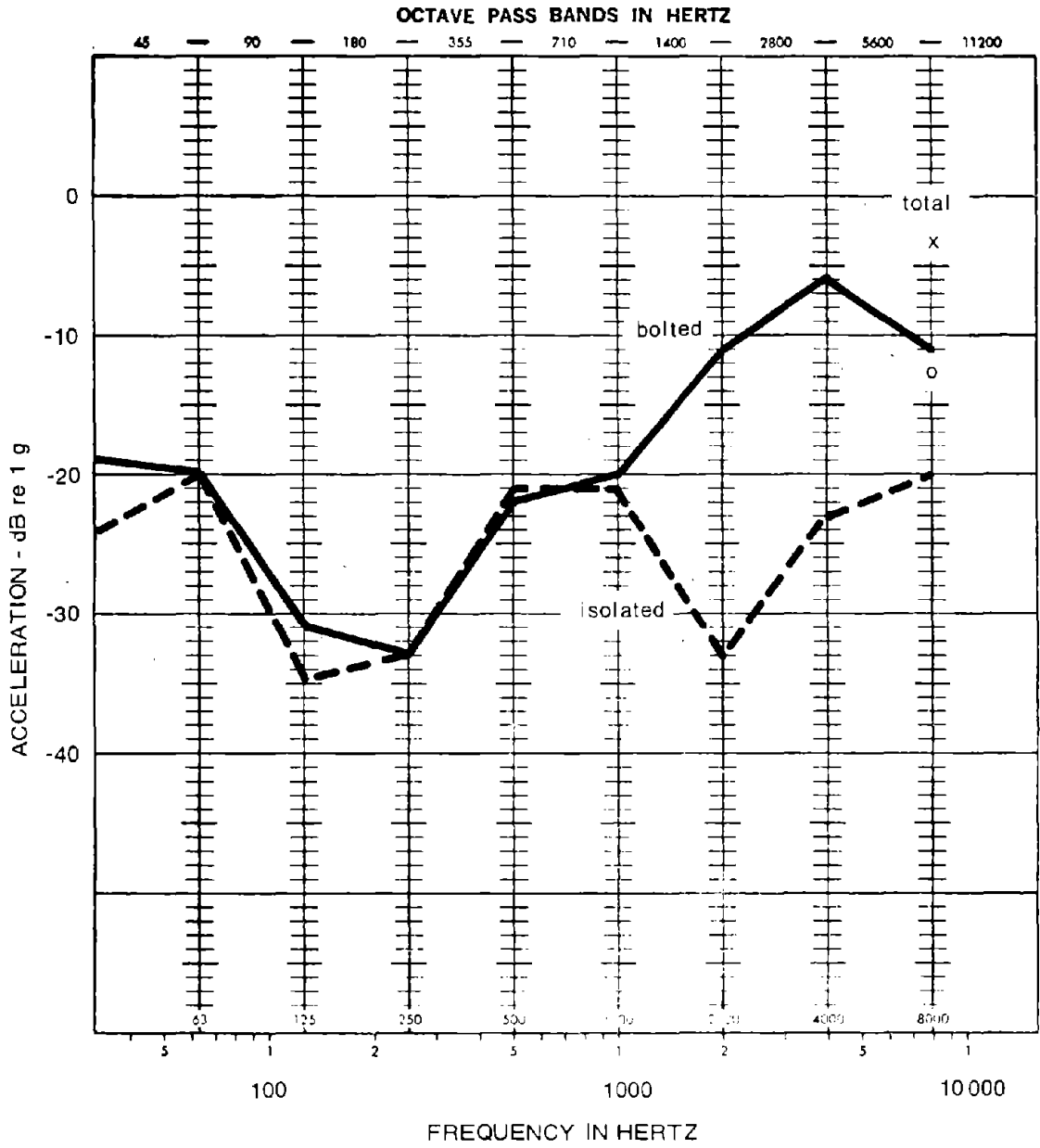

FIGURE 5.2.1 - Vertical acceleration on pier, before and after isolation

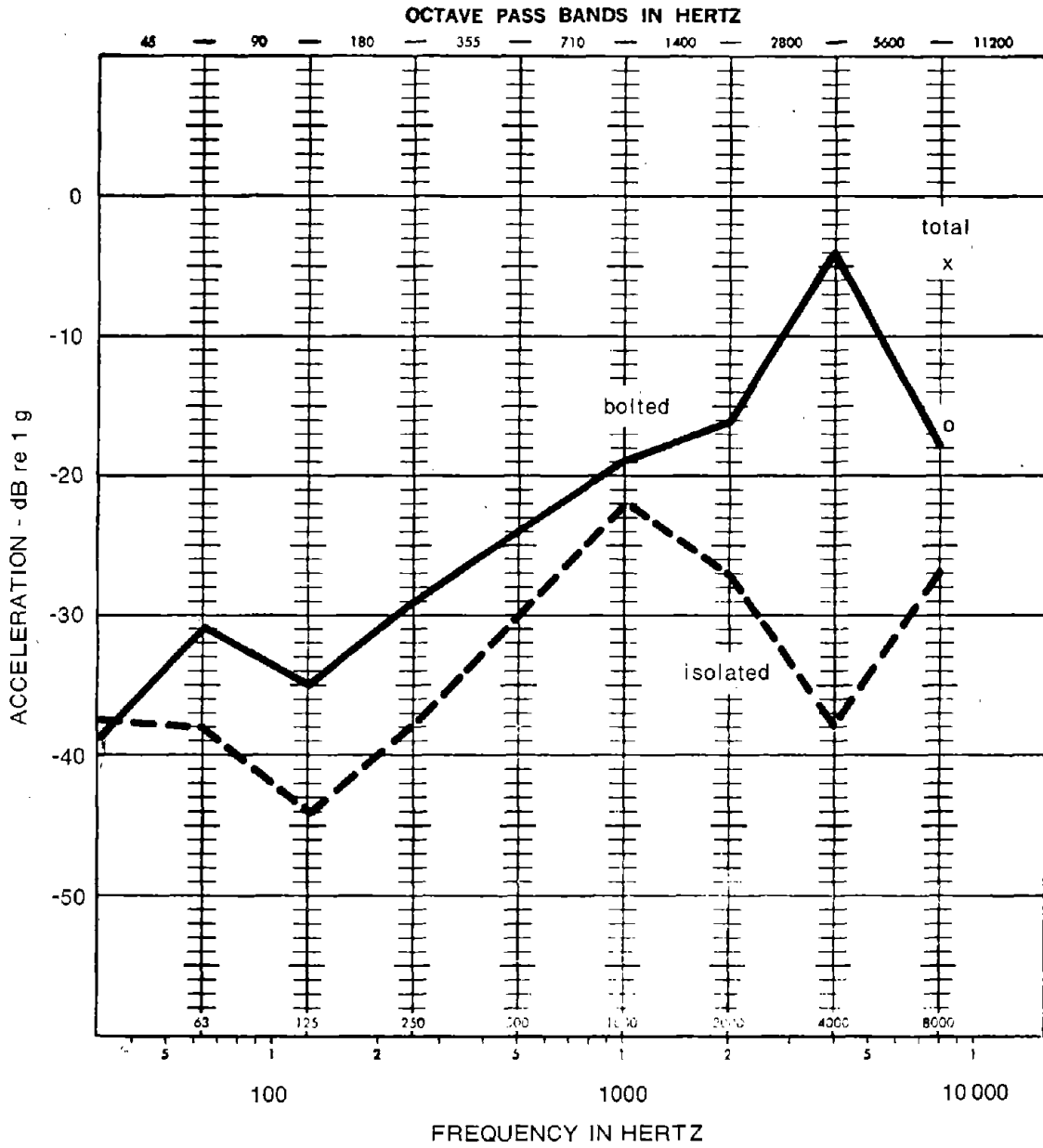

FIGURE 5.2.2 - Horizontal acceleration on pier, before and after isolation

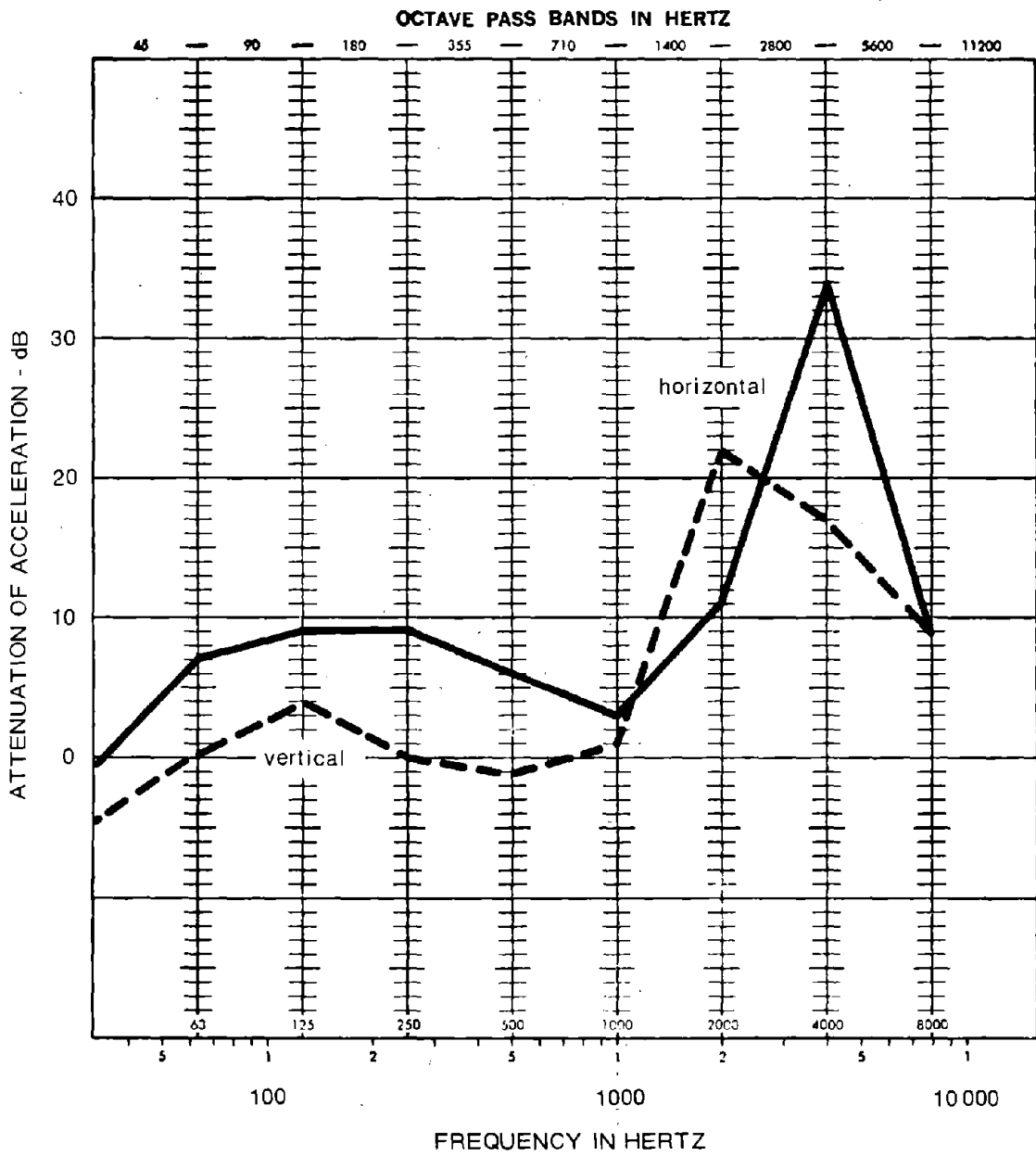

FIGURE 5.2.3 - Attenuation of vertical and horizontal accelerations at pier by adding isolation

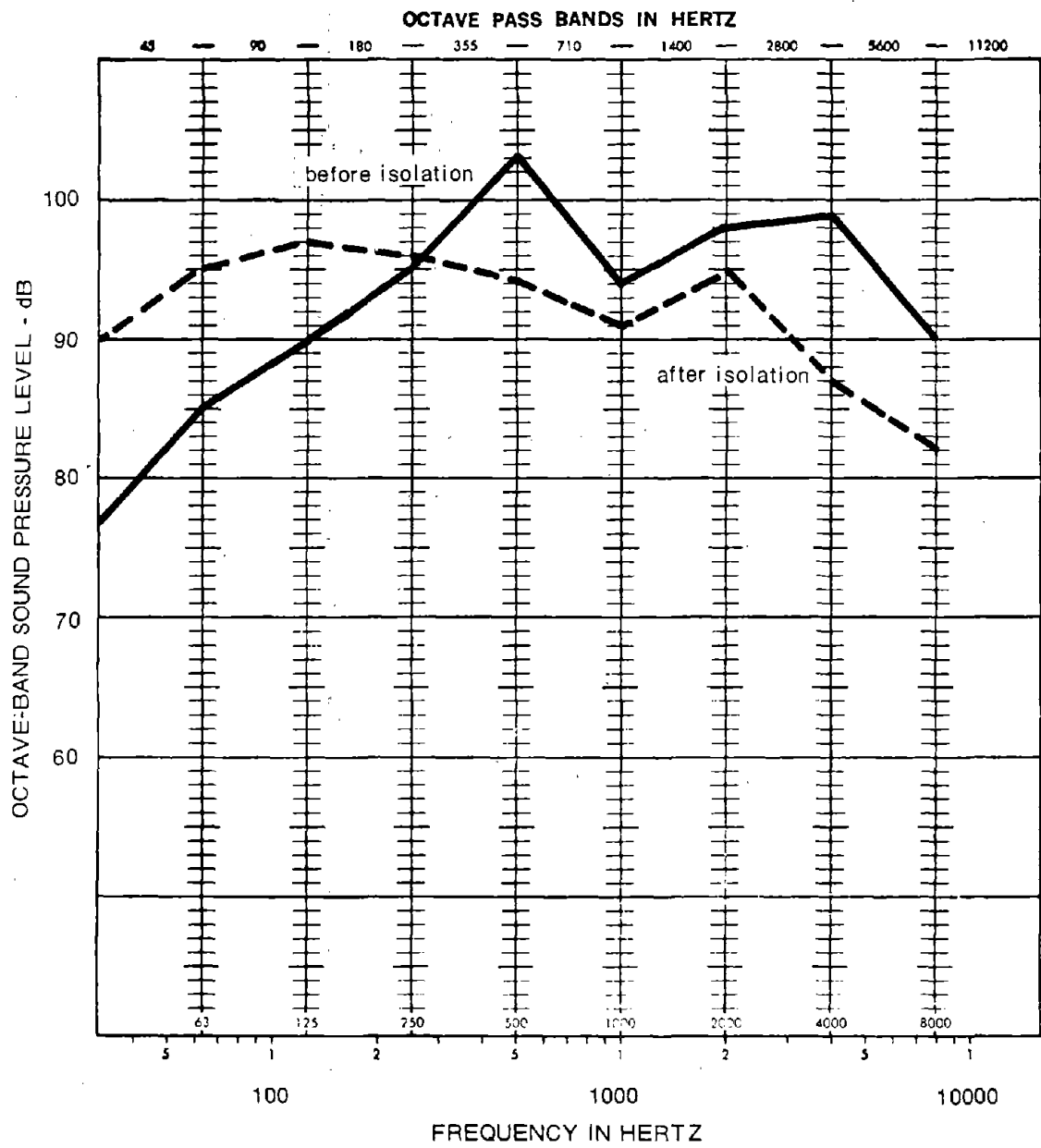

FIGURE 5.2.4 - Quasi-peak levels 4 feet from press foot before and after isolation

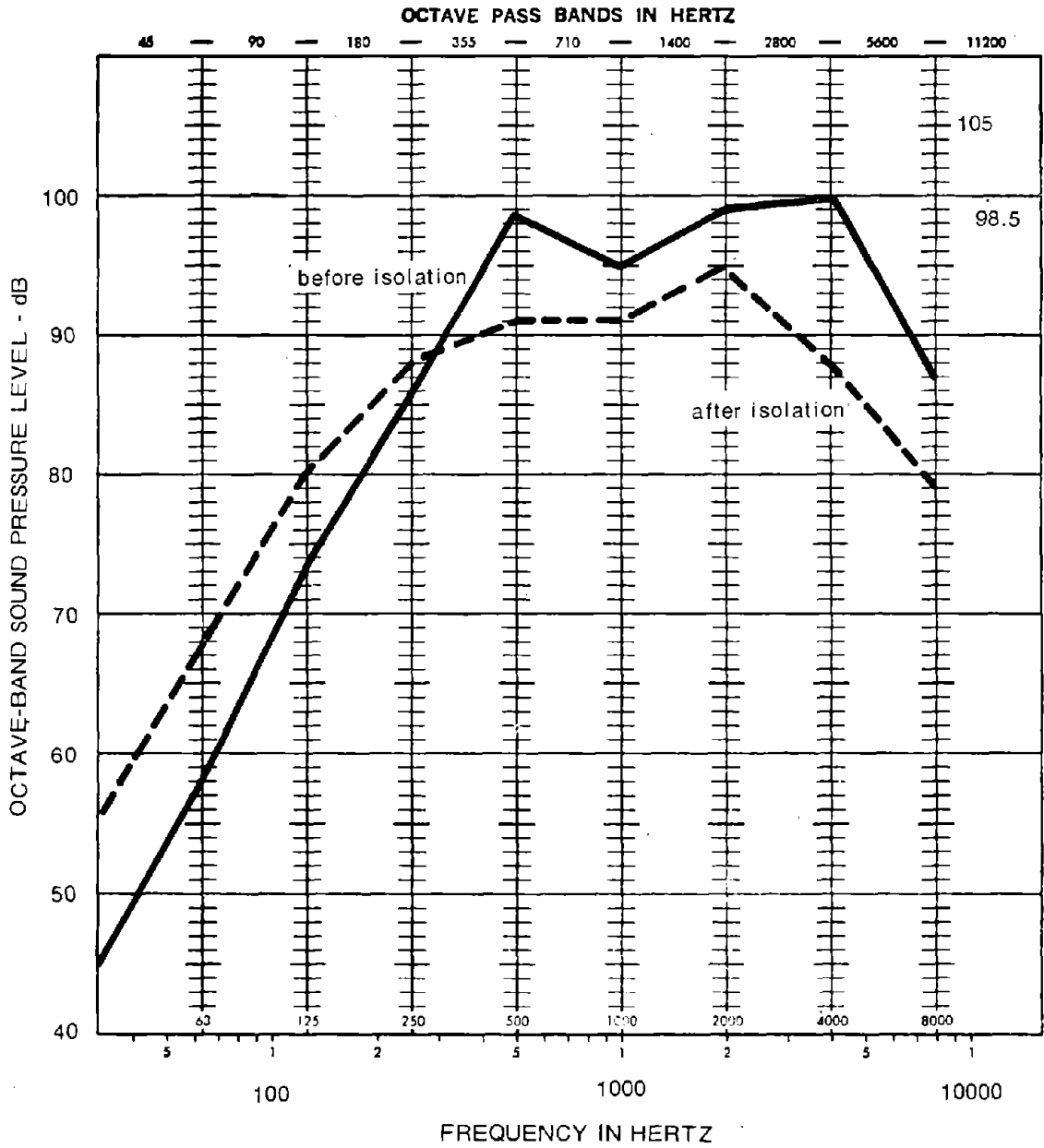

FIGURE 5.2.5 - A-weighted quasi-peak levels 4 feet from press foot before and after isolation

CASE HISTORY #3 - BLOOD PLASMA CENTRIFUGE

Description of the Problem

This plasma production room has two parallel banks of centrifuges, 15 to a bank, plus refrigeration units. A sketch of one centrifuge is shown in Figure 5.3.1. Centrifuge spinning frequency is 13,000 rpm (217 Hz). Though centrifuges appeared to be the major noise source, refrigeration units were also considered. The same refrigeration units without centrifuges are used in a separate re-constituting room.

Measurements and Analysis

Operator level was 97 dBA with one bank in operation; 100 dBA was predicted with both banks operating. Octave band readings of operator levels are shown in Figure 5.3.2.

Often close-in measurements of a complex noise source will aid in determining specific areas requiring correction. With this thought in mind, we made close-in diagnostic readings at the locations shown in Figure 5.3.3. Octave band readings for each of these locations are shown in Figures 5.3.4. through 5.3.9.

See Figure 5.3.3 for sketch of centrifuge showing locations of close diagnostic readings and octave band charts, from 31.5 to 8000 Hz. Note from these the following facts:

- (1) From Figure 5.3.2, operator position, note that the major noise contribution to the A-reading is in the 500-Hz and 1000-Hz bands.
- (2) All other locations show similar maximum bands when close readings are made of the various suspect items of this assembly, Figures 5.3.4 through 5.3.9.
- (3) Highest levels with similar bands are noted for Figure 5.3.8, close to motor exhaust, showing that the motor exhaust is the major noise source.
- (4) From these octave band readings, the spectral content of the overall noise can be gleaned. Of course, it is the A-weighted level at the operator's work station (dotted line Figure 5.3.2) that is OSHA regulated and needs to be reduced, since the A-level measurement characterizes the noise much as the human ear responds to it. Figure 5.3.2 shows that the largest contribution to the A-readings are from the 500- and 1000-Hz bands,

so our noise control diagnosis and correction efforts should concentrate on these bands.

- (5) The centrifuge spinning frequency of 217 Hz from the original data adds to the weak 250-Hz level, but as can be seen from Figure 5.3.2, is not a large contributor to existing A-levels and can be safely ignored.

Data from the reconstituting room are shown in Figures 5.3.10 through 5.3.12. This room has no centrifuge, so the noise source is predominantly the refrigeration unit, which has a maximum at 500 Hz (though only at 82 dBA), but does confirm that this is a possible noise source for the 500-Hz band in the centrifuge plus compressor room.

Control Approaches Considered

We conclude from the above data that the maximum band at 1000 Hz is a major contributor. The same maximum occurs on Figure 5.3.8 (close to the motor exhaust) and in Figure 5.3.4, where the noise is presumed to be reflected from the highly reflective metal pulley guard surfaces. These data confirm that the major noise source to be attenuated is the motor exhaust.

The results of our measurements indicated an unacceptable exposure when the operator was exposed for 4 hours to both centrifuge banks (Figure 5.3.2 predicted level at 100 dBA). Under these conditions, the operator's daily dose was 2.0, and thus exceeded the acceptable exposure of 1.0 as specified by OSHA noise regulations.

There are three general locations for controlling noise: at the source, along the transmission path, or at the receiver. Two could be used in this case. A properly designed and constructed muffler or partial enclosure for the centrifuge motor exhaust would provide the necessary source control, using materials and geometric configuration that have effective attenuation in the 1000 to 4000 Hz bands. Such a control measure would provide an expected 3 to 7 dBA attenuation.

Noise control measures can also be used along the path of transmission. The paths of airborne noise transmission were from direct and reverberant fields such as walls, floor, and ceiling, which supply very little noise absorption.

For direct field reduction, barriers with the proper transmission loss, dimensions, and orientation may be used. The reverberant field can be controlled by the addition of absorbent materials. These combined measures would reduce operator exposure 5 to 15 dBA.

Control Approach Chosen

Although the above solution would satisfy the noise control requirements, other solution possibilities should be discussed with company representatives as they are able to specify important operating, maintenance, and production constraints that may limit the type of noise control means.

In this case, after discussion, two of the possible control methods were eliminated. The hard and impervious walls had to remain because of the need for daily sterilization by high pressure steam and water hosing, and hand scrubbing. A porous absorbent surface would provide areas for bacterial growth and would not withstand the rigorous daily cleaning. A barrier to shield the operator from the centrifuge motor noise was eliminated from consideration because it would block the proper flow of refrigerated air. A small warming of the plasma would produce an unusable product. It was decided to try the motor exhaust muffler and see how much noise reduction could be achieved.

The muffler was designed with a stainless steel outer skin, lined with acoustical absorbent spaced 2 inches from the inside of the steel shell, using small blocks. The 2-inch air space allows absorption since it reflects from the inner steel surface and back through the absorbent. The muffler has one 90-degree bend, as shown in the sketch in Figure 5.3.13. In-house shop cost was estimated at \$300.

Noise Reduction Achieved

Noise at the operator's position was reduced from 97 dBA to 92 dBA, satisfactory for a four-hour employee. The motors of both centrifuges must be treated if they operate together.

Pitfalls

An airtight seal at the junction of muffler and motor is very important; we used resilient caulking compound as sealants. An air leak of area no more than ten percent of the muffler cross section would pass as much noise as if the muffler were not there at all. An intake muffler would probably also help, but noise from other sources would then become prominent.

Effectiveness of noise control is reduced if path of vibration transmission is not held to minimum. Accordingly, it was very important to use as few absorbent spacers as possible. In so doing, the steel skin vibration was kept small. The spacers can be made of damping material to reduce resonant vibration of the skin.

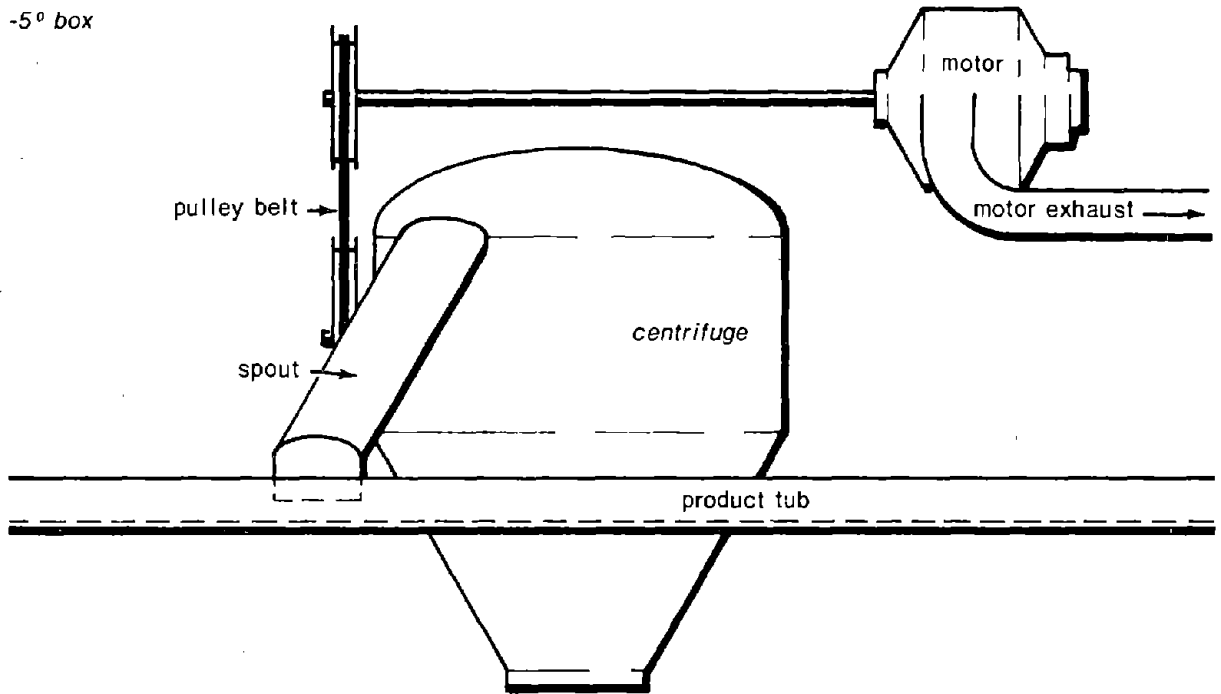

FIGURE 5.3.1 - Sketch of one centrifuge (front view)

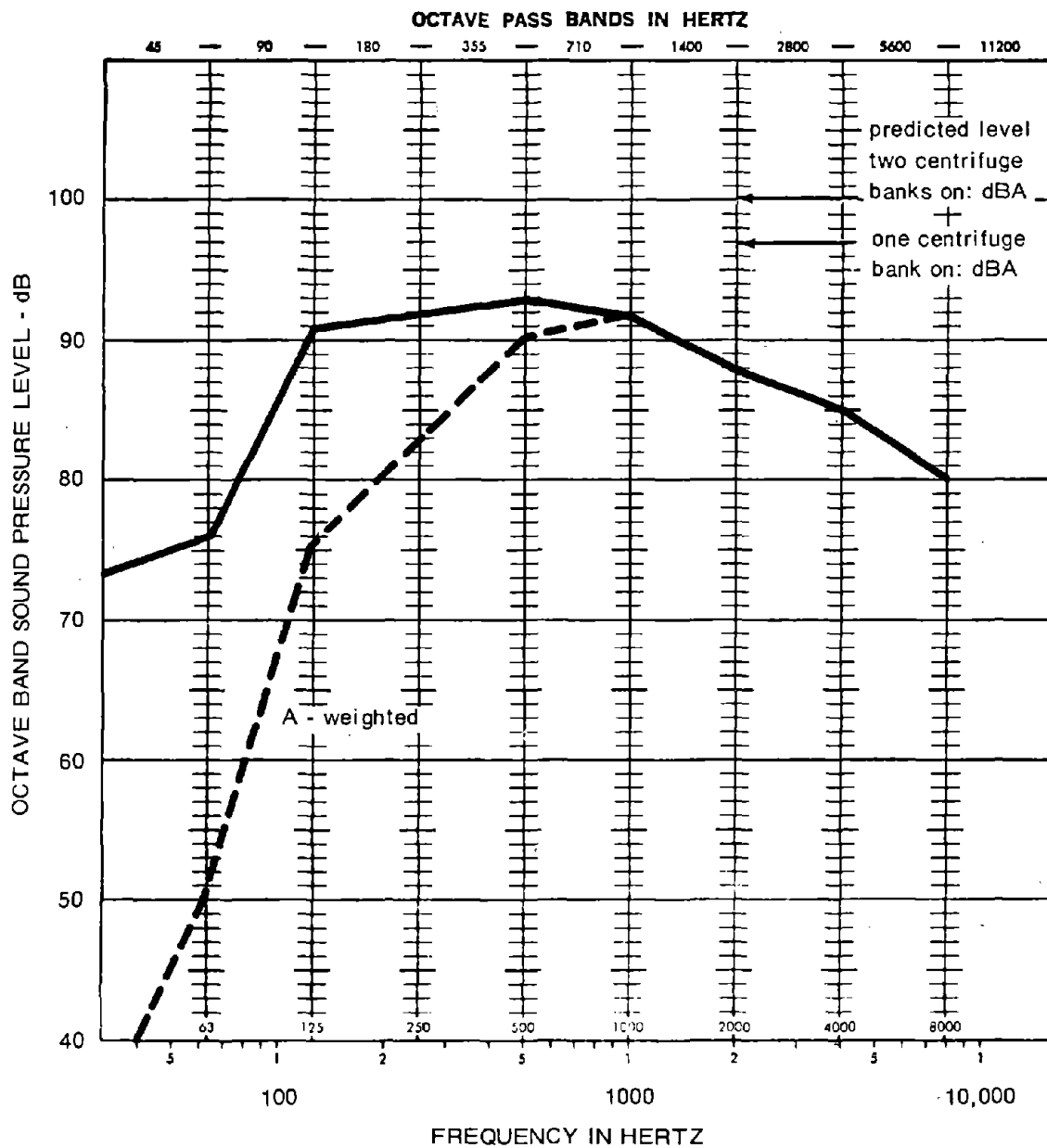

FIGURE 5.3.2 - Operator exposure in -5° C box room (below clock, 3 cm from clock wall)

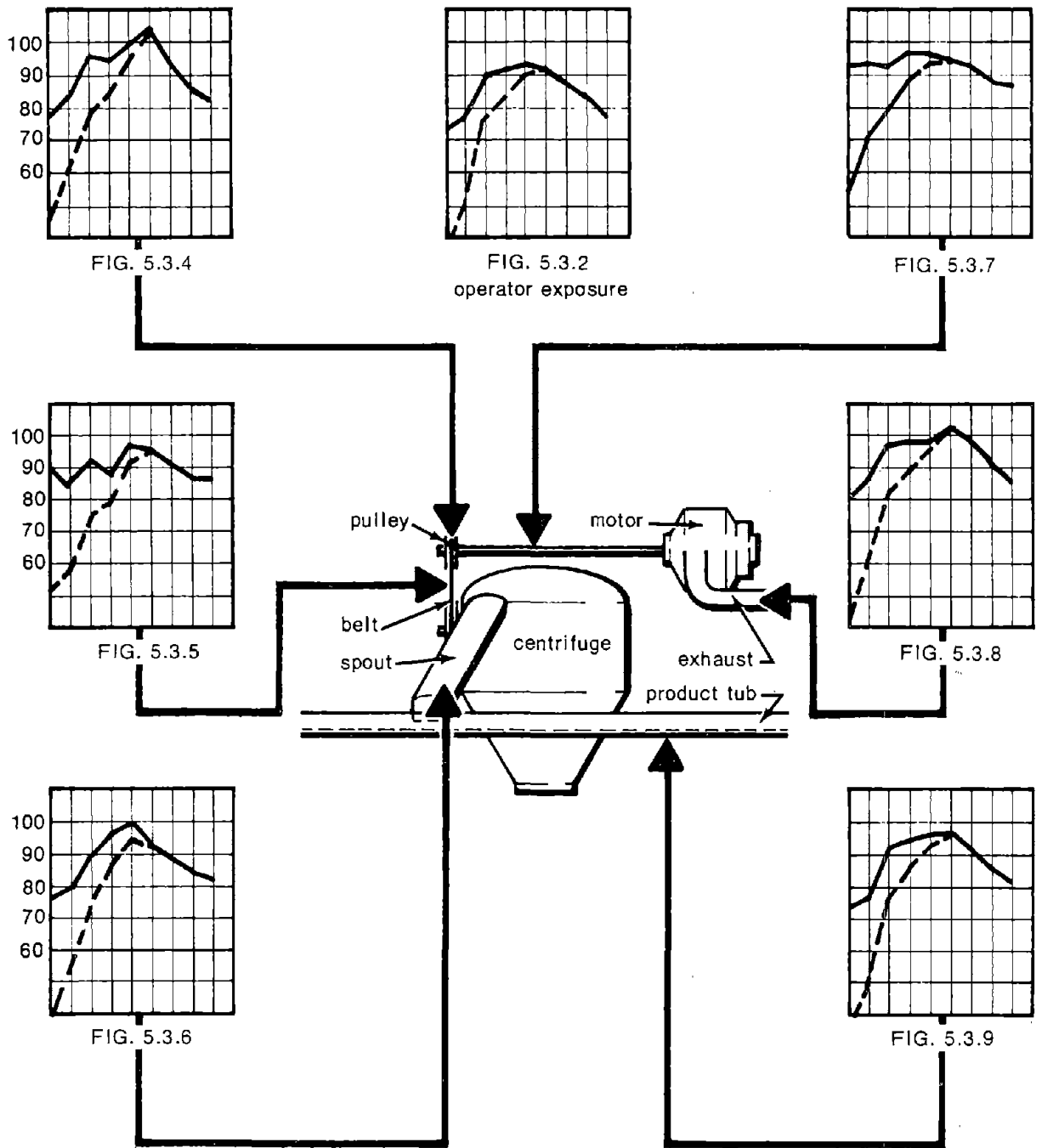

FIGURE 5.3.3 - Sketch of centrifuge showing locations for close - in diagnostic readings

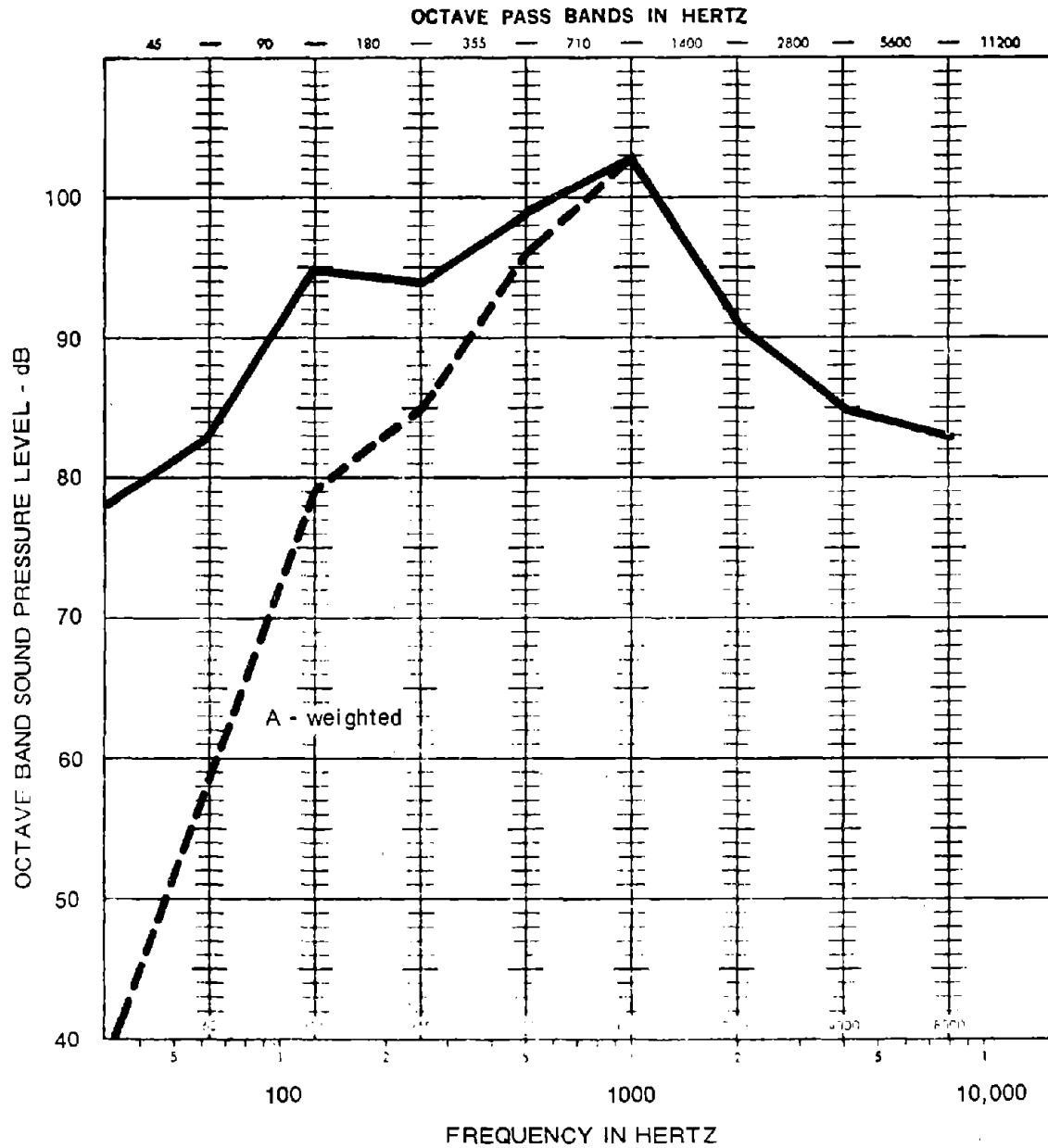

FIGURE 5.3.4 - Centrifuge noise measured parallel to motor shaft (2 cm from pulley belt guard; between #25 guard and motor exhaust of adjacent centrifuge)

Reproduced from
 best available copy.

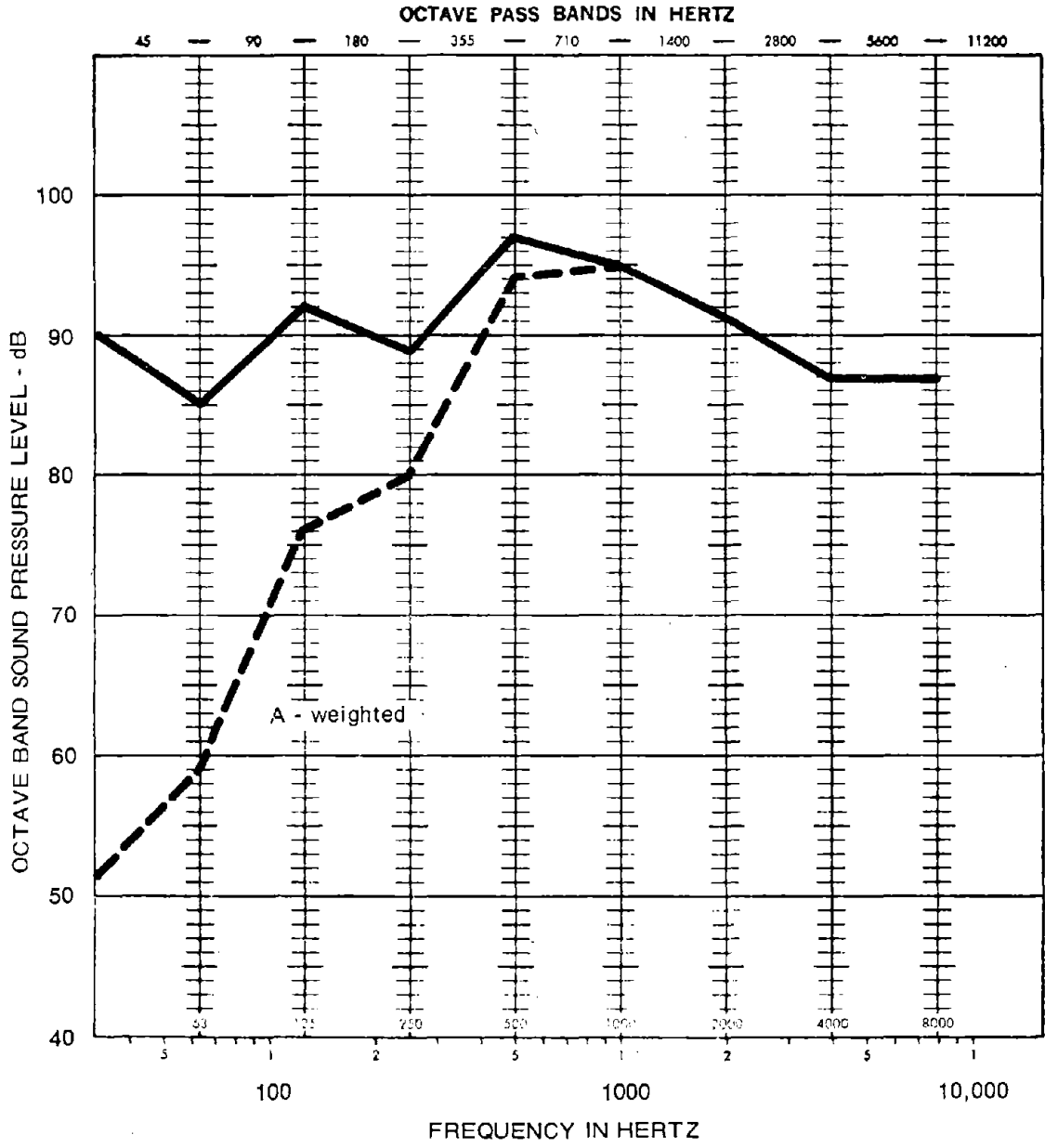

FIGURE 5.3.5 - Centrifuge noise measured 15 cm directly below pulley

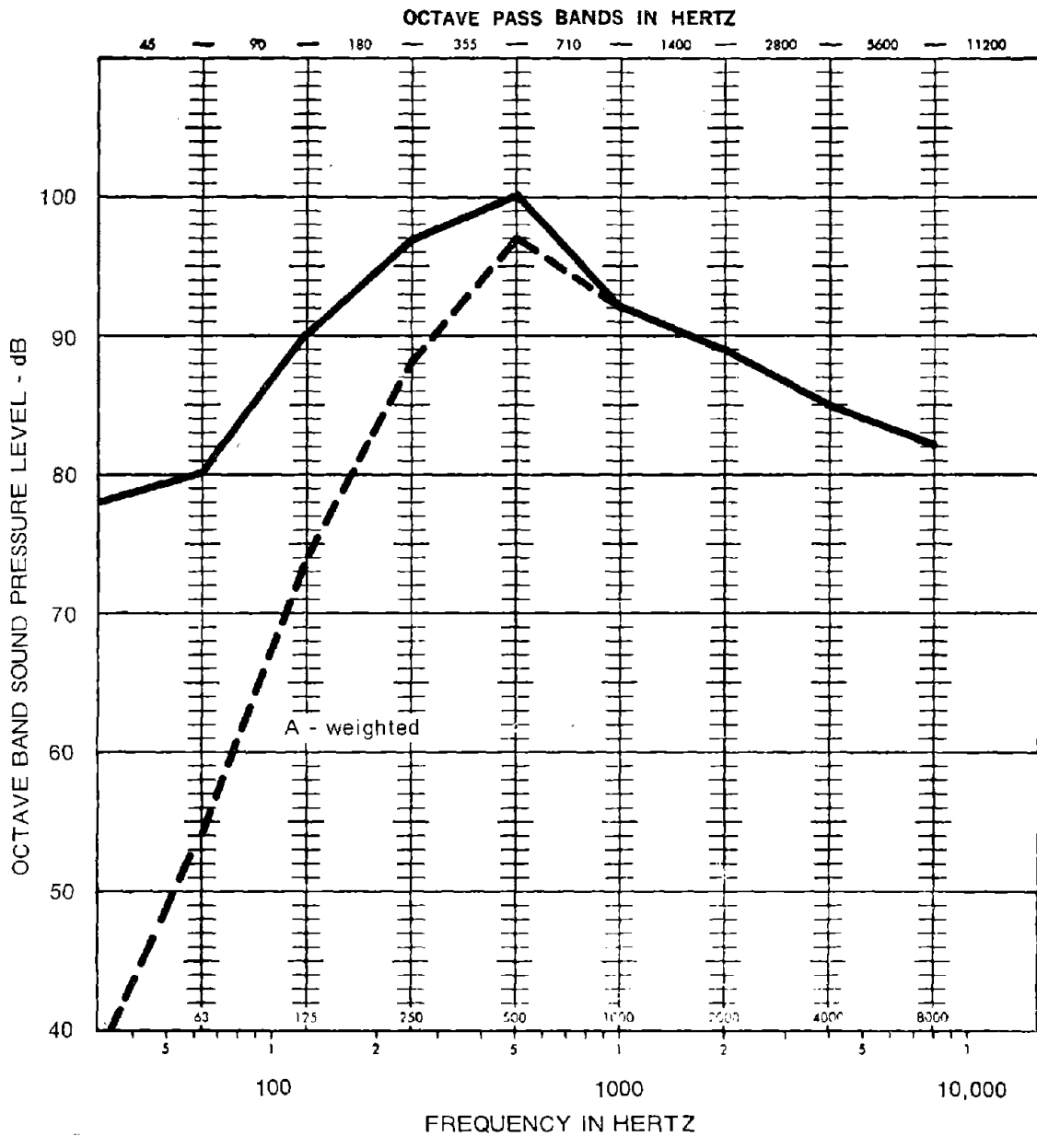

FIGURE 5.3.6 - Centrifuge noise measured perpendicular to spout (3 cm away, facing clock)

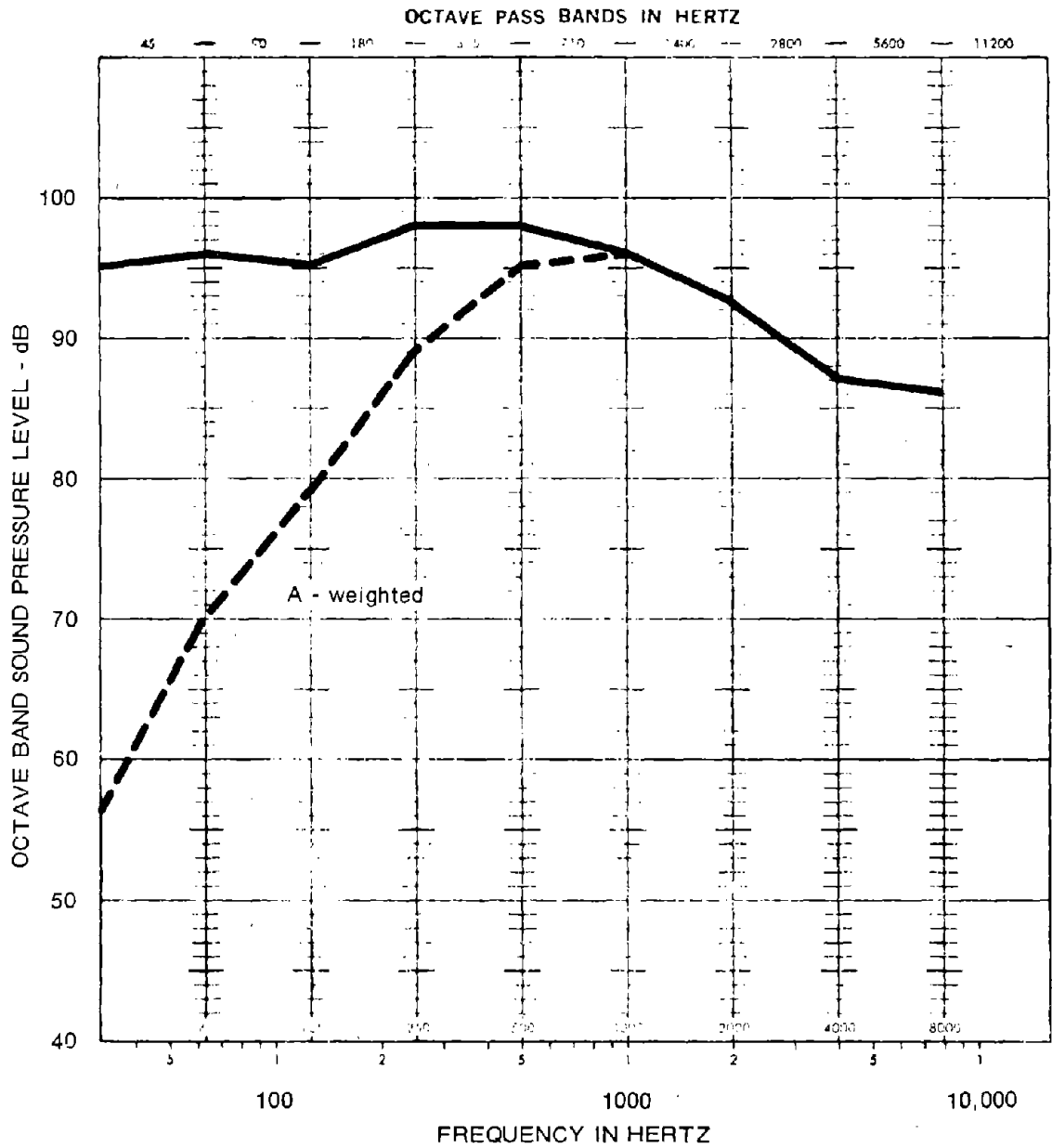

FIGURE 5.3.7 - Centrifuge noise measured between centrifuge motor and pulley belt (normal to shaft 10 cm away)

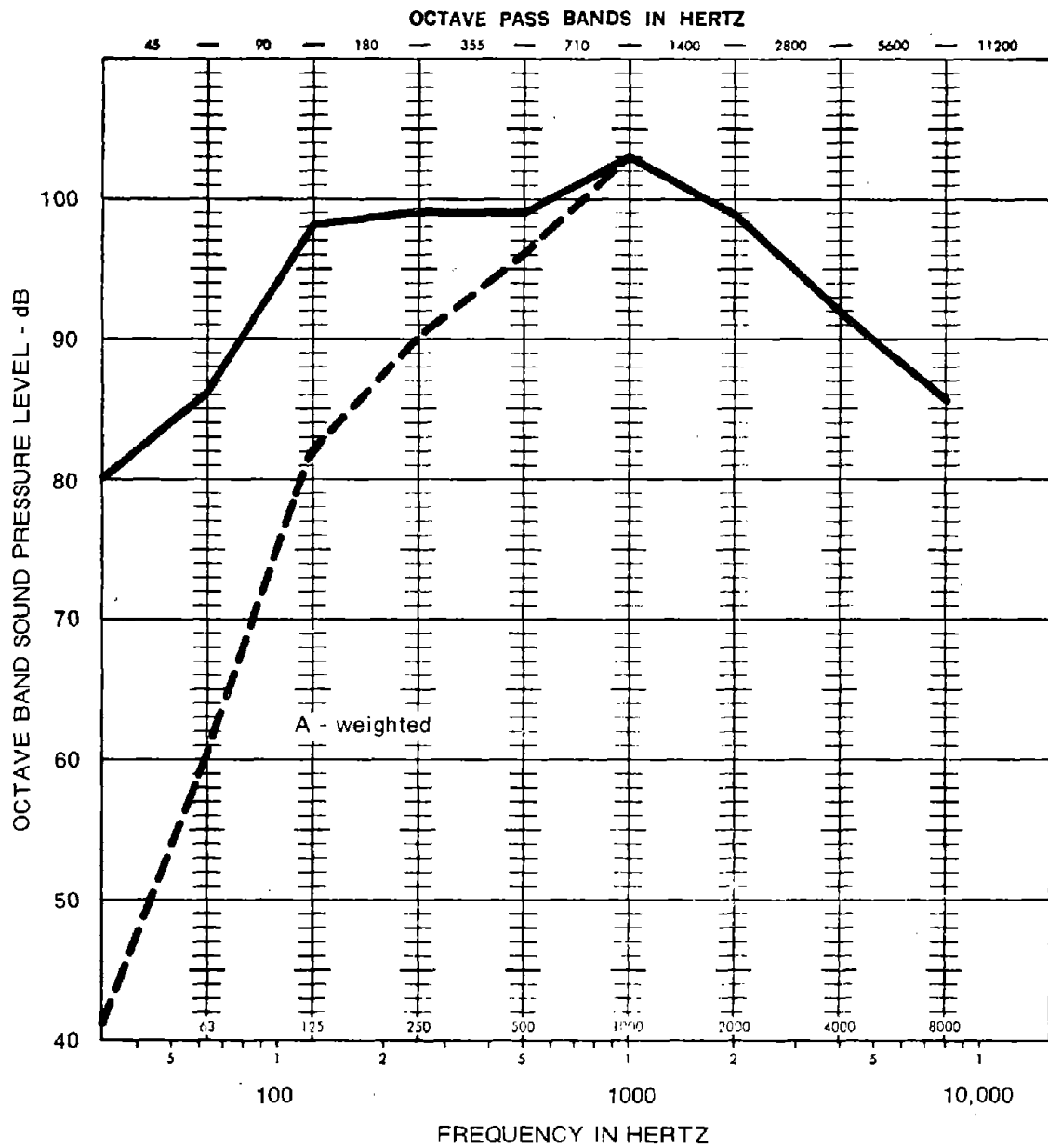

FIGURE 5.3.8 - Centrifuge noise measured 2 cm from centrifuge motor exhaust

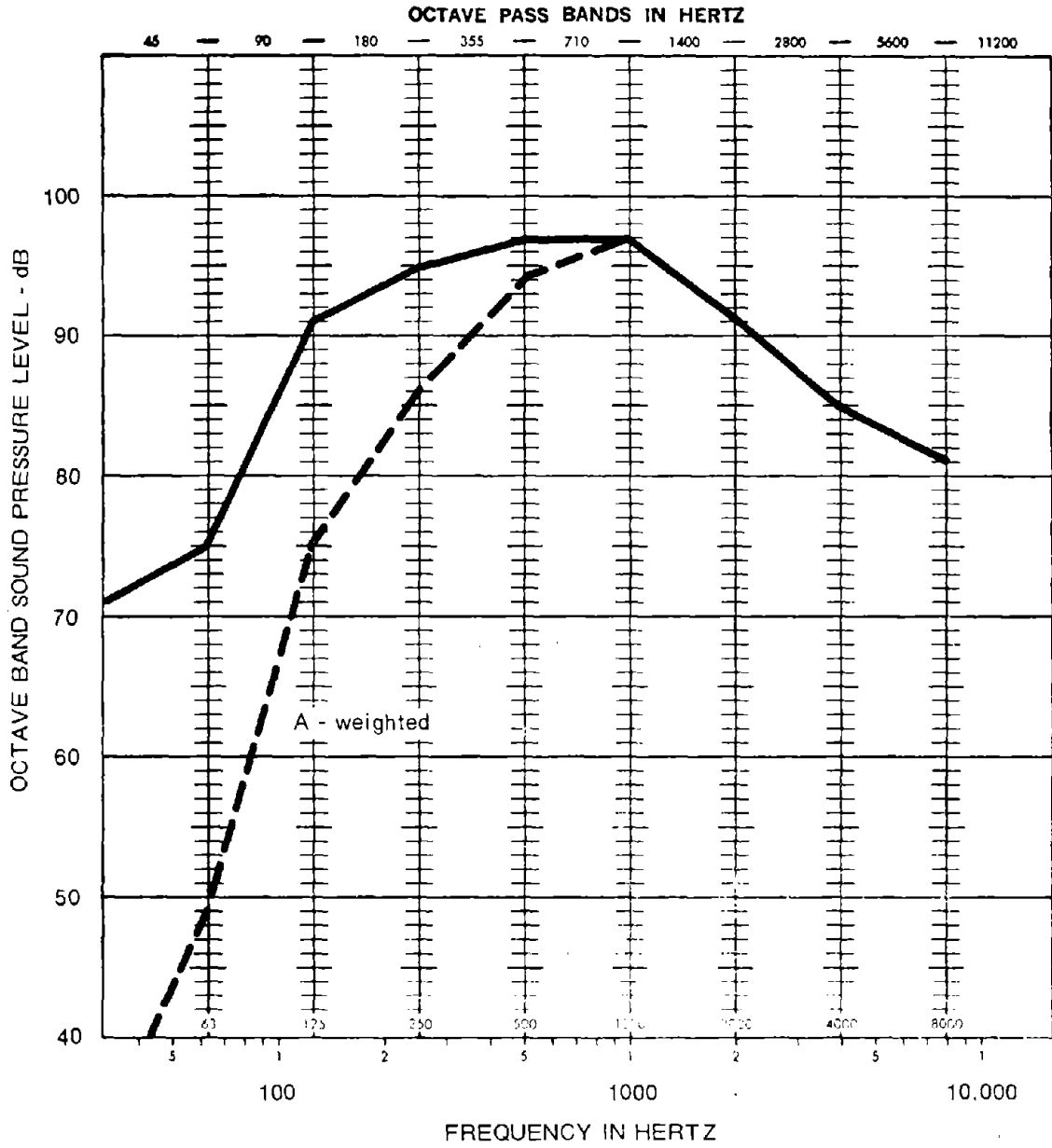

FIGURE 5.3.9 - Centrifuge noise measured at tub height (2 cm from front tub edge)

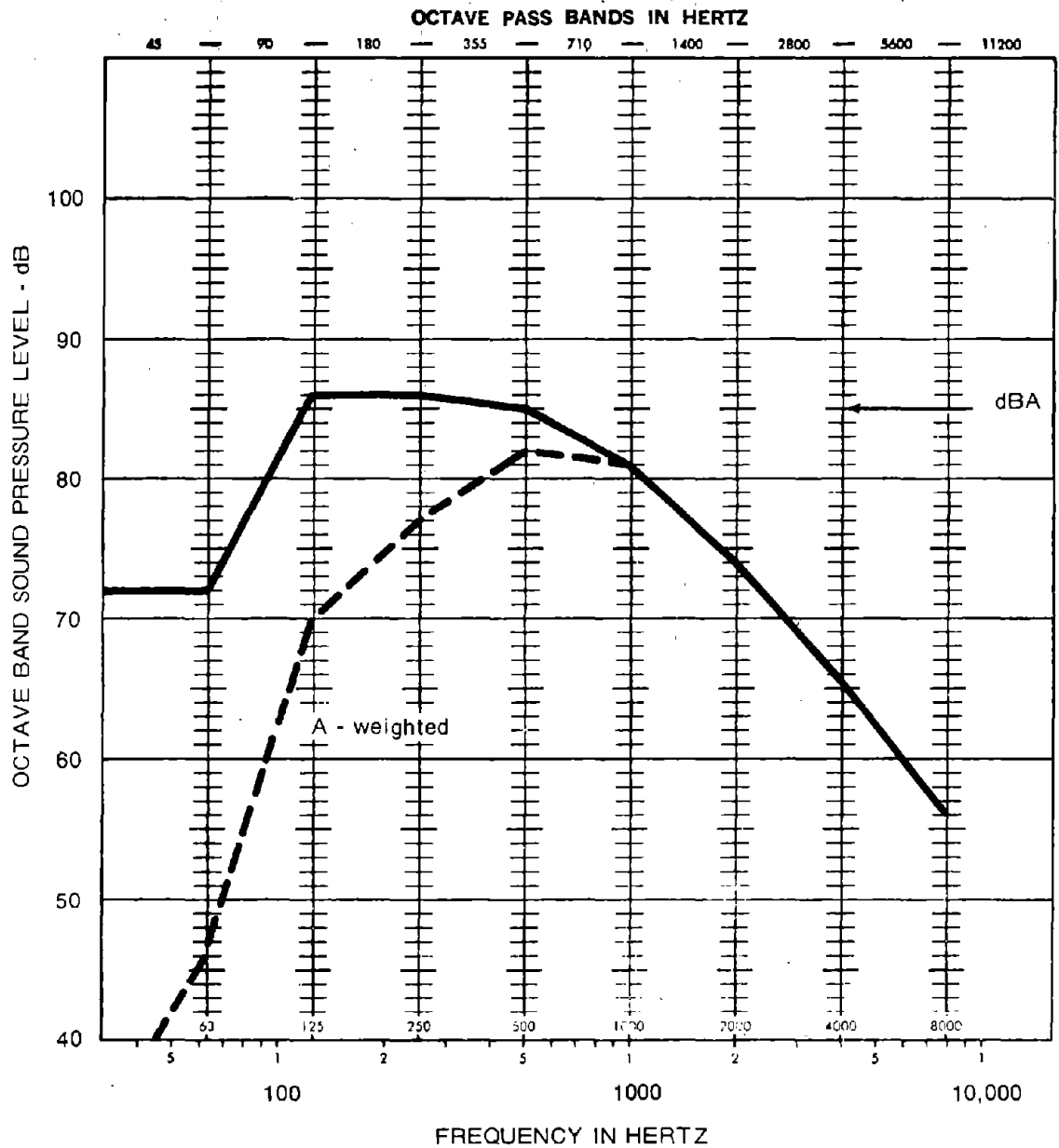

FIGURE 5.3.10 - Operator's exposure in reconstituting room (center of room, ear level of a standing worker to the right of tank # 24)

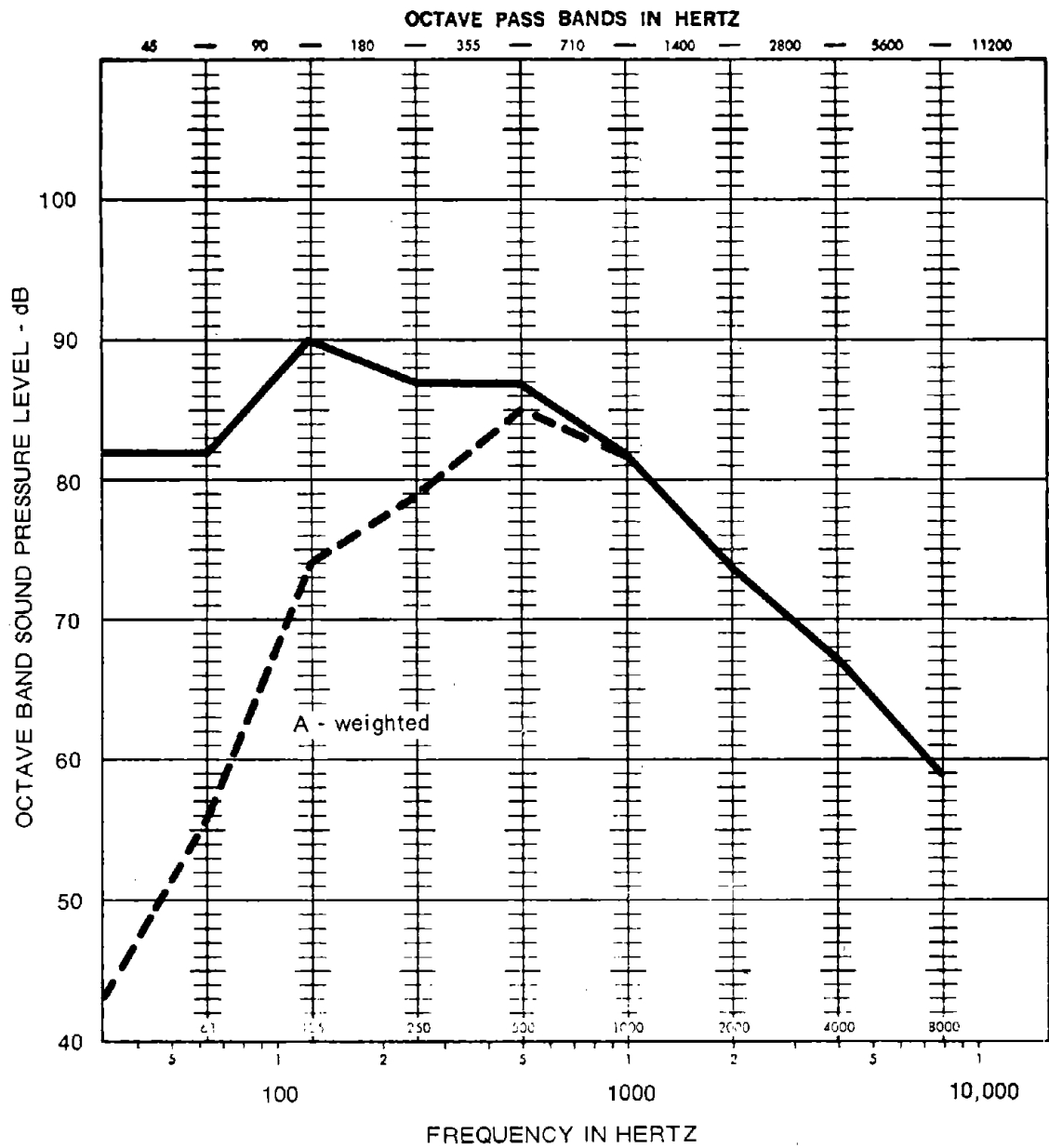

FIGURE 5.3.11 - Noise in reconstituting room, measured 2 cm from bottom edge of exhaust face of refrigeration unit

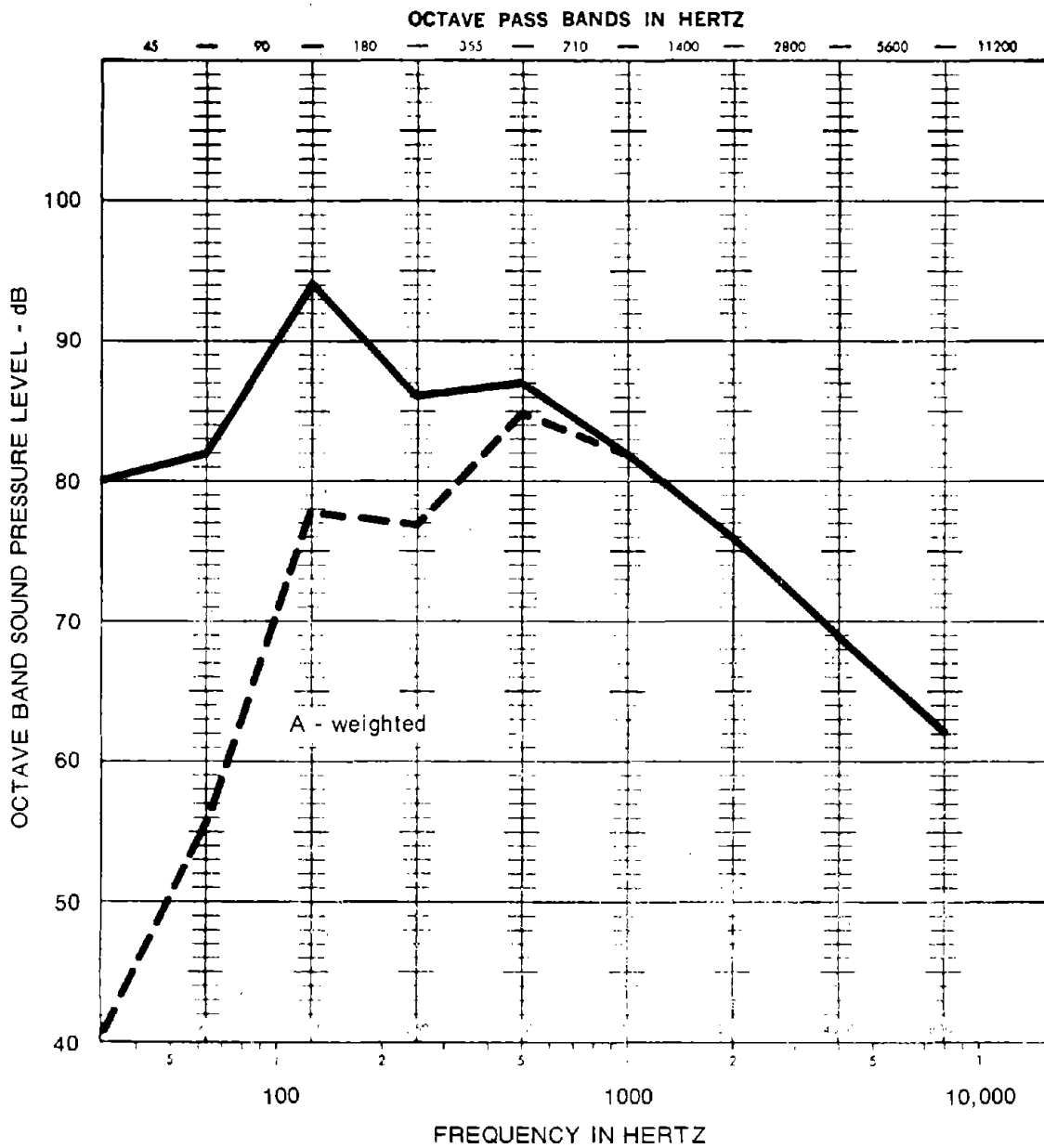

FIGURE 5.3.12 - Noise in reconstituting room, measured 2 cm below rear intake face of refrigeration unit

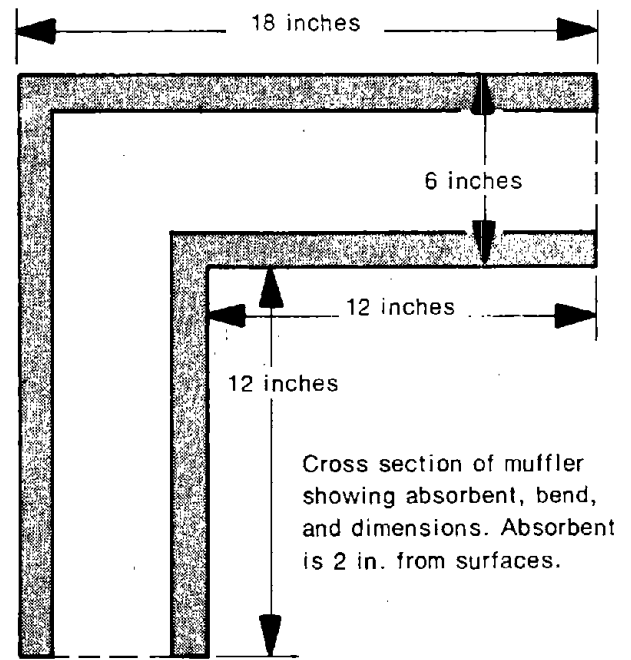
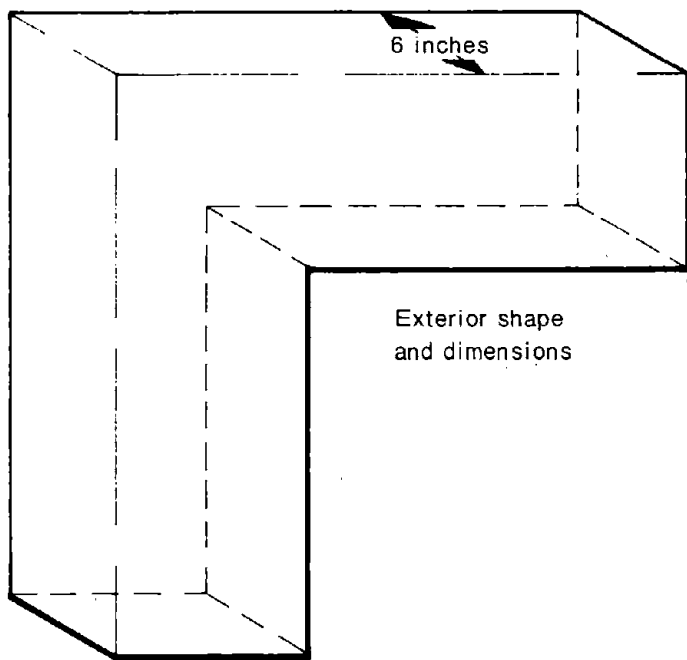

FIGURE 5.3.13 - Motor exhaust muffler

CASE HISTORY #4 - BLANKING PRESS RAM

Description of the Problem

In forming operations, large blanking presses are used. The ram, which is like a connecting rod in a reciprocating engine, is hollow. The forming die runs in grooves on the side of the press, like a piston in the cylinder of a reciprocating engine, and completely closes off the end of the hollow ram. There are slots in the ram that are used normally when the press is used in blanking operation to extricate the work from the die. This is similar to removal of a cookie from a cookiecutter. These slots are in the side of the ram (see Figure 5.4.1). When the press is being used in the forming mode, these slots are not required, and when the die "snaps through", it cuts off the work. This gives rise to high noise levels.

Measurement and Analysis

In a vibration isolated forming press, operator position noise levels were $L_A = 94$ dBA, $L_C = 100$ dBC in the "slow" reading position. An octave band measurement disclosed that levels in the 250-, 500-, 1000-, and 2000-Hz bands were much higher than in other bands. This ringing noise, which had a maximum near 2 kHz, was easily discernible by ear. By careful listening, it was determined that the source was radiation from the slots in the ram.

The technical conclusion was that the ram hollow interior plus slots was essentially behaving as a shock-excited Helmholtz resonator. A Helmholtz resonator is a closed volume of air connected by a tube, which will resonate at various frequencies (like blowing across a glass jug opening).

Control Approaches Considered

The one approach that would obviously work would be to fill the cavity in the ram with rubber-like material. Another approach would be to simply plug the slots and keep the noise inside the ram. The second approach was chosen because it was easy to try and certainly not expensive to test. It would also allow the machine to be easily reconverted to a blanking operation.

Control Approach Chosen

The ram slots were each covered with a plywood plate sealed with a Neoprene gasket, as shown in Figure 5.4.1. Weatherstripping (nonhardening sealant) was used to prevent small leaks. These control measures were easily installed.

Noise Reduction Achieved

The first attempt was satisfactory and achieved a 6-dBA reduction of quasi-peak A-weighted level from 99 to 93 dBA QP. See Figures 5.4.2 and 5.4.3. Applying this to the observed slow A reading of 94 dBA yields the observed 88 dBA.

This case history demonstrates both the simplicity (the solution) and the complexity (the resonator) of noise control. It also demonstrates a more subtle feature: simple solutions are worth trying if there is a good physical reason for them.

Pitfalls

The obvious pitfall here would be to apply this solution to a press that had not first been vibration isolated. If the press were on other than piers isolated from the building, or had sheet metal guards, one would probably not have been able to measure any improvement. Filling the ram cavity would have been another pitfall. It would have accomplished the noise reduction, but would have prevented easy reconversion of the press to blanking operation.

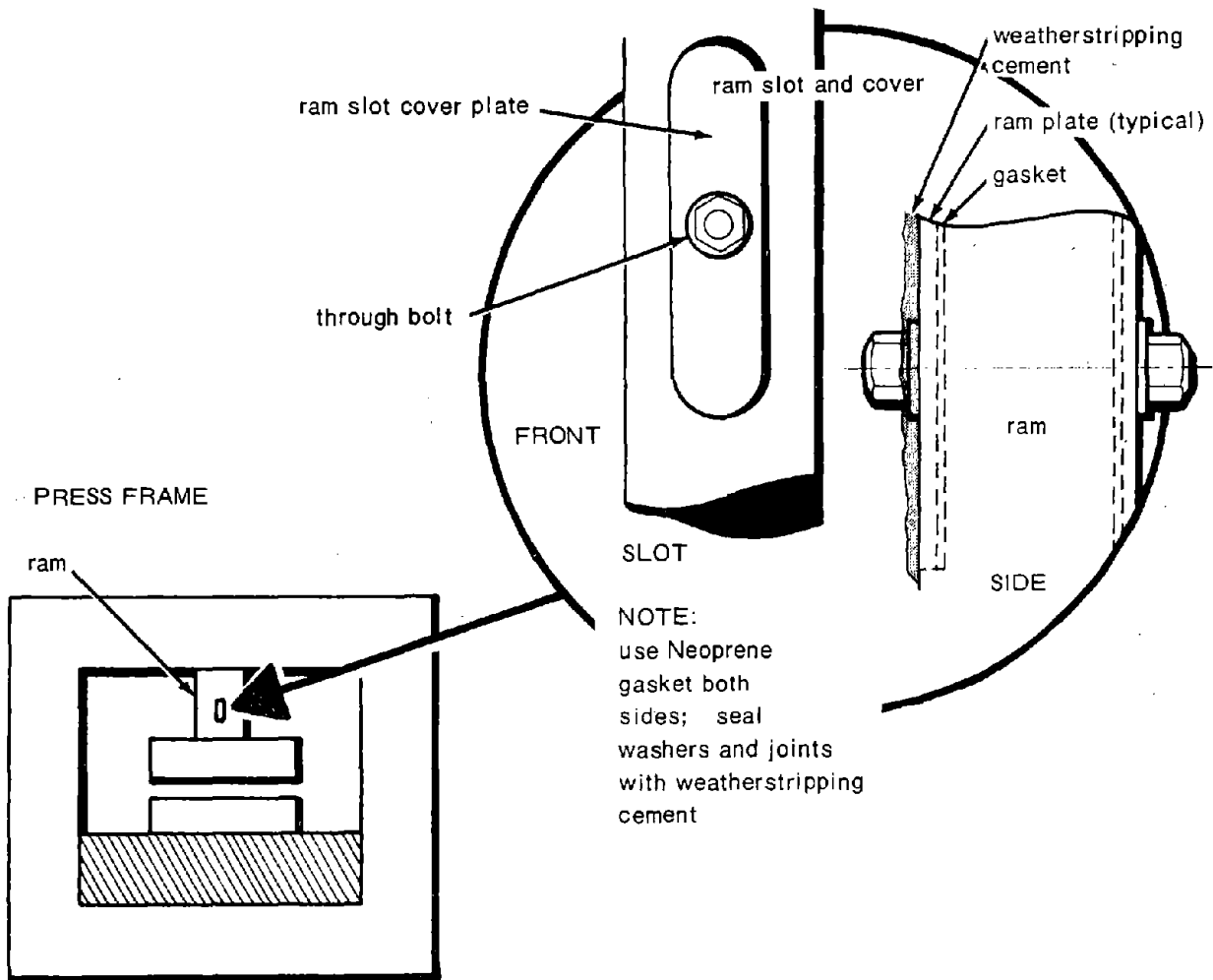

FIGURE 5.4.1 - Method used to cover slots in blanking press ram

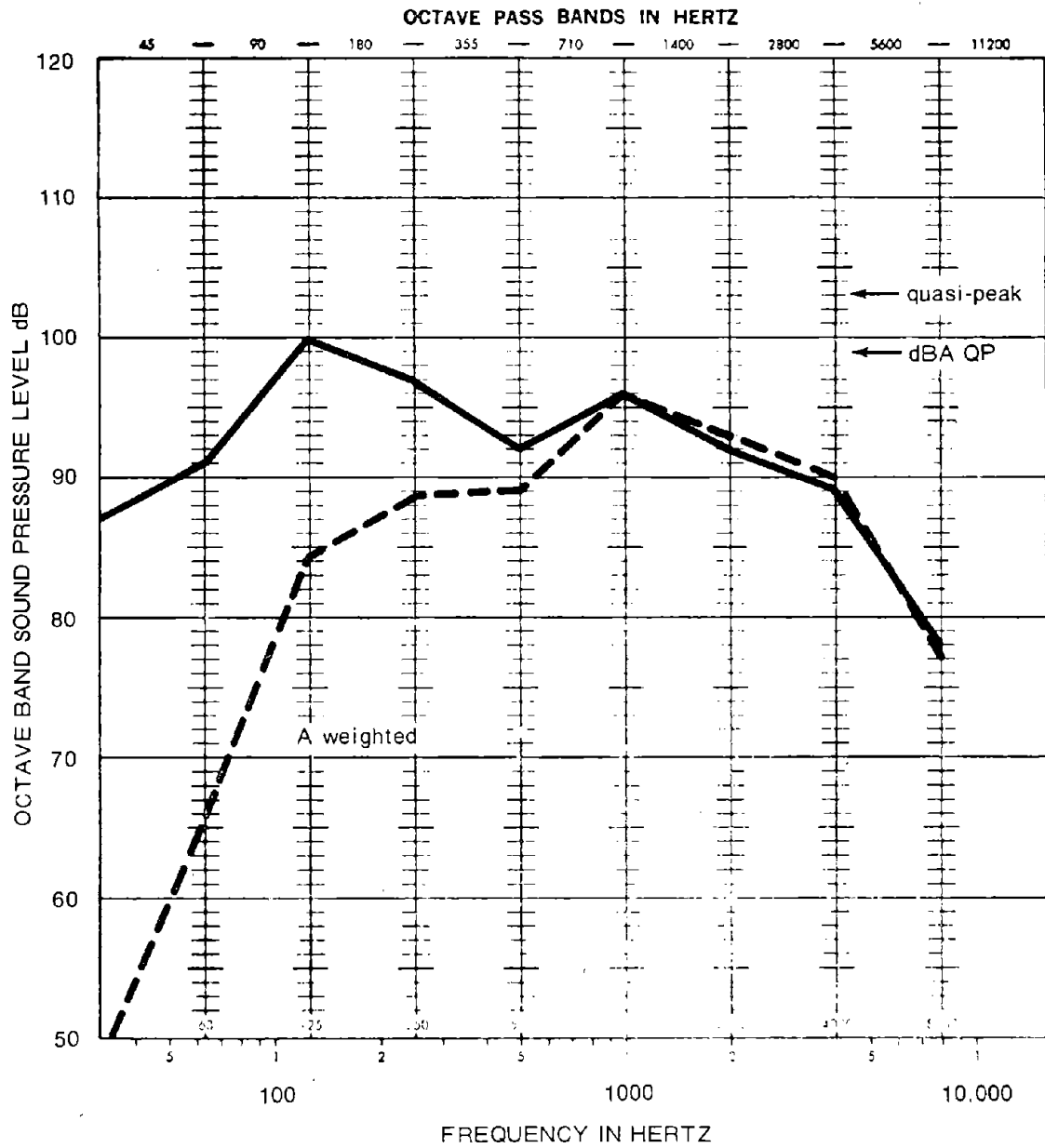

FIGURE 5.4.2 - Quasi-peak readings of blanking press before noise control

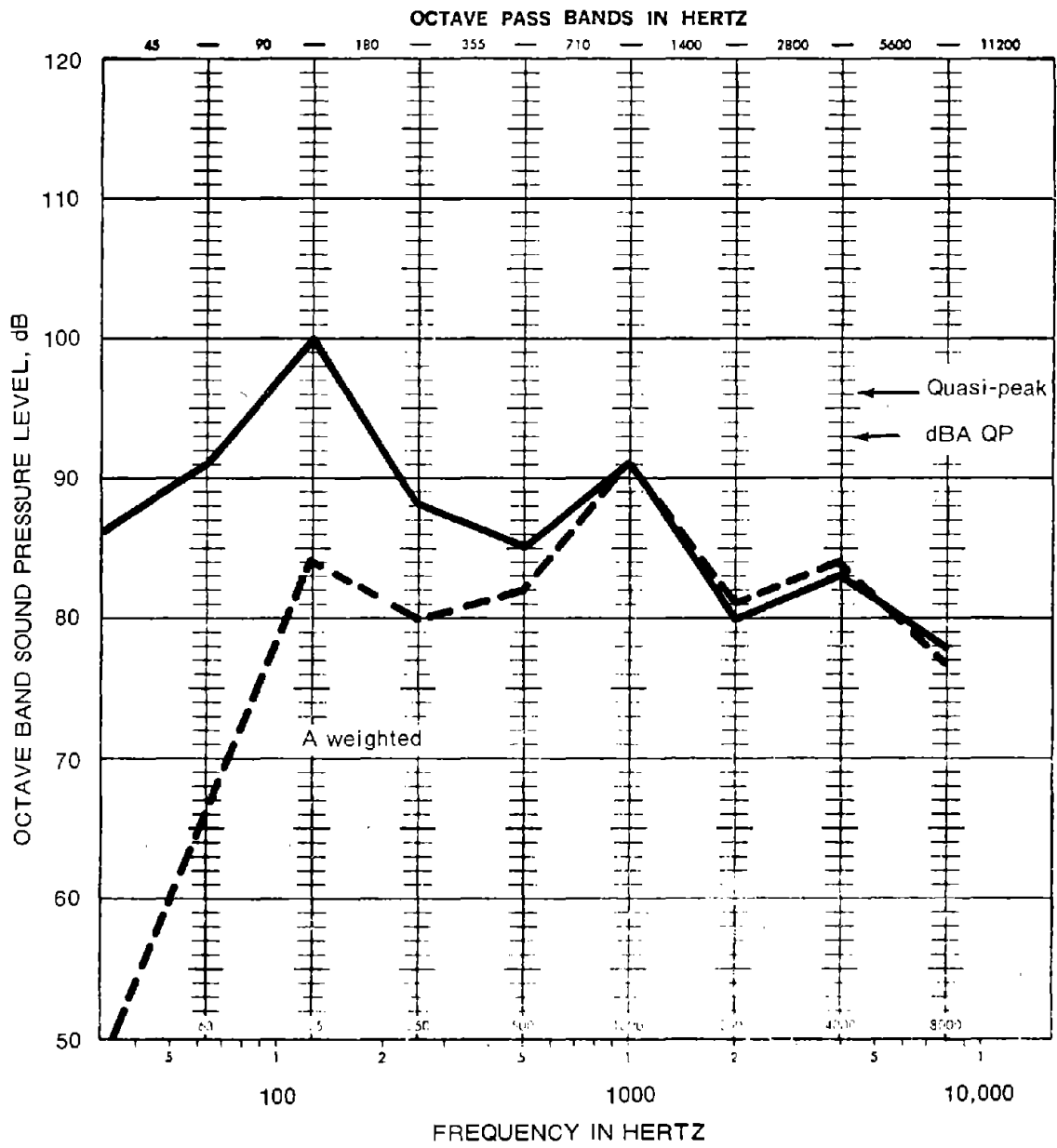

FIGURE 5.4.3 - Quasi-peak readings of blanking press after ram ringing was contained

CASE HISTORY #5 - SPINNING FRAME AIR NOISE

Description of the Problem

Cord manufacturers use a machine called a spinning frame to convert yarn to cord. In the process of spinning this yarn into cord or thread, lint or small pieces of yarn fall away. At each spinning station along the frame, air suction removes this lint by a system that works essentially like a vacuum cleaner. This system requires a rather large air moving system for each spinning frame, and the noise created from these air moving systems causes the ambient noise levels to range from 88 to 93 dBA at the work stations throughout this system. This unit was a Whitins Model M-2.

Measurements and Analysis

Measurements were made with a Type 2 sound level meter. At about 2 cm from the air exhaust of the lint scavenger system, the levels were: $L_A = 100$ dBA, $L_C = 100$ dBC. The major noise source was unquestionably the air escaping from the lint removal system, as was verified by the fact that $L_A = L_C$. This problem is common in high velocity air systems.

Control Approaches Considered

The obvious solution to a problem of this nature is to use a muffler or an acoustical isolator. However, a more fundamental approach considered was to slow the escaping air at the scavenger exhaust. This could be accomplished by simply giving the exhaust vent a bigger open area, as shown in Figure 5.5.1. The velocity of the escaping air was estimated to be 115 ft/sec (the fan moved 1800 cfm through an area of about 37 in.²). To simply open the fan cover was not practical, since the air must be directed upward.

The reason this control approach is a good one to consider can be best summarized in the following relationship:

$$X = 10 \log_{10} (V_o/V_n)^5$$

where X is the reduction in decibels

V_o is the original air velocity

V_n is the new air velocity.

This equation is widely used by noise control engineers to estimate the relative noise reduction if air stream slowdown is possible.

Our design increased the area through which the air exhausted by a factor of 10: from 0.26 ft² to 2.6 ft². Because the flow is practically incompressible, $V_o/V_n = 10^{-1}$ and $X = 50$ dB reduction. However, the net noise reduction will ordinarily be less because other noise sources are still present. A useful rule of thumb is to expect a useful reduction of at most 10 dB if a major source is completely removed. The chief exception to this is the intense and often high frequency pure-tone single source, such as a whistle, steam vent, or automatic control valve.

Noise Reduction Achieved

The noise was measured, with all but one fan cover unchanged; it was $L_A = 93$ dBA and $L_C = 94$ dBC, a reduction of 7 dB in A-level. It is thought that this reduction fairly well represents the background level without this fan running.

Pitfalls

The most common pitfall in a treatment of this kind is to attempt to do a makeshift or sloppy final job. Care must be taken for the final result to be effective. A professional metal shop can fabricate the device shown in Figure 5.5.1 much more easily and, certainly in quantity, much less expensively than it could be fabricated in your plant. The rubber gaskets and sealant are both important to the overall effectiveness of the job.

This kind of noise control is certainly straightforward and is not expensive. The cursory results reported here make it well worthwhile. The plant for which this was designed will no longer find it necessary to require hearing protection for its workers.

NOTE:

- 1 - for final assembly, seal all gaskets with nonhardening weatherstripping cement
- 2 - make certain existing fan cover is strong enough to support modification

vent - muffler, to be designed and attached only if required

new air exhaust stack, directs air upward to vent - muffler

existing fan cover, modified to accept new air exhaust stack

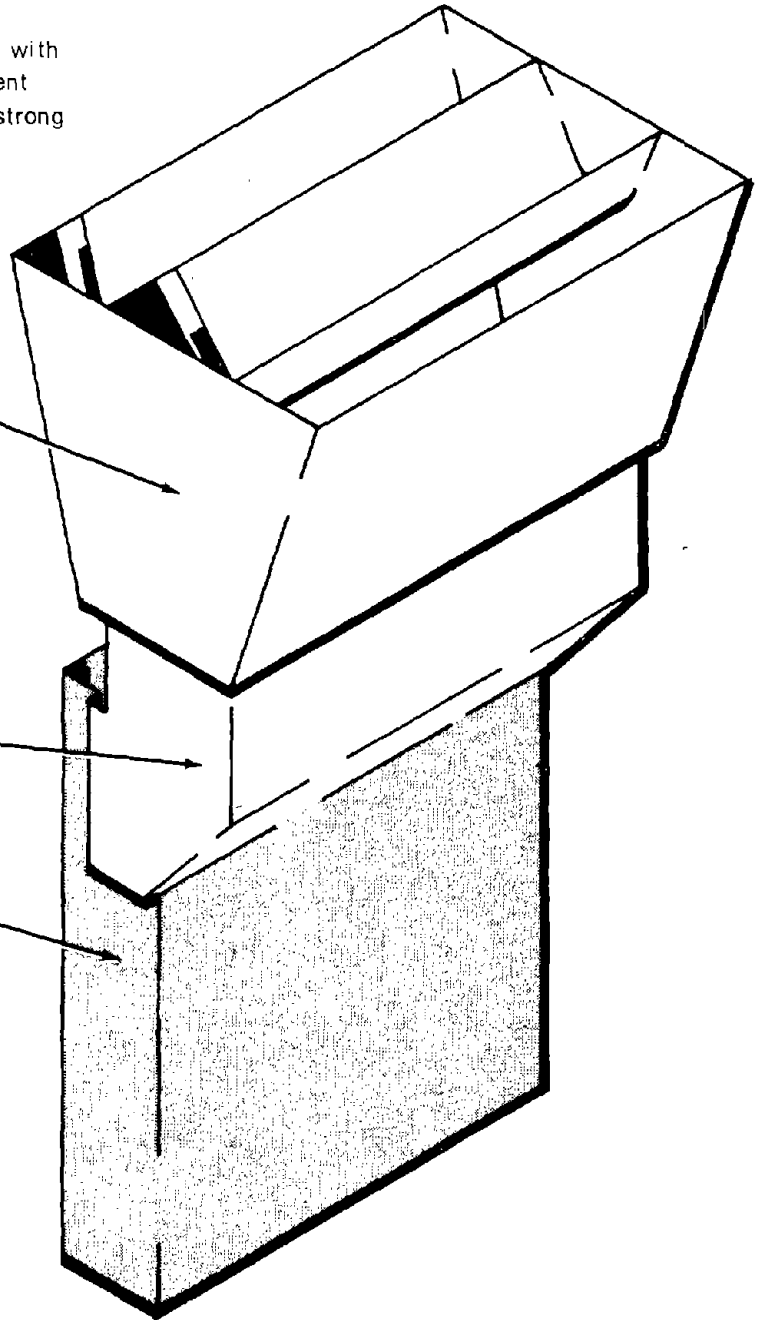

FIGURE 5.5.1 - Air exhaust vent modification for spinning machine noise control

CASE HISTORY #6 - BARLEY MILL

Description of the Problem

Excessive noise levels existed around Moorspeed and Ross barley mills (rolls 8-inch-diameter, 15-inch-long), a hay shredder, and a control operator's chair in a cattle feed grinding mill. The objective was to reduce the noise level at the operator's position for OSHA compliance.

Measurements and Analysis

A and C level and octave band measurements were made between the Moorspeed and the Ross mills (Figure 5.6.1) and at the hay shredder with both mills in normal continuous operation (Figure 5.6.2). With $L_C - L_A = 9$ dB, excessive low frequency noise levels were predicted. These were confirmed by octave band measurements. Octave band measurements at the control operator's chair are shown in Figure 5.6.3. A sketch of the room showing the relative locations of the equipment is shown in Figure 5.6.4.

Control Approaches Considered

Roller crushing actions produced high noise levels, and correction by machine redesign was believed to be too costly a method for solving this problem. When the source is too difficult or uneconomical to attempt to correct, working on the noise path will often result in a more economical solution. Therefore, a partial enclosure, open at the top, was chosen.

Control Approach Chosen

Although walls can be of solid construction with a minimum of access doors, in this case access was needed for adjustment, maintenance, repair, and roll replacement. For roll replacement, a forklift truck entry was required. For ease of quick access, a fixed barrier wall was discarded in favor of a lead-vinyl curtain wall extending, if required, up to the 17-ft height of the roof support beams. All three noise sources could be enclosed by two curtain walls enclosing the corner of the building as shown in Figure 5.6.4. The curtains run on rails for easy sliding back and are held together by Velcro closures.

Figure 5.6.1 shows that, if the sound levels from 250 Hz up are reduced by at least 14 dB, the resulting A-level readings would be less than 90 dBA for compliance outside the curtain walls.

Barrier wall attenuation is limited in three ways: (1) direct transmission loss in each octave band, (2) noise over the wall, and (3) room absorption, noise-source side.

(1) Direct transmission loss (TL): The manufacturer of lead-vinyl fiberglass curtains, 0.75 lb/sq ft, was chosen. Manufacturer's literature gave the transmission loss in each octave band as follows:

	<u>125 Hz</u>	<u>250 Hz</u>	<u>500 Hz</u>	<u>1000 Hz</u>	<u>2000 Hz</u>
TL =	11 dB	16 dB	20 dB	26 dB	31 dB

It is seen that the transmission loss is not a limiting factor.

(2) Noise over wall: Barrier wall attenuation can be estimated from data in Noise and Vibration Control, Leo L. Beranek, page 178, using the dimensions from Figure 5.6.4 and from the sectional view in Figure 5.6.5.

$$N = \frac{2}{\lambda} (A + B - D) = \frac{2}{\lambda} (16.6 + 16.6 - 18)$$

$$N = \frac{30.4}{\lambda} \text{ (Fresnel number)}$$

	<u>125 Hz</u>	<u>250 Hz</u>	<u>500 Hz</u>	<u>1000 Hz</u>	<u>2000 Hz</u>
λ =	9.6 ft	4.8	2.4	1.2	0.6
N =	3.2	6.3	12.6	25.2	50.4

Attenuation (dB)	14	16	18	20	20
------------------	----	----	----	----	----

(from graph page 178, Beranek). In practical situations, the attenuation is limited to about 20 dB.

By a rough first approximation procedure we can obtain an estimate of the reduction afforded by the curtain walls. In the listing below we start with the worst-case octave band levels of Figure 5.6.2 and then list the transmission loss and barrier effects just calculated. Subtracting the minimum of these two reduction mechanisms yields a tentative spectrum of the resulting sound in the room. After A-weighting and combining levels, the predicted reduced room level is 84 dBA.

Octave bands	125	250	500	1000	2000
Noise source	106	101	98	97	90
Direct TL	11	16	20	26	31
Over wall	14	16	18	20	20
Reduced levels	95	85	80	79	70
A-weighting	-16	-9	-3	0	1
A-weighted	79	76	77	77	71
A-level	84 dBA				

For visual access the enclosure can have 10 x 20-inch plastic windows placed to order; use only minimum number. The curtains should be long enough to drag a bit on the floor to reduce leaks. Some rerouting of power, steam, and air lines may be required.

The approximate 1973 costs were: \$4.00/ft² for curtains made to order with grommets; Velcro fasteners, \$3.00/ft; track, \$1.50/ft; rollers (one per grommet), about \$2.50 each; windows, \$25.00 each; total cost about \$4,000.

The preceding simplified treatment neglects an important fact: we have not gotten rid of the noise, but have merely redistributed it. Thus, the total sound power from the machines escapes from the topless enclosure and spreads throughout the room. Close to the curtains, there should be some reduction, but very little farther away. Absorption is required to actually reduce the sound power. This was next considered.

(3) Absorption, noise-source side of wall: When noise sources are confined to a space with less absorption than before, they may build up higher levels due to reverberation. The sound barrier curtain material can be obtained with sections of sound absorbent on the inside, to counteract this effect. In the barley mill, however, this was not recommended as the porous open material could easily become dust clogged. Shortly after this noise control job was completed, absorbents covered with a plastic film became available. At the time the recommendation was for an easily installed and maintained material, Owens-Corning Fiberglas Noise Stop Baffles. These are 23 x 48 x 1.5 inches and comprise an absorbent board wrapped in a washable, noncombustible plastic film; each baffle is supplied with two wires through the 23-inch dimension. These wires terminate in hooks; to install, stretch wires, three feet on center, parallel to the line joining the two mills and about flush with the top of the enclosure rails. The baffles are available through local acoustical material suppliers. The cost is about \$10.00/baffle.

The enclosure developed by the curtain walls is in effect a separate small room, and the noise reduction can be estimated from the relationship of total absorption before and after adding the sound absorption panels. This relationship is

$$\text{dB Attenuation} = 10 \log a_2/a_1$$

where: a_2 is new total absorption
 a_1 is original absorption

(from reference: Harris Handbook of Noise Control, pages 18-19).
 Original absorption, a:

	Area	x	Coeff.	=	Abs. (sabins)
Long wall	32' x 17'	x 2	x 0.02		22
End wall	17' x 17'	x 2	x 0.02		11
Roof	17' x 20'	x 1	x 0.02		7

Absorption by adding 100 panels 2 x 4 feet:

100 x 2' x 4' x 2 sides x 0.8 (average A-weighted
 absorp. coeff. of
 panel) = 1280

Original absorption 40

New total absorption 1320

$$\text{dB attenuation} = 10 \log \frac{a_2}{a_1} = 10 \log \frac{1320}{40} = 15.2 \text{ dB}$$

Resultant level = measured level - reduction = 86 dBA.

Noise Reduction Achieved

The measured final noise level was 87 dBA, giving a 7 dBA reduction. This was 3 dBA lower than the maximum desired level, and was the result of paying careful attention to elimination of leaks. The room formed by the curtain did not realize such a reduction, but since these machines required no attention while running, the noise exposure of personnel was significantly reduced below $D = 1$. The major remaining path is reflection from the ceiling.

Pitfalls

Barrier walls of various heights can often be used between a noise source and a machine operator. A major pitfall is that, in a

room with a high level of reverberant noise, the partial barrier will be short-circuited by the reflected noises from walls, ceilings, and other surfaces. In such cases, attenuation based on the partial wall theory will not be obtained, often resulting in no attenuation at all in highly reverberant rooms. Curtain walls must be kept closed to get attenuation. Sound absorbing units must be kept clean to be efficient.

Even in a semireverberant room, a reduced barrier height can be used. In this case a 7-ft barrier should ideally reduce the level to 89 dBA at the receiving location. However, since the semireverberant conditions will introduce more reflected sound with the lower barrier, the high wall used in this case history is recommended because the added absorption within the barrier area has, in effect, made a separate small room and created the condition on which the barrier wall theory was based.

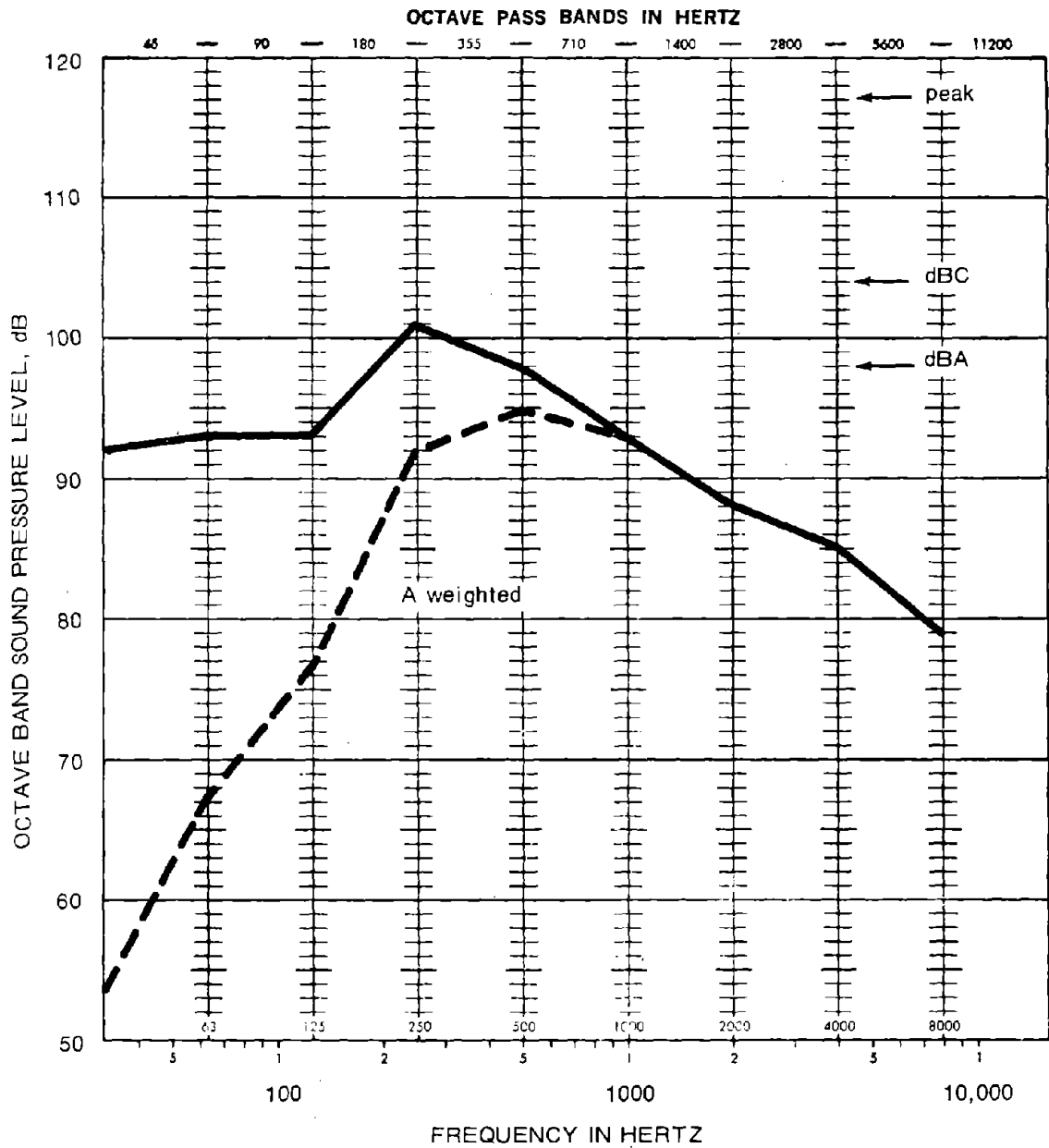

FIGURE 5.6.1 - Barley mill noise levels, measured between Moorspeed and Ross mills (4 m out, 1 m up, both mills on)

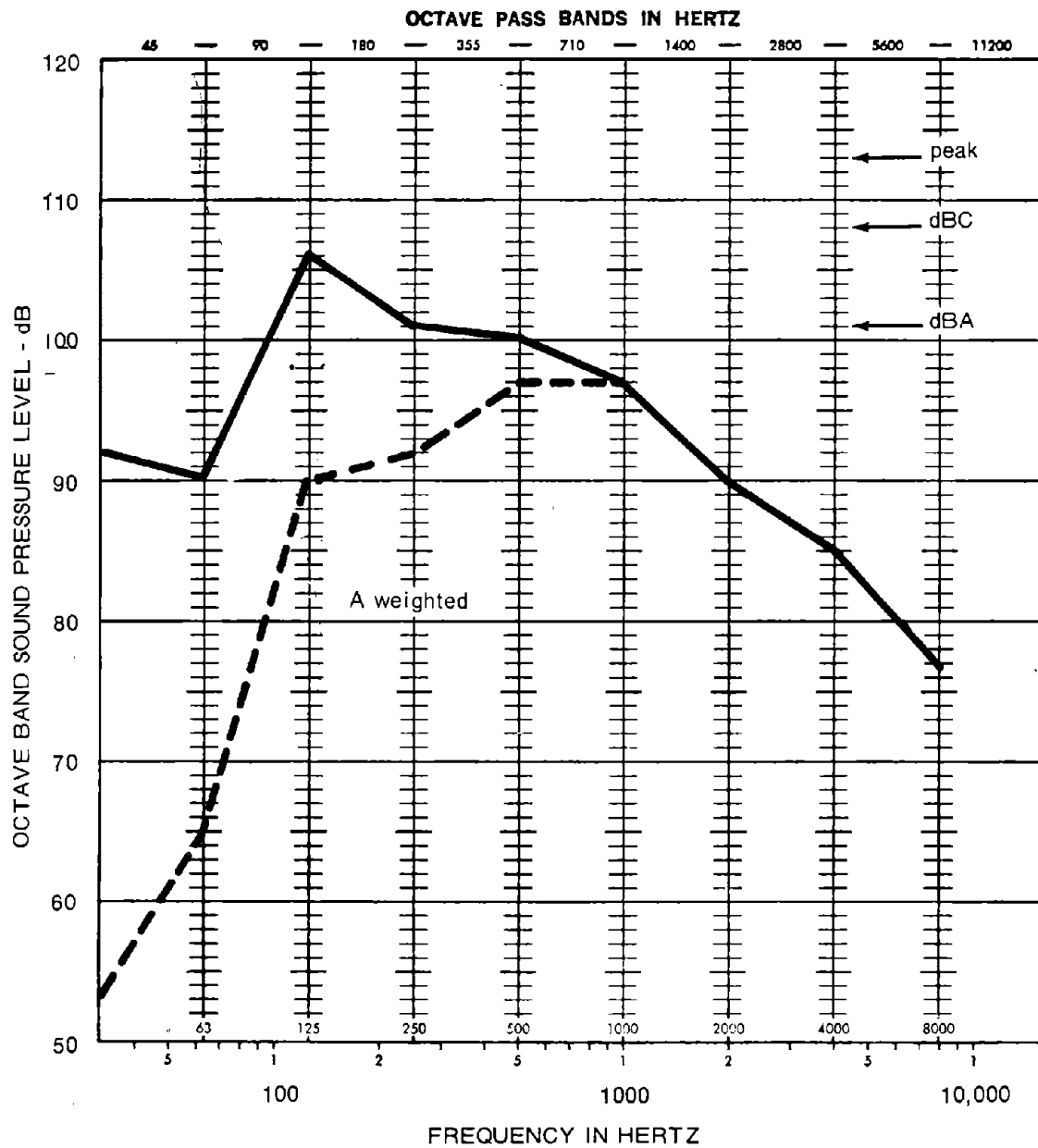

FIGURE 5.6.2 - Barley mill noise levels, measured at guard rail of hay shredder (2 m opposite blower, both mills on)

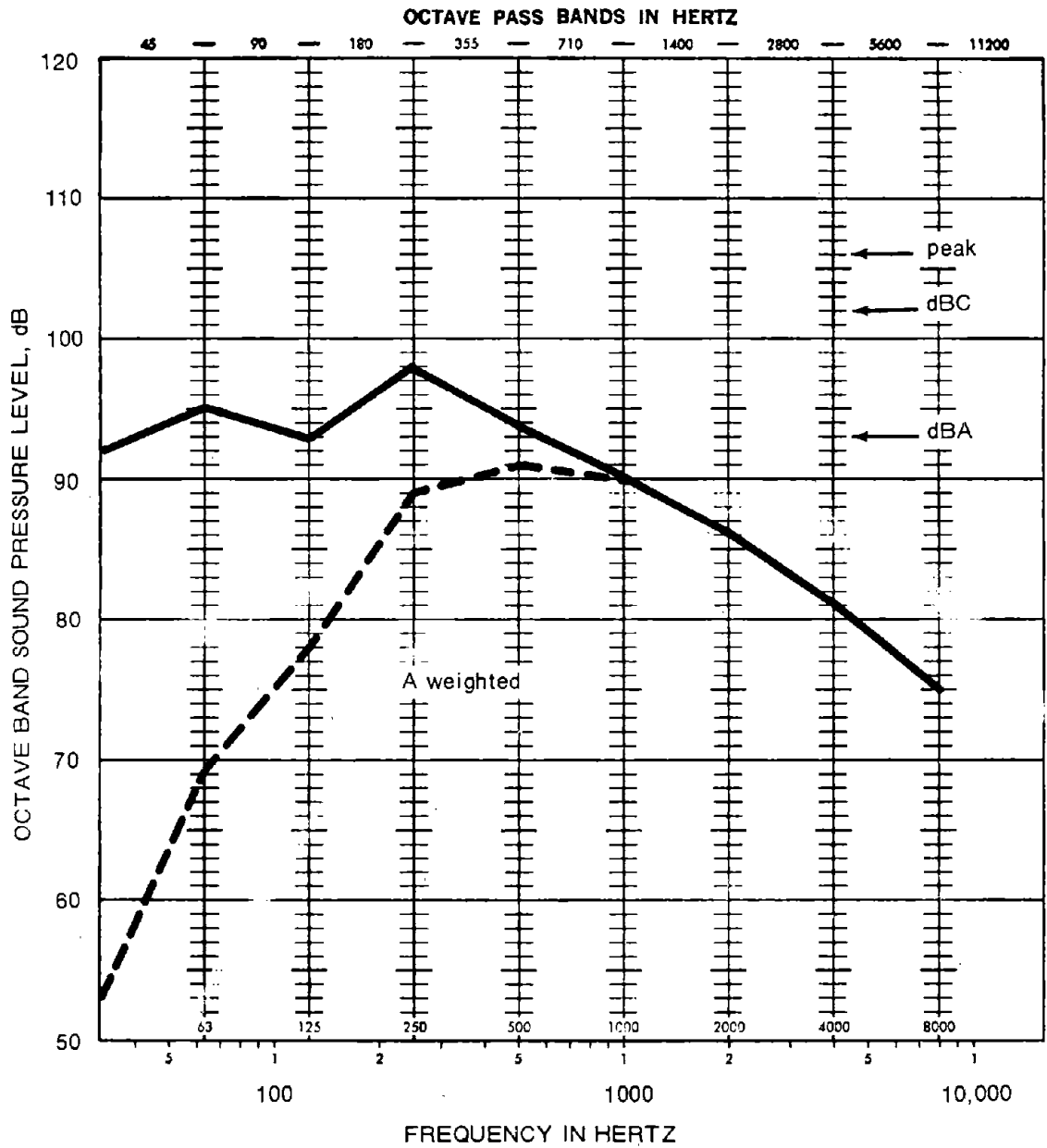

FIGURE 5.6.3 - Barley mill noise levels, measured at control operator chair (ear level, operator absent)

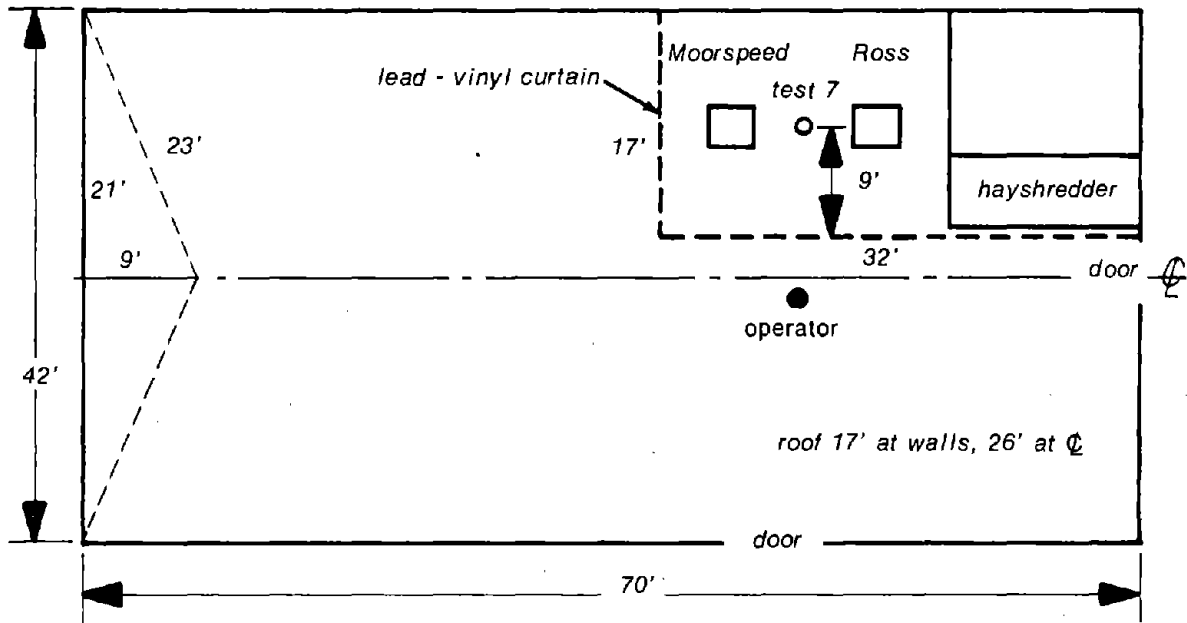

FIGURE 5.6.4 - Floor plan of barley mill

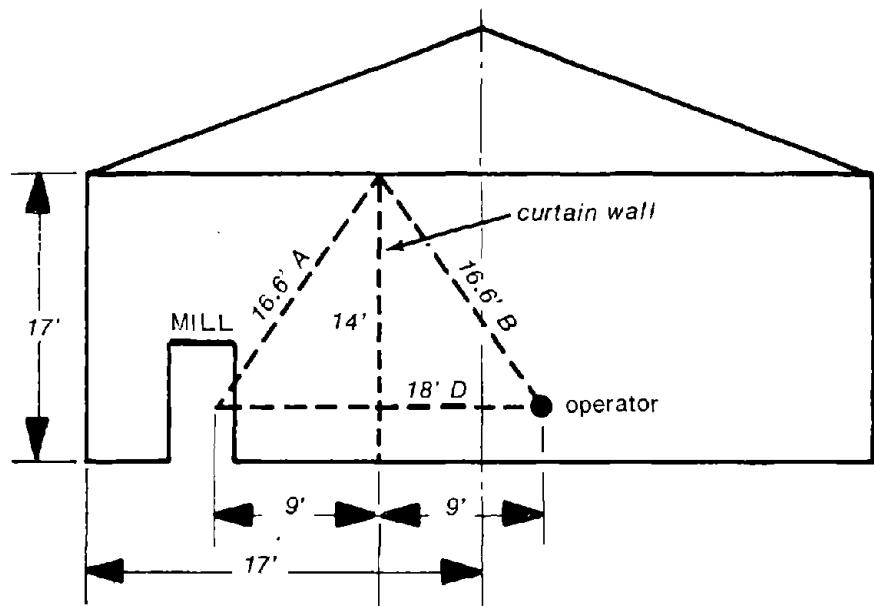

FIGURE 5.6.5 - Sectional view of barley mill

CASE HISTORY #7 - SHEETER FOR BOXBOARD

Description of the Problem

The sheeter, starting from large rolls of boxboard about 6 feet in diameter, cuts the web to length using a rotary knife that can be adjusted to rotary speed, and therefore sheet length, by means of variable speed drive (Reeves Drive). The cut sheets are delivered to pallet. The speed is about 700 ft/min.

Measurements and Analysis

At the operator control station near the sheeter (see Figure 5.7.1), the noise level was found to be 93 dBA. Close-in probe readings at the variable speed drive were high, indicating that the drive is a major noise source. Readings were as follows:

- 96 dBA close to front drive guard, in aisle.
- 98 dBA close to front drive guard, in aisle 3.
- 105-107 dBA close to front drive vent openings.

The drive box enclosure was a steel shell 6 ft high, 3.5 ft wide, and 3.5 ft deep, having two vent openings in the side for natural air cooling (see Figure 5.7.2).

Other operator locations that were far from the drive were checked:

- 90 dBA operator at delivery
- 88 dBA operator at rollstand in feed (see Figure 5.7.3 for general layout).

From the close-in readings, the drive was determined to be the major noise source and not the roll unwind stands, rotary cutter, or delivery belts to finished pallet of boxboard.

Control Approach Chosen

To reduce the drive noise within the steel box enclosure, it was decided to line the interior walls with an acoustic absorbing polyurethane foam with a layer of 0.017-inch-thick sheet lead to provide damping of the steel surface panels. To reduce the noise coming out of the air vents, an acoustic traps was designed to absorb the noise at vent but allow full normal air circulation. This acoustic trap is shown in Figure 5.7.2.

Noise Reduction Achieved

The level at the operator control panel near the drive unit was found to be 89 dBA, reduced from 93 dBA. In addition, some reduction was obtained in other operator positions:

86-87 dBA from 90 dBA operator at delivery.
86 dBA from 88 dBA operator at roll stand.

Close readings at vents were reduced to 94 dBA from 105 dBA; this is not an operator position.

Sound absorbing polyurethane foam with a lead septum designed for combined damping and absorption is available from various suppliers at less than \$4/ft²; material cost was about \$400, and in-house labor to glue in place and fabricate a holder for the sound trap was about another \$400; total cost was about \$800.

The polyurethane sound absorbing material shows a 0.90 absorption coefficient at 1000 Hz and above. Although the absorption coefficient at lower frequencies is less, the effect of increasing A-weighting with decreasing frequency makes the loss of absorption at lower frequencies less important.

Pitfalls

Without close-in reading to locate the drive unit as the major noise source, we could have jumped to the conclusion that the entire sheeter, including the drive unit, must be installed in an acoustic enclosure, thereby spending a great deal more money for the solution.

This kind of noise reduction is typically not as satisfactory as one would like. The major problem that can arise is the existence of other direct sound paths from the knives to the operator.

Another pitfall for sheeters is the knife design. Some of the older models have straight knives instead of an angular striking or cutting edge. Straight knife sheeters will probably require an acoustic absorbing lined metal or wood hood over the knife assembly and perhaps under the knife assembly.

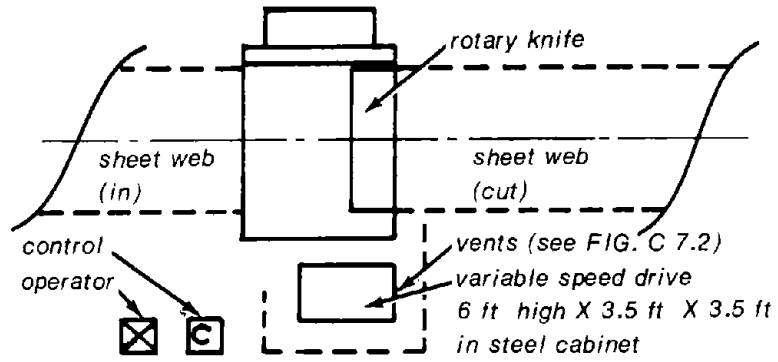

FIGURE 5.7.1 - Floorplan of sheeter for boxboard

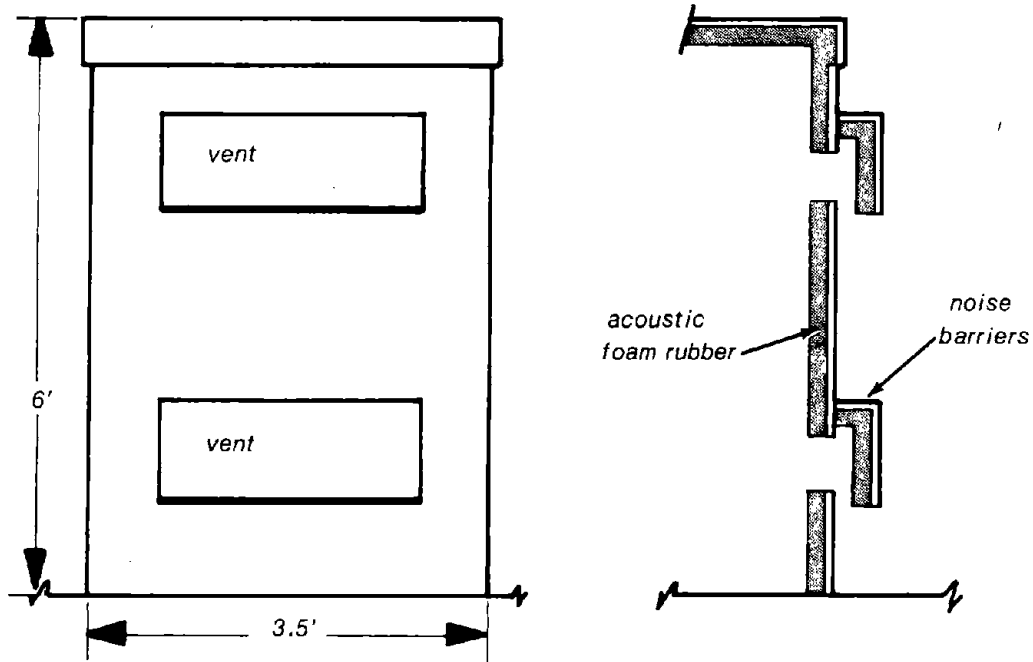

FIGURE 5.7.2 - Sheeter drive box enclosure

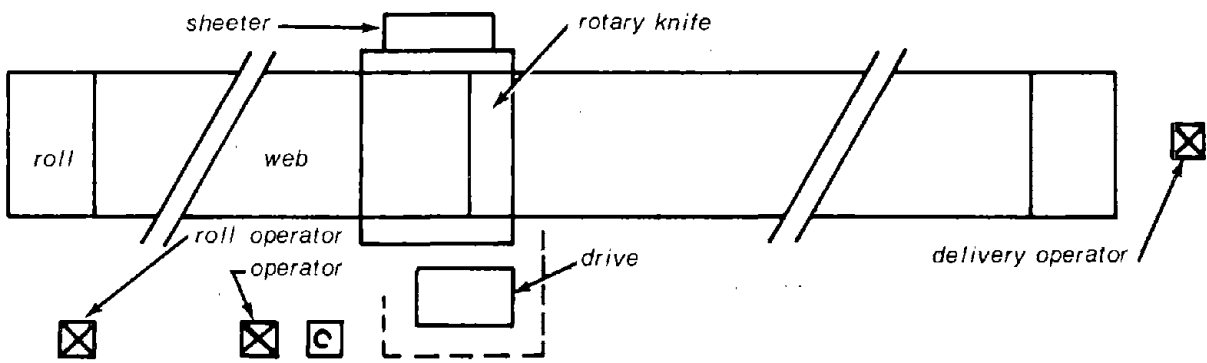

FIGURE 5.7.3 - Layout of sheeter and operators

CASE HISTORY #8 - AIR SCRAP HANDLING FROM BOBST CUTTING PRESSES, FOLDING CARTON MANUFACTURING

Description of the Problem

In the folding carton industry, printed sheets are cut on Bobst and similar cutting presses, equipped with automatic strippers for removal of waste material between cartons. When the press is operated and is in good mechanical adjustment, there is no serious noise problem. Often, however, noise from the scrap disposal system results in levels above 90 dBA on the pressman platform.

This popular scrap disposal system (see Figure 5.8.1) used a horizontal air vane conveyor to move the scrap from under the stripping station to the intake of a centrifugal fan that pushes the scrap to a baler or to bins at a baler in a remote location.

The noise problem arises from the pieces of paper scrap striking the sides of the intake conveyor under the press stripper, the sides of the intake hood to the fan, and the fan and outlet ducts. These all contributed noise that resulted in noise levels of over 90 dBA at the pressman station. Depending on amount of scrap and size of pieces, the noise level reached 95 dBA each stroke of the press, normally making the noise almost continuous.

Measurement and Analysis

In this type of problem, it was not considered necessary to make octave band measurements when simple direct sound level readings would tell the story of the obvious problem before and the results after damping. Octave band levels aid in determination of the noise source, but in this case the noise source was known and before and after levels could be expressed in dBA.

Control Approach Chosen

The sheet metal of the stripper intake, fan intake from horizontal air vane, the fan, and outlet ducts were all damped (and transmission loss improved) by gluing a layer of lead sheeting to the outside surfaces, using a resin glue recommended by supplier of sheeting. Sheetting used was 1/32-inch thick, 2 lb/sq ft.

Other sheet damping materials that are on the market could have been used as effectively, as discussed below.

Noise Reduction Achieved

The damping of the sheet metal reduced the noise level at the pressman platform to 88 to 90 dBA.

The concept of using sheet lead to damp the sheet metal ducts came from supplier literature citing successful sheet metal damping on ducts and fans and other surfaces. (Cost is about \$0.90/ft².) For less damping, a 1 lb/ft² material may be used at \$0.46/ft². For minimum damping, stiff roofing felt may do. For even greater damping, there are many products on the market in sheet form and tape form. Suppliers can be consulted on specific problems; prices range from \$1.50 to \$3.50/ft².

For very high vibration and noise levels, a further duct treatment step would be lagging, which is a spring-absorber-mass combination of 1 to 3 inches of resilient acoustic absorbing material (Fiberglas or polyurethane) with a heavy cover sound barrier of sheet lead or lead-filled vinyl sheeting over the entire surface. See Case History #9 for an example of this method.

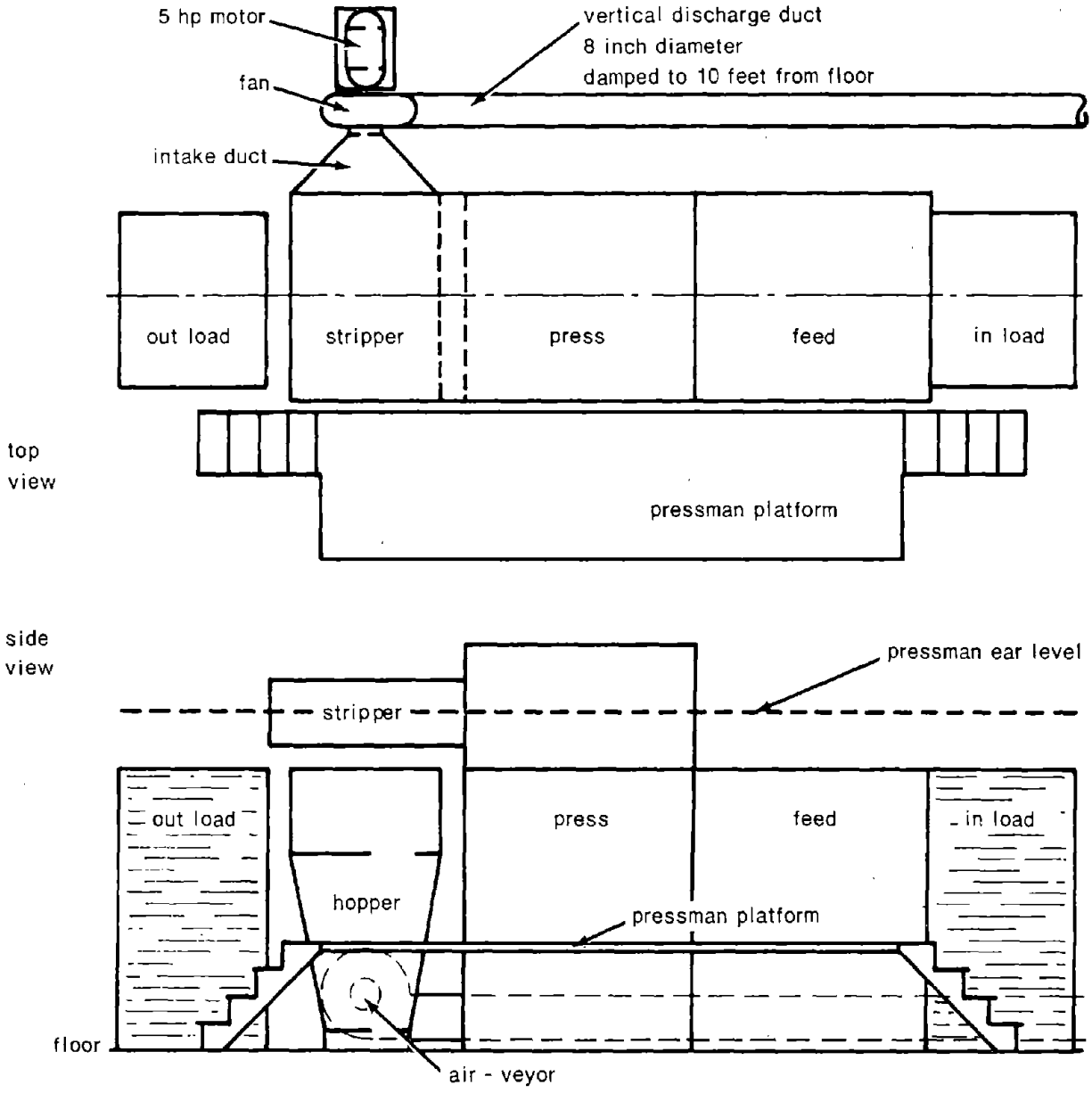

FIGURE 5.8.1 - Scrap handling system for cutting press

CASE HISTORY #9 - JORDANS FOR PAPER MILL FOR BOXBOARD

Description of the Problem

In a boxboard waste paper mill, Jordans are used to refine the waterborne pulp. A Jordan consists of a conical shell and rotating conical plug, both with steel blades on their mating surfaces. The refining action can be adjusted by decreasing the spacing of the revolving cone to the stationary cone within the limits of power available from the drive motor. In this case, drive motor power is 500 H.P.

The action of the Jordan refiner results in high noise levels, as shown in Figure 5.9.1. With maximum refining power the noise level was found to be 97 dBA at the aisle (102 dBA one foot from Jordan surface) during start-up with only one Jordan in operation. As normal operation required six of the eight Jordans in operation with varied power settings, depending on degree of refining required, the operating noise level in the aisle was often at about 100 dBA. Although the paper maker did not have to be in the area continuously during the shift, he was required to make periodic adjustments, which took more time than the maximum exposure of 2 hours at 100 dBA permitted by current regulations. Some noise reduction was therefore required.

Measurement and Analysis

It was determined from vibration measurements that the major vibration surfaces were the conical shell, end cover plate, and outlet box. Shell acceleration measurements were made with a hand-held pickup attachment to the sound level meter to determine the major vibration surfaces as summarized below:

<u>Areas selected for treatment</u>	<u>Vibration (g)</u>
Shell surface, large end	15.9
Shell surface, rib	20
Flange face	10
Shell surface, center	15.9
Shell surface, rib	11.2
Shell surface, small end	5
Outlet box	7.9
<u>Areas not treated</u>	
Bearing support	2.5
Overhead piping	1
Drive motor and bell (1)	0.9
Drive motor and bell (2)	1.4

A-level noise readings only were obtained because octave band data would not have added any information for these purposes.

Control Approaches Considered

Two possible solutions were considered: (1) complete enclosure and (2) partial lagging of Jordan shell. Total enclosure of each Jordan was possible but was not considered as practical as lagging because there were eight Jordans near each other, because adjustment and maintenance would create additional problems, and because the customary sound absorption material inside the enclosures would not be compatible with the wet conditions of this paper mill. Partial lagging was chosen since it could be installed on the major vibrating surfaces producing the noise. Separation of lagging could be designed to allow for maintenance dismantling of the front face and plug. The noise absorbing material of the lagging could be covered with layers of sheet lead, taped to form a water-resistant surface that would withstand cleaning normal to paper mills.

The lagging consisted of a resilient (and absorbing) layer of 3 inches of TIW fiberglass, covered by an impervious and heavy layer of lead sheeting to serve as the mass element and to contain the noise. In theory, a 1-lb/sq ft lead sheeting, perfectly covering the area, would give an attenuation of 24 dB at 500 Hz and 28 dB at 1000 Hz. From a practical standpoint of making a more impervious continuous barrier for both noise and water from cleaning hoses, two layers of lead were used, each layer taped for tightest joints under the conditions of use.

Alternate materials could be considered: the absorbing layer could be polyurethane foam, and the barrier layers could be lead-filled vinyl. However, the fiberglass is much more resilient, and thus is preferred.

In another paper mill, a third method was chosen: enclosure for the operators. As the time actually spent in making the adjustments during the shift was small, the daily noise exposure index would be at or below the required 1.0 if 1½ to 2 hours exposure at 100 dBA were balanced with the remainder of the shift in a protected area below 85-dBA levels.

Since this reduction would require only a minimum shelter for 15 dBA attenuation, a simple construction could be used consisting of ½-inch plywood, two sides on a 2 x 4 inch framing, with one door and a viewing window plus lighting. Due to paper mill conditions, the enclosure was heated and air conditioned for worker comfort. Record keeping could be done inside the enclosure.

Figure 5.9.2 shows the attenuation obtained inside the control room; the noise level was reduced from 97 dBA outside (Figure 5.9.1) to 77 dBA inside, well within compliance levels. Reducing the noise levels further would require an enclosure with improved transmission loss construction (such as concrete block).

Control Approach Chosen

A sketch was made following the lagging design parameters discussed above, requiring 3-inch Fiberglas grade TIW, plus two top layers of 1/64-inch lead sheeting, all held to the surface by "sticklips" glued to the surface (normal method of acoustic application in buildings). Each layer of the lead was waterproof taped to protect the absorbing layer from water cleanup. Two layers were used to get best waterproofing.

Shafts, bearing boxes, and the drive motor were not lagged because vibration readings did not justify the action, as noted above.

The sketch shown in Figure 5.9.3 was used by an acoustic contractor for estimating and installation purposes. Cost was \$600 per Jordan, averaged over all six. Total enclosure cost would have been at least \$4,000 for each Jordan, based on a quotation from an enclosure supplier; thus lagging achieved a net savings of \$3,400 per machine.

Noise Reduction Achieved

For a single Jordan paper-pulp refiner, the noise level at the operator station was reduced by 11 dBA, from 97 dBA to 86 dBA. With all eight Jordan refineries similarly lagged and running at normal production, the aisle noise level ranged from 88 to 91 dBA. Even for unusually high production in the fastest mode, these same levels ranged from 92 to 94 dBA. This lagging produced acceptable daily noise exposures of less than unity.

Pitfalls

Paper mill conditions should be studied carefully because the noise absorbing materials cannot be exposed to the wet conditions of a paper mill. Maintenance methods were reviewed before design, leading to a separation of the lagging at the front flange so that it could be removed for maintenance.

Cover plates requiring occasional removal were not lagged, as noted in Figure 5.9.3. A disadvantage is the lack of smoothness of this surface--it makes lagging look like upholstering!

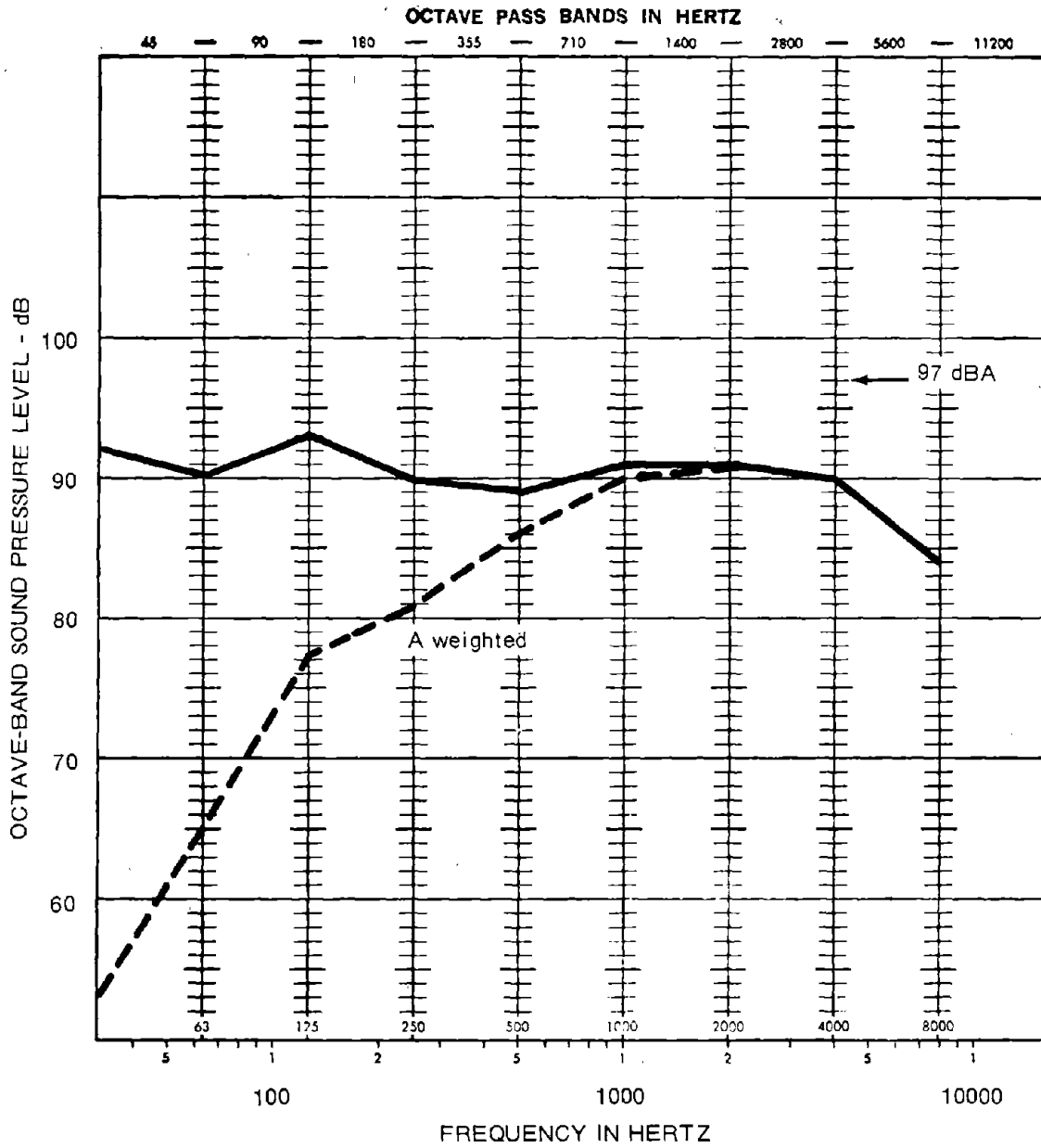

FIGURE 5.9.1 - Noise levels 1 meter from Jordan refiner

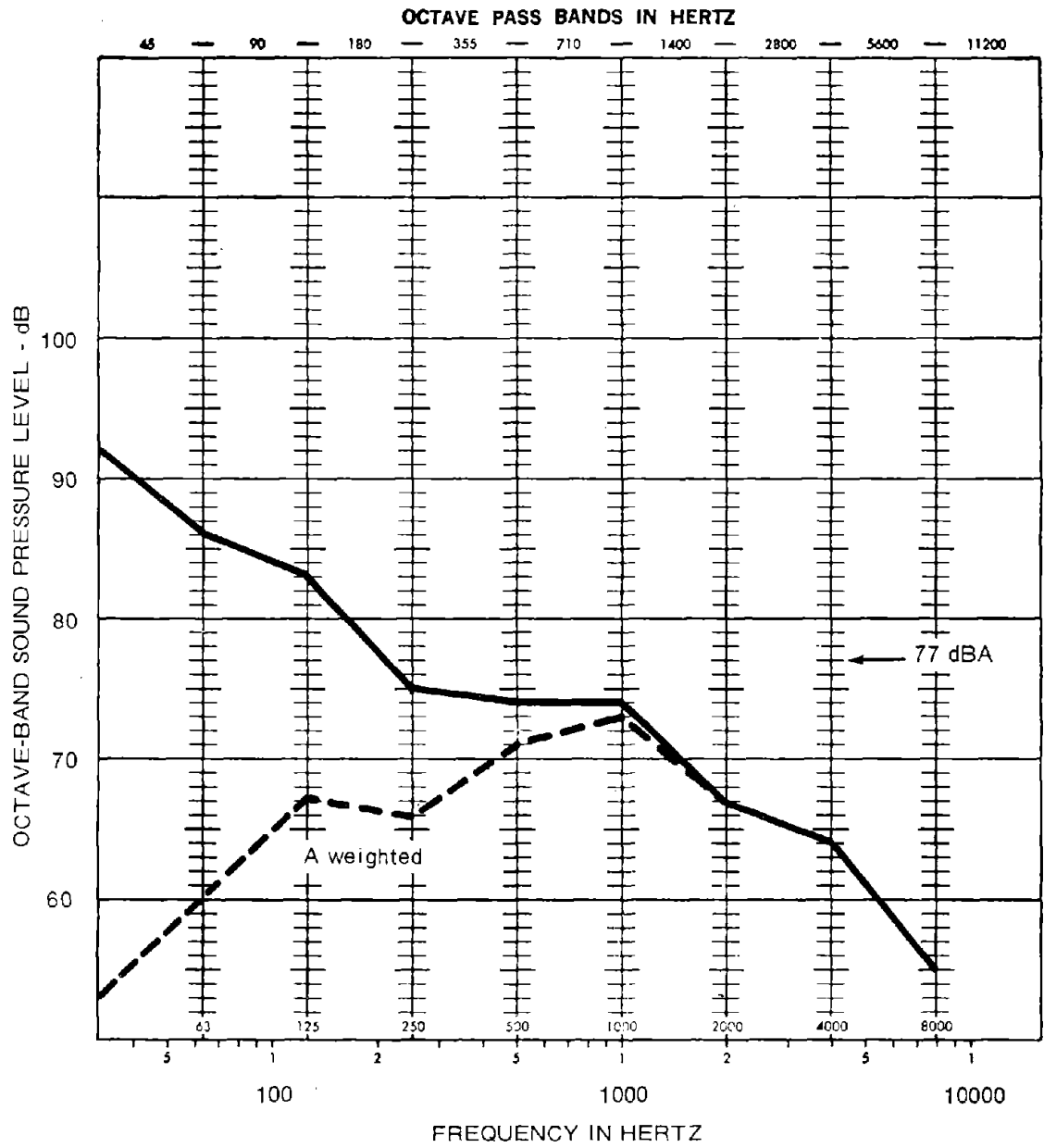
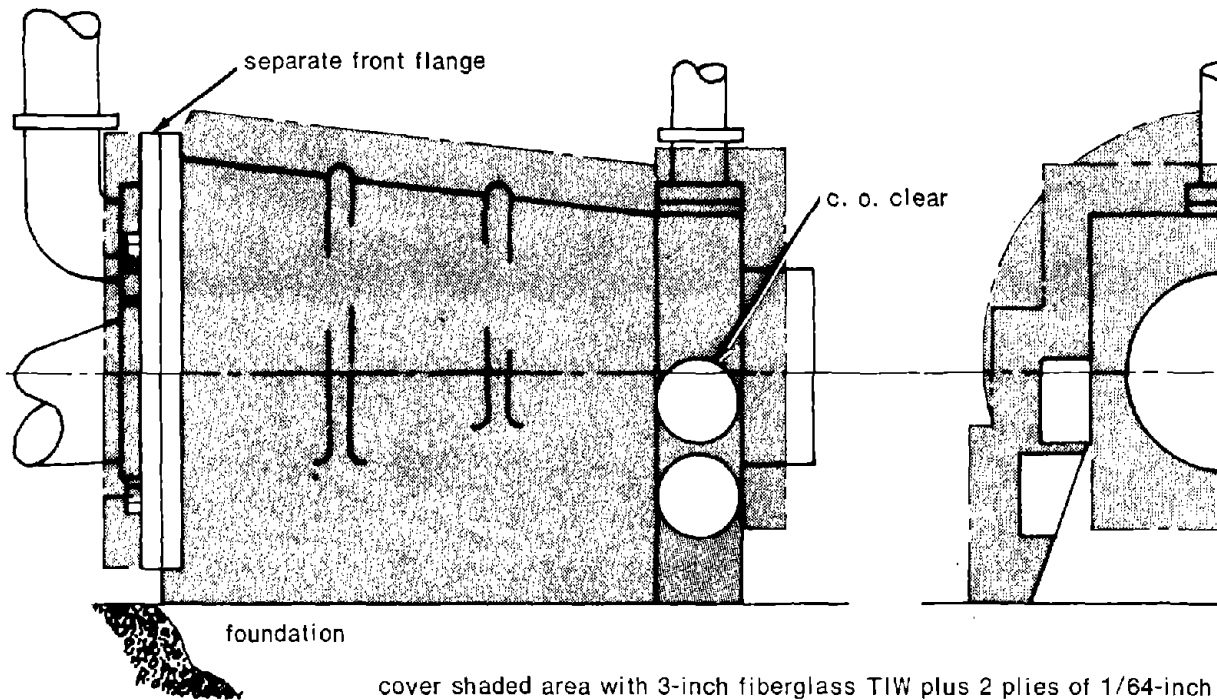

FIGURE 5.9.2 - Noise levels inside enclosure of control room for Jordans



cover shaded area with 3-inch fiberglass TIW plus 2 plies of 1/64-inch sheet lead. Tape for water resistant joint. Fasten stik-klips and caps.

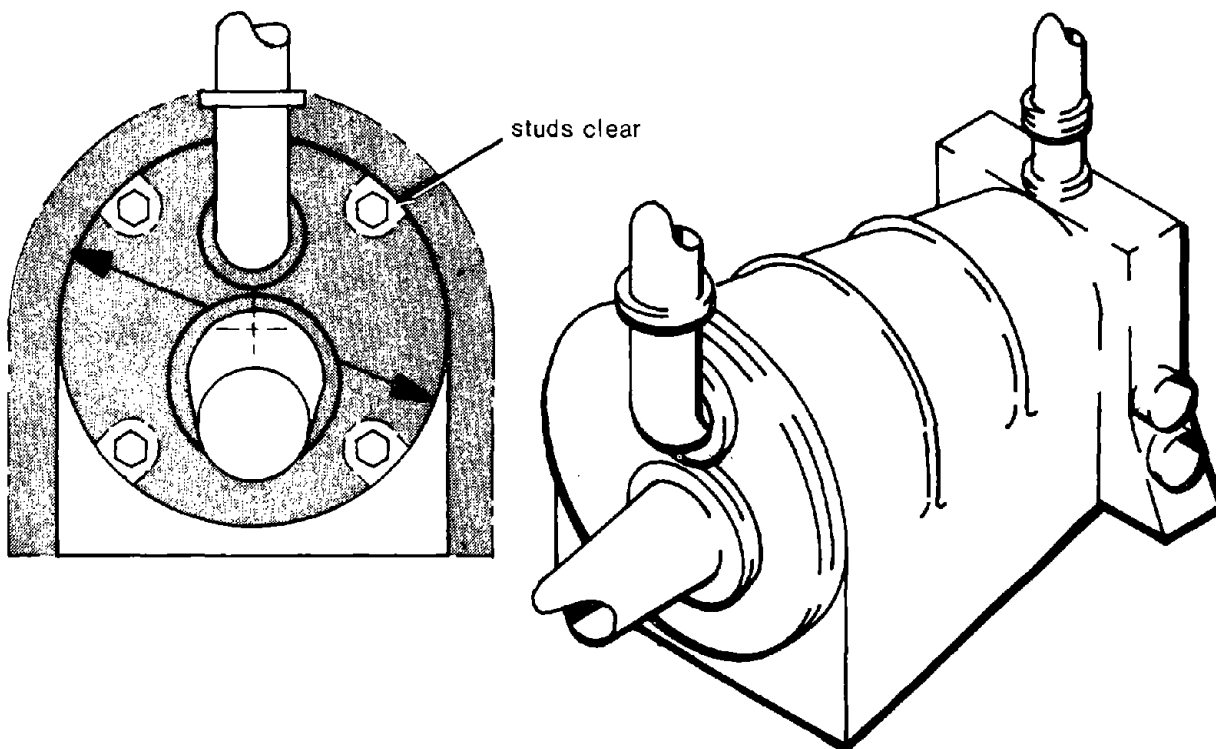

FIGURE 5.9.3 - Noise reduction lagging for Jordan shell

CASE HISTORY #10 - FOLDING CARTON PACKING STATIONS,
AIR HAMMER NOISE SOURCE

Description of the Problem

In the manufacture of folding cartons, the individual cartons are cut, and the cut sheets are stacked by the cutting press on a pallet. To deliver the multiple sheets from the press, the cartons are held together with a nick or uncut portion. When stacked, the individual cartons are separated by stripping with an air-driven chisel which breaks the nicks and frees an entire stack. When no additional operations are needed, these stacks are packed in cases for shipment.

Air hammers/chisels produce noise that has not yet been eliminated by equipment manufacturers. Currently available air hammer mufflers do not reduce the noise to an acceptable level. The air hammer operator therefore must wear ear protection. The problem in this case was to protect other workers (packers) from the air hammer noise. A typical production air hammer stripping and packing set-up is shown in Figure 5.10.1.

The production sequence for this operation is for the stripper to air hammer a stack of cartons (precounted by the cutting press) and place them on the conveyor at Point C. The packer, at the end of the conveyor E, prepares the case, packs the stacks of cartons, seals, labels, and stacks the finished pack on a delivery skid. Two packers are required to handle the output from one stripper. The stripper is actually using the air hammer about 50% of his time, with the balance of the time used in stacking or preparing the load. Thus he can get some relief from continuous use of his ear muffs by hanging them around his neck while not actually using the hammer. It is easier to sell the use of ear muffs when needed if the operator can get some relief when muffs are not needed.

Measurements

As the specific wavelength requirement is minimum in this problem; no octave band readings were made; all data were based on A and C scale readings from an acceptable Type 2 sound level meter.

Control Approach Chosen

It was decided to protect the packers from the air hammer stripping noise by using a barrier wall. The previous chapters described the theory of barrier walls in detail, but a convenient rule of thumb is that useful protection is afforded by the barrier wall beyond 30 degrees into the acoustical shadow. Note that in Figure

5.10.1, the packers behind a wall 10-feet long and 6-feet high are within this protected zone in both top view and side view of the operation.

The barrier wall need be no better acoustically than the attenuation afforded around the sides and top of the wall. The wall was therefore fabricated using a 2 x 4-inch frame faced on both sides by ½-inch plywood for a simple sturdy barrier wall.

If there had been any reason to reduce noise reflections from the noise source side, this side could have been faced with sound absorbing acoustic materials, but it was not needed in this case.

We used the rule of thumb of aiming for the packer to be well within the 30 degree line from the acoustic shadow line. Other means of estimating the attenuation of barrier walls are covered by Beranek in Noise and Vibration Control, page 178, and illustrated in Figure 5.10.2. The attenuation calculated for this barrier wall ranges from 10 to 15 dB, depending on the wavelength. This agreed with the measured attenuation of 7 to 12 dB and the noise reduction from the 92 to 97 dBA range to about the 85 dBA average measured at the packer's ear level.

Cost

The barrier costs were:

½-inch plywood, 2 sides, 5 sheets, 4 x 8	160 sq ft	\$30.00
2 x 4 inch framing	60 ft	10.00
In-plant labor		<u>60.00</u>
Approximate total		\$100.00

Pitfalls

In this installation, we were fortunate not to have low ceilings, which would have established a serious sound reflection problem and defeated the barrier wall. Barrier walls will not give good results in a highly reverberant, low-ceilinged room. If there had been a low ceiling, useful level reduction would still have been possible by adding sound absorbing material at the reflecting portion on the ceiling (about 12 feet over the barrier wall and the noise source). The amount of attenuation gained is easily estimated by using the ratio of absorption of new material to that of the existing ceiling. Ceiling reflection is a major pitfall of the use of barrier walls indoors. The design of the wall alone is based on free field conditions.

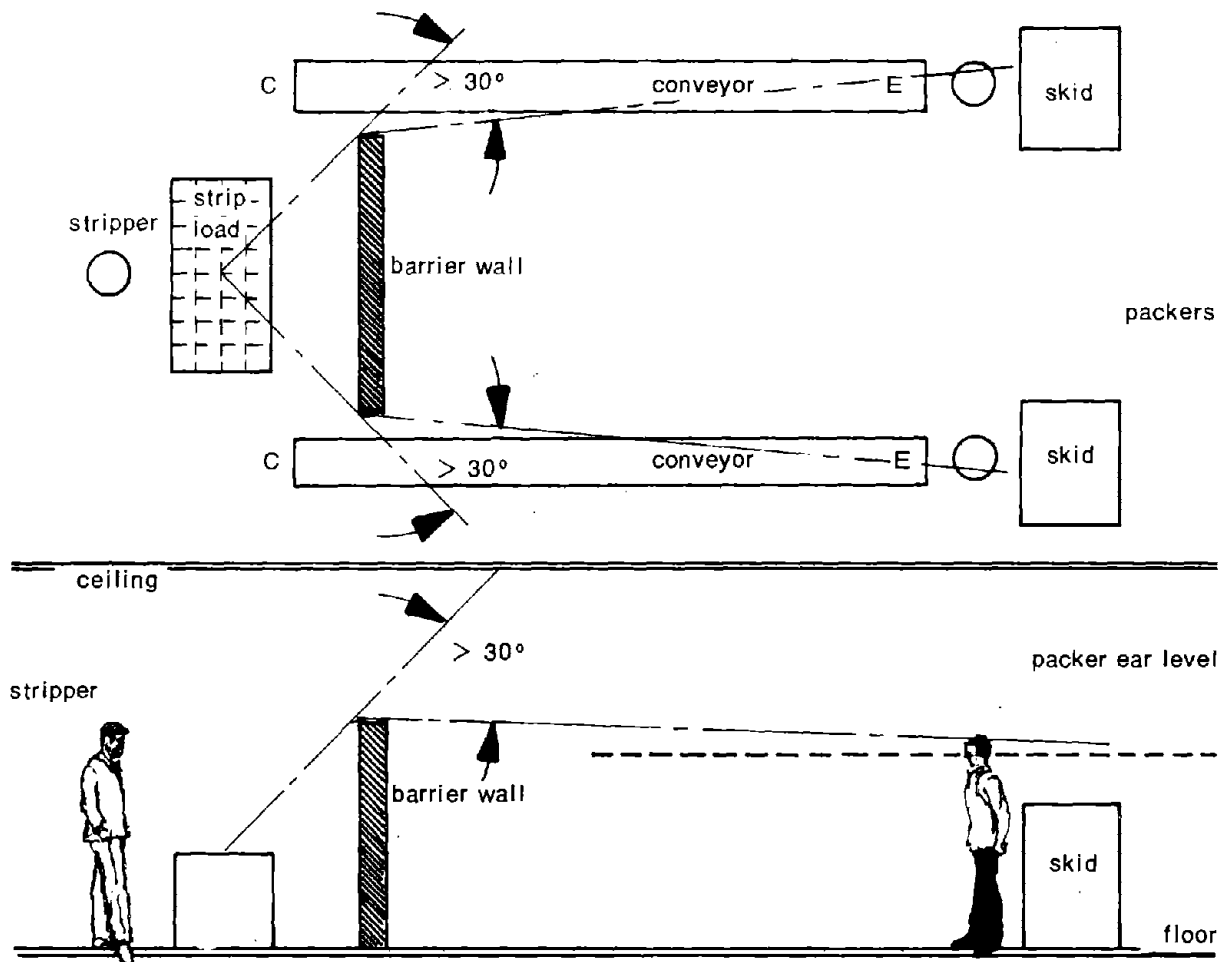
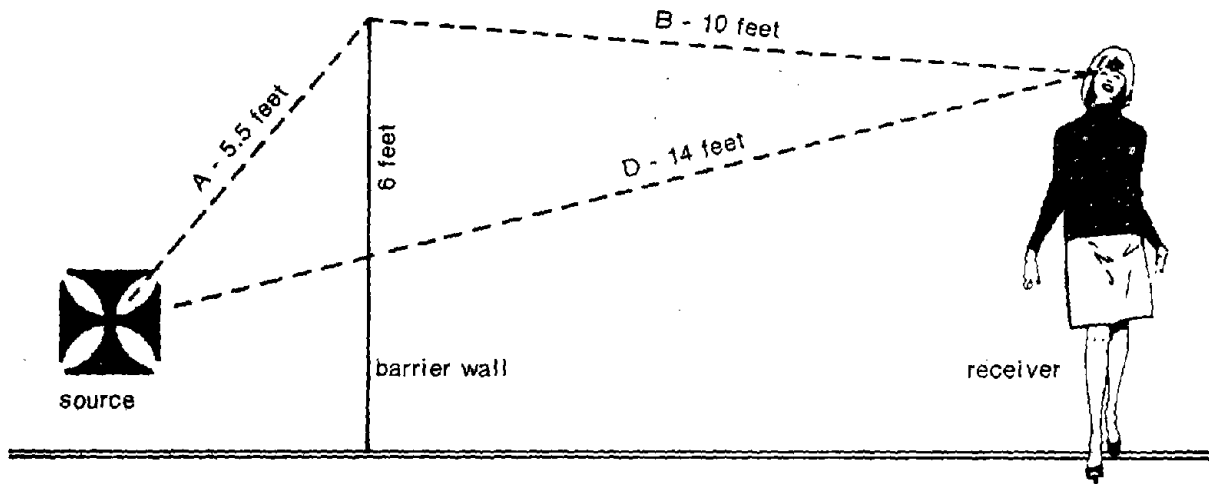

FIGURE 5.10.1 - Air hammer stripper and packer line



$$N = \frac{2}{\lambda} (A + B - D)$$

$$N = \frac{2}{\lambda} (5.5 + 10 - 14)$$

$$N = \frac{3}{\lambda}$$

	250 Hz	500 Hz	1000 Hz	2000 Hz
λ	4.8	2.4	1.2	0.6
N	0.625	1.25	2.5	5
dB	10	11	13	15

Source: Beranek, *Noise and Vibration Control*, page 178.

FIGURE 5.10.2 - Barrier wall theory

CASE HISTORY #11 - IN-LINE GRAVURE PRINTING AND CUTTING PRESS FOLDING CARTONS

Description of the Problem

In the manufacture of folding cartons, one method is to print the cartons in a web, using multiple gravure color stations and feeding the printed web into a reciprocation cutting press.

The reciprocation cutting press, using a rule die, cuts the cartons and delivers cut cartons to a delivery belt. The rotary printing operation was not noisy, but the cutting press noise from the cutting head was in the range of 93 to 95 dBA at the normal operator position. The take-off operators were far enough from the noise source, so noise at their station was below 90 dBA.

Control Approach Chosen

Figure 5.11.1 shows the operator location, control station, cutting head, and carton delivery. To reduce the noise of the cutter head at the operator position, we decided on a barrier wall. As access to the unit for job changes and maintenance was important, the barrier wall was specified to be the lead-filled vinyl sound stopper curtain material available on a made-to-order basis and designed to be portable.

The curtain unit ordered was 7 feet high and 8 feet long with a viewing port 10 x 20 inches, since the attenuation required for OSHA compliance was only about 5 dBA minimum.

Noise Reduction Achieved

The operator location noise at the control console was reduced from the 93-95 dB range to an 86-87 range. The operator performed inspection and adjustment at the cutter head for a few hours daily, as required, but was still within the time exposure limits.

Total cost, using a lead-filled vinyl curtain at about \$4/ft², was about \$300, including hanging fasteners, viewing window in curtain, and pipe supports.

Pitfalls

To get any attenuation from barrier walls, the receiver must be located with respect to the noise source so as to be beyond 30 degrees into the acoustical shadow line, as a rule of thumb. Note that in the top view, Figure 5.11.1, the pressman operator is just within this line. In Figure 5.11.2, showing over-the-wall vertical plane limitations of this same rule of thumb, the pressman operator

is well within this limiting area. The curtain met the objective since only a small attenuation of about 5-6 dBA was required and the actual real attenuation was 7-8 dBA. More attenuation would require a larger curtain.

A design pitfall in barrier walls is that if room conditions are too reverberant and the ceiling is too low, the barrier wall is bypassed. Low ceiling reflections can be overcome by adding an absorbent to the reflecting area of the ceiling over the barrier wall.

In Case History #10, a relatively permanent wood construction wall was used. This case required a different treatment because regular access was required to the cutter head between the console and the press. The free standing, easily movable curtain wall provided both protection during operation and easy access to the press for set up.

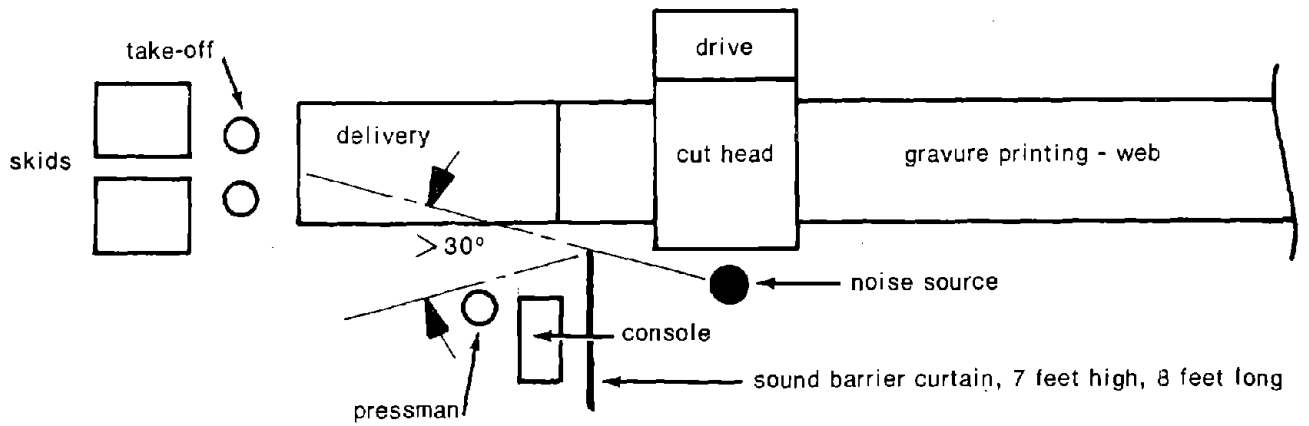

FIGURE 5.11.1 - Top view of in-line gravure-cut press with sound barrier curtain

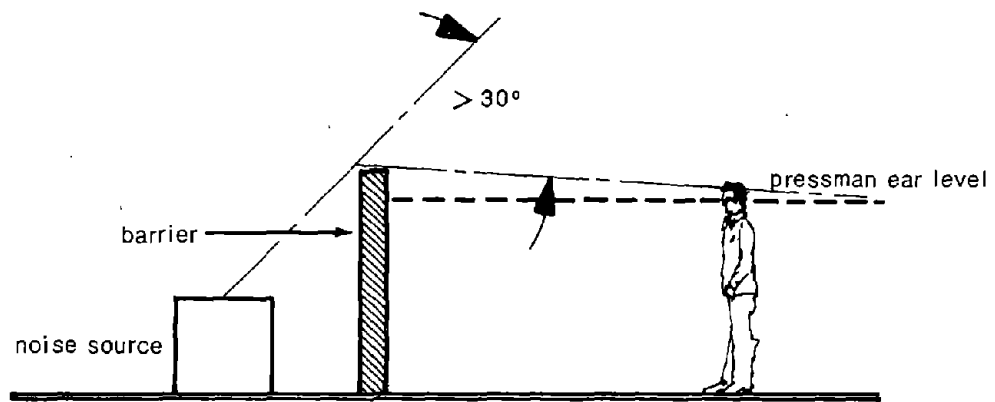

FIGURE 5.11.2 - Side view of in-line gravure-cut press with sound barrier curtain

CASE HISTORY #12 - AIR SCRAP HANDLING DUCTS FOR CORRUGATED CONTAINER INDUSTRY

Description of the Problem

In a corrugated box factory, slit side-trim is removed from the conveyor by air. Trim blower fans with extra heavy blades cut the trim while conveying it via ducts to bins and balers. The 12-inch ducts are suspended from the ceiling about 10 feet from the floor, crossing a 40-foot-long work room en route to the bins and baler room.

Ear level noise levels were 93 dBA.

The trim is carried along in the ducts by the air, which normally moves about 6000 ft/min. The trim often strikes the duct walls (mainly at bends), causing noise. Noise reduction was desired to improve worker communication for operations under ducts and to meet the requirements for minimal OSHA compliance.

Measurement and Analysis

Octave band data were collected because this case required not only a reduction of a few decibels to comply with minimum regulations, but noise reduction for safety reasons, to control speech interference. Octave band data are a truer measure of speech interference noise levels than a single number dBA reading. For the minimum compliance data, the dBA reading would have been adequate.

Control Approach Chosen

The solution chosen was to wrap the problem duct locations with 2 inches of mineral wool building insulation to furnish a resilient and absorbing layer. Over this insulation were placed two impervious layers of heavy tar paper, spirally wrapped with 50% overlap.

Noise Reduction Achieved

Noise was reduced considerably in the problem area: levels changed from 93 dBA to 72 dBA, a reduction of 21 dB. To the ear, the noise could hardly be heard above other noise. The octave band comparison is shown in Figure 5.12.1. Although the standard materials used were very economical, special acoustic absorber pipe coverings with lead-filled vinyl sheeting could also have been used and may have given even more attenuation. This was not needed here.

We do not have detailed costs for this case history. However, since the materials are inexpensive, the major cost must have been labor. The job was probably done for less than \$200.

If less attenuation had been required for OSHA compliance only, the sheet metal ducts could have been damped and transmission loss improved by gluing 1/32-inch sheet lead to the duct outer surface. Comparison with the experience at other installations indicated that a 5-dB attenuation would probably have been attained. (See Case History #8 for other methods.)

Pitfalls

Use the most economical methods to attain the attenuation required. The building insulation plus roofing paper used here is a very economical solution.

Note that a large overlap was used; lack of overlap on any wrapping will cause leaks and reduce attenuation.

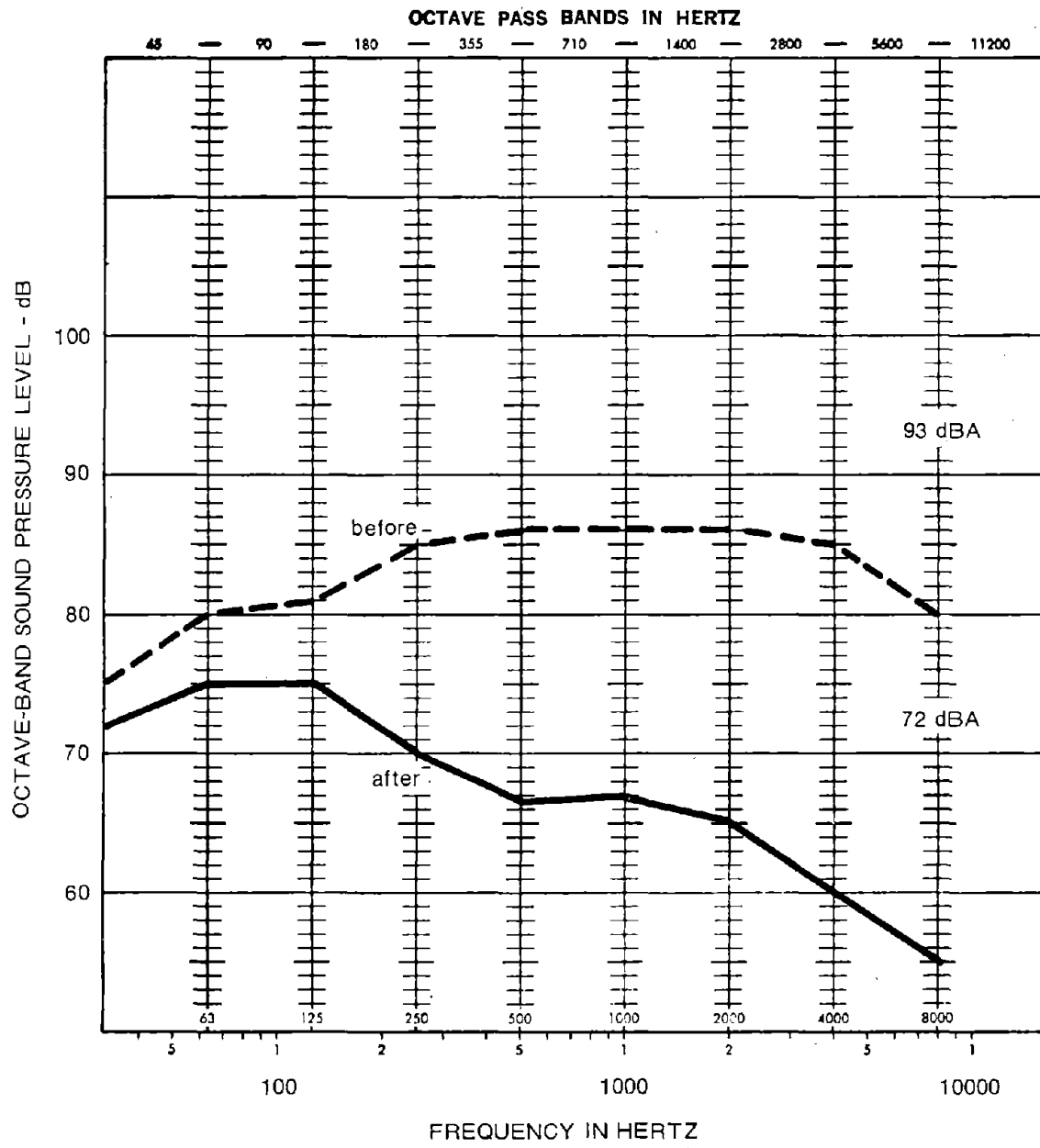

FIGURE 5.12.1 - Noise levels in scrap duct for corrugated box industry, before and after covering

CASE HISTORY #13 - PAPER MACHINE, WET END

Description of the Problem

The major noise sources of the wet end of this paper machine were the couch roll suction air movement, the pumps, and the whipper roll. The whipper roll supplies a beating action on the felt of the paper machine to provide continual web felt cleaning.

Measurement and Analysis

Noise in the aisle at the wet end is shown in the octave band analysis of Figure 5.13.1. The level is 92 to 94 dBA in the operator aisle. Higher readings of more than 100 dBA were obtained close to the couch roll. See Figure 5.13.2 for a sketch of the area.

Paper machine manufacturers have developed a quieter couch roll in which the suction holes in the drum are in a staggered rather than a regular pattern. However, the replacement cost of a couch roll is high, and it will probably be used only on mill expansion projects or new mill construction.

An alternative method to reduce the operator noise exposure was by constructing a personnel booth to house the operator, plus the operating controls, during most of the operating shift. The wet end paper machine operator spent an hour or less making couch roll adjustments during a typical operating day. If the balance of each day were exposure in the mill operating aisle at 92 to 94 dBA, the resulting exposure would be over the dose limits of unity. However, if the operator spent the 1 hour at 100 dBA (couch roll adjustments), 2 hours on general observations near machine at 92 dBA, and the balance of the shift in areas under 85 dBA, including a personnel booth, his daily noise dose would be:

$$\frac{1 \text{ hour actual}}{2 \text{ hours allowed}} \quad (100 \text{ dBA}) \quad + \quad \frac{2 \text{ hours actual}}{6 \text{ hours allowed}} \quad (92 \text{ dBA}) \quad = \frac{5}{6} \quad = \quad 0.83$$

Since this dose is less than 1.0, it is within normal exposure compliance.

Control Approach Chosen

The recommendation for the wet end of the machine (couch roll and whipper noise exposure) was to provide an operator enclosure with operating controls and instruments, and with viewing windows to observe machine operation.

Calculations indicated that the required 15 dB attenuation could be attained with a simple structure consisting of 2 x 4-inch framing with $\frac{1}{2}$ -inch plywood walls inside and out, plus one solid door and two windows 3 x 5 foot each, double glazed. Ceiling and upper half of walls were covered with acoustic tile to reduce reverberant noise. The room was provided with light, heat, and air conditioning for worker comfort. In-plant construction cost was \$2,500.

Noise Reduction Achieved

Results achieved by the enclosure are shown in Figure 5.13.3. Inside noise level was reduced to 75 dBA from 92 to 94 dBA outside.

Greater attenuation can be obtained by purchasing special acoustic shelters or by using more elaborate (from acoustic standpoint) construction such as concrete block walls, double windows, or interior sound absorption.

Pitfalls

Most of the difficulties to be avoided are non-acoustical. It is essential that the operator has no interference with visual monitoring of machine operation. This consideration fixes the booth location and window placement.

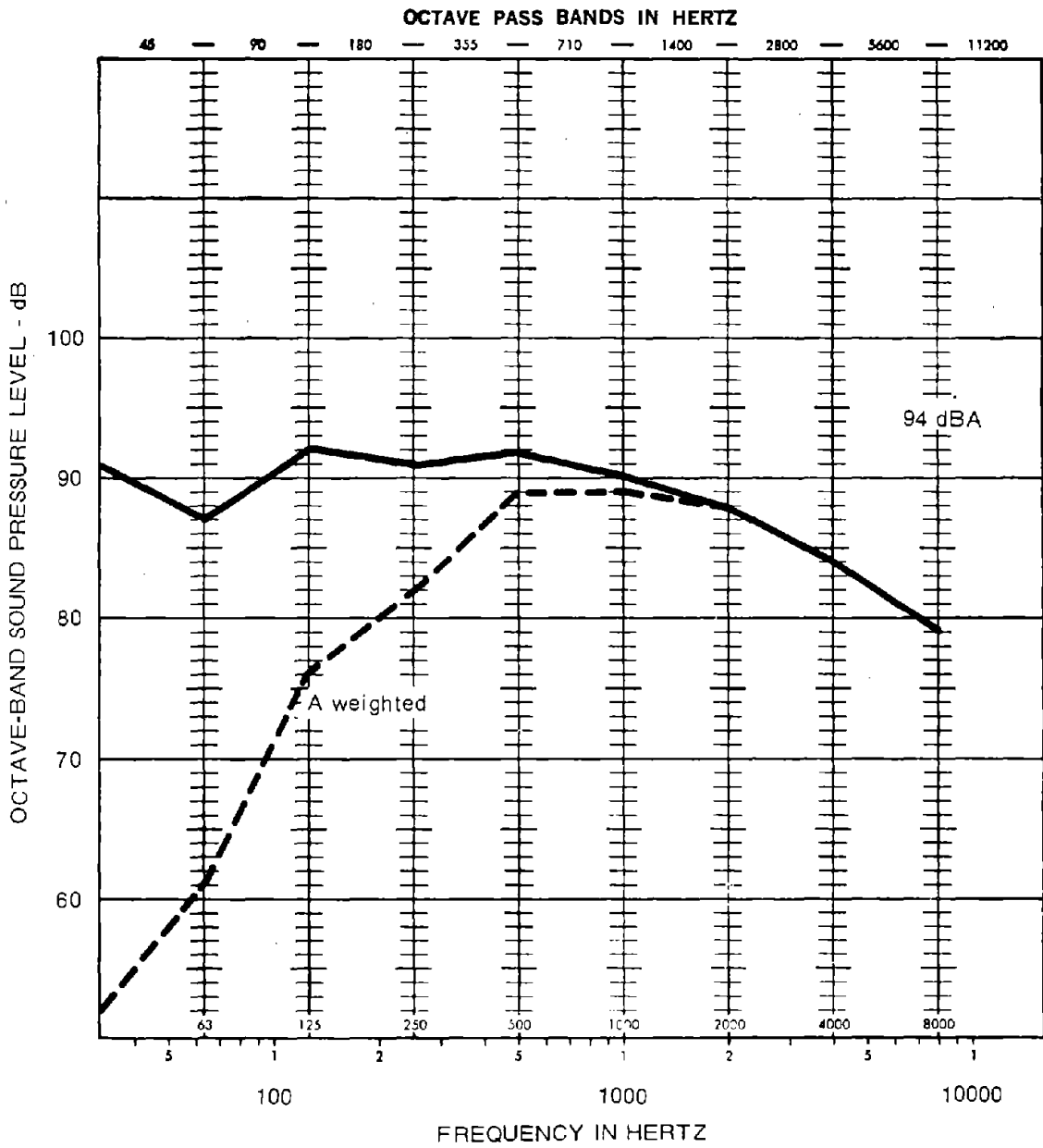

FIGURE 5.13.1 - Noise levels at wet end aisle of paper machine

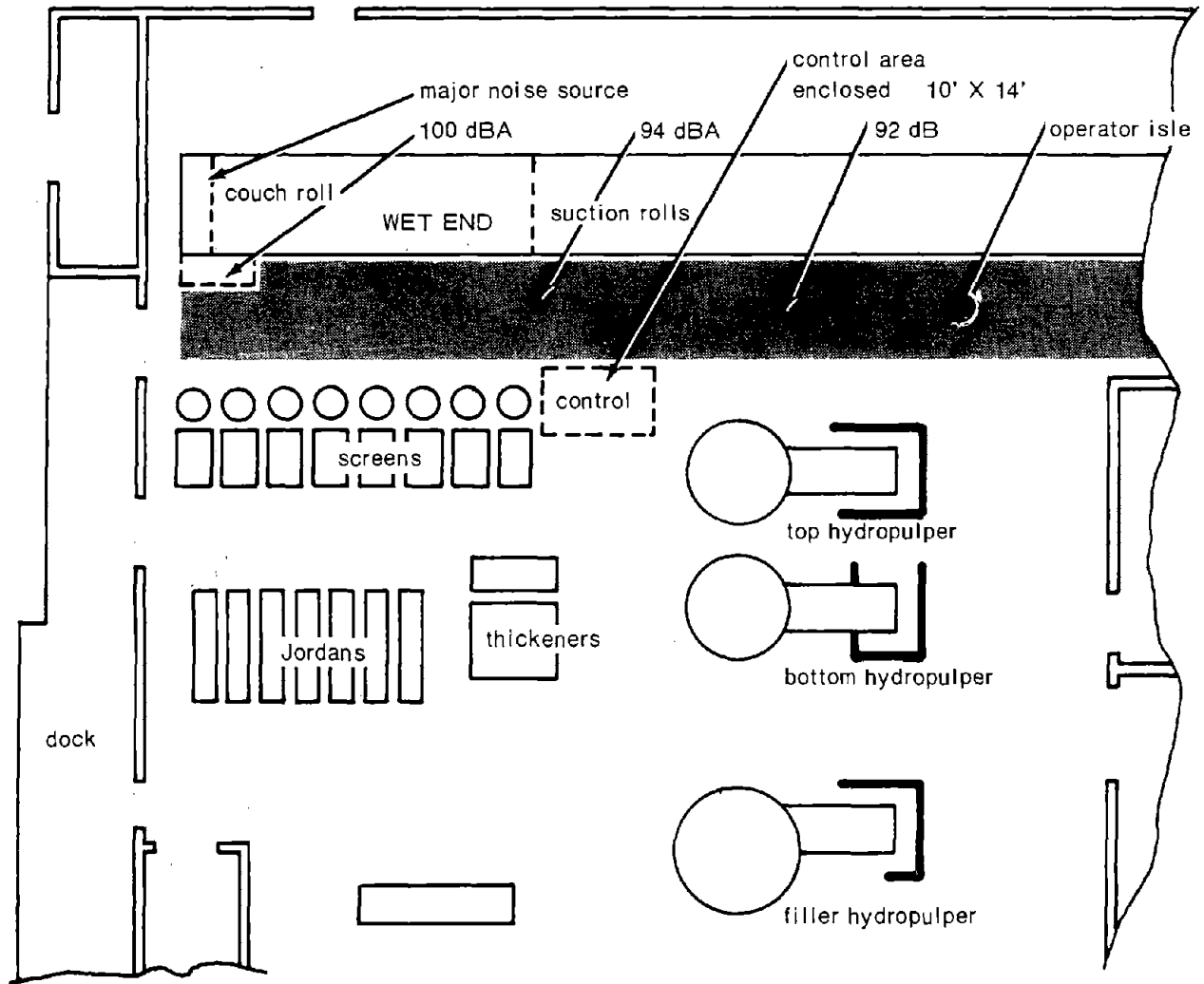

FIGURE 5.13.2 - Paper mill - wet end

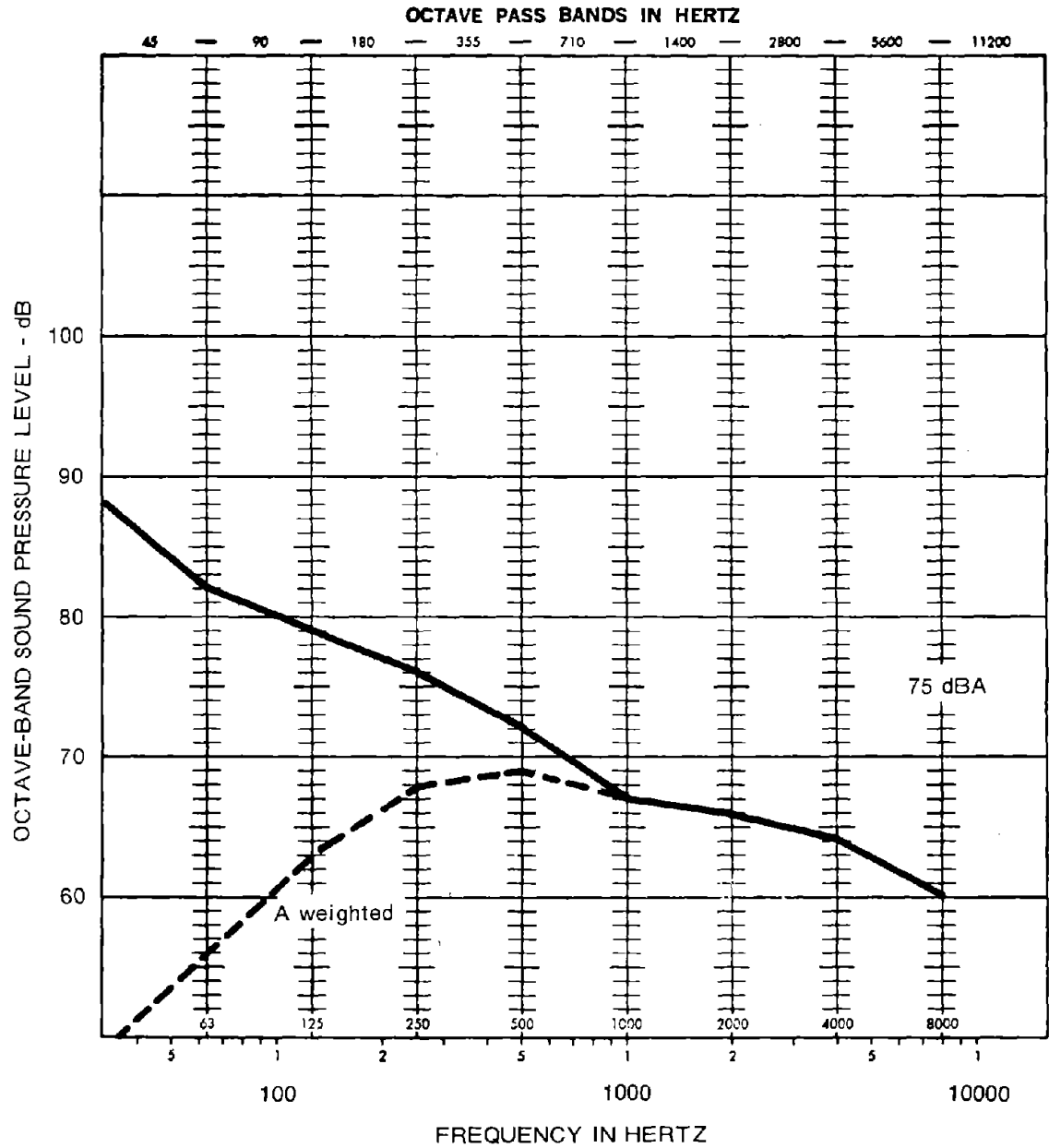

FIGURE 5.13.3 - Noise levels inside control booth at wet end of paper machine

CASE HISTORY #14 - PUNCH PRESS NOISE

Description of the Problem

Punch presses in use in this shop were Summit, Bliss Diamond, and Benchmaster. Within the room were four large presses and four small punches. One of the Summit presses was chosen as representative of the large press group, and the Benchmaster was chosen as representative of the small press group. The general room layout is shown in Figure 5.14.1.

Measurements and Analysis

Octave band measurements were made of the ambient noise levels when all the presses and the nearby furnaces were shut down. Readings were taken near the central supervisor's desk. The overall A-weighted level was a very low 58 dBA, as shown in Figure 5.14.2. This indicated that there were no other serious noise sources. Also noted was the difference in noise level with and without the furnaces. Figure 5.14.3 shows that, with the furnace on, the level increased to 69 dBA, still quite low for most industrial noise levels. Thus, the furnace was also eliminated as an irritant noise source.

Figure 5.14.4 is an octave band analysis taken from the center desk with two Summit presses, two Bliss punches, and one Benchmaster in operation. The level at the desk is 97 dBA, a definite over-exposure condition.

The Summit punch, Location I in Figure 5.14.1, was chosen as typical of a large press. Operator levels, shown in Figure 5.14.5 and 5.14.6, were 106 dBA during operating cycle and 90 dBA during preparation (punch I off, reaching for a new sheet, etc.). At 106 dBA, the permitted exposure time is 0.87 hr. The octave band analysis showed that major noise contributions to the A-level came from the 1000-Hz and higher bands.

Figure 5.14.6 shows the spectrum of noise from operation with nothing in the die. Although a reduction was noted in the 500-Hz band and a small reduction in the 250-Hz and 1000-Hz bands, the 2000-8000-Hz bands, which were main contributors to A-level noise, remained the same as with the full operation. The 1000-8000-Hz bands that were the chief contributors to the A-level were entirely due to the effect of air exhaust noise from jets for removing parts and pushing them into the collection chute. For these higher frequencies and short wavelengths, barriers are efficient. Close-in diagnostic measurements were made behind the press, but no new noise sources were noted except the directionality of some of the air ejection noise.

The reduction sought was from 105 dBA to 86 dBA, with 90 dBA acceptable. This required reductions of:

13 dB in 500-Hz band
20 dB in 1000-Hz band
26 dB in 2000-Hz band
28 dB in 4000-Hz band
31 dB in 8000-Hz band

For a separate study of a typical small press, the Benchmaster (punch VII) was chosen. The operator's position octave band analysis in Figure 5.14.7 shows somewhat less noise than the large press; it has the same general configuration and air jet noise source. Figure 5.14.8 shows the noise levels with no stock in the press, and Figure 5.14.9, the press in punching operation with no stock and no air ejection. Again data were very similar to those for the larger press.

Control Approaches Considered

Our recommendations were: reduce air noise along path by installing a barrier between noise source and operator; and reduce noise from air ejection at the source. The latter was considered first.

Noise caused by high air velocity can be reduced by decreasing the linear flow velocity by increasing the nozzle opening, for same air mass flow. If the diameter of the nozzle is doubled, in a constant volume velocity system, flow velocity is reduced to one-fourth, and noise level is reduced nearly 30 dB (noise of air jet varies approximately as fifth power of velocity). However, thrust would also be reduced, to one-fourth of original value. For proper ejection, the nozzle must be aimed more accurately and more efficiently toward the target. If the distance from the nozzle to the target were reduced 50%, a 30% velocity reduction would give the same thrust. Experiments must be conducted to determine the maximum thrust required for minimum noise.

A barrier between source and operator can add to the attenuation obtained. The barrier should be box shaped around the die (with far side and bottom missing). This barrier replaces the present guard, and handles both mechanical and acoustical guard functions. Materials suggested include $\frac{1}{4}$ -inch plywood, $\frac{1}{4}$ -inch Plexiglas, and $\frac{1}{2}$ -inch Lexan, made with airtight corner joints. Noise absorbent material, Mylar faced for dirt and oil protection, was added inside the box; it must be kept clean during normal operations.

Control Approaches Chosen

Based on suggested possible methods of nozzle construction, a quiet nozzle cover was made. The design of this nozzle is shown in Figure 5.14.10. Air pressure, controlled by a reducing valve, was reduced to the minimum to do the ejection job. (Low-noise air jets are also available commercially.)

A sketch of the barrier is shown in Figure 5.14.11. To afford visual access, the material chosen for the barrier was $\frac{1}{4}$ -inch Plexiglas. The three-sided barrier was locally designed, aiming to have minimum leakage at bottom of barrier (toward the operator).

For absorption, 1-inch acoustical (fully reticulated) polyurethane, with Mylar film covering for ease of cleaning, was glued to the inside surface, leaving a minimum uncovered portion for operator viewing of punch action.

Accurate costs were not available for this in-plant effort; however, the materials were less than \$100 and labor was estimated at \$250.

Noise Reduction Achieved

After experiments with reduced jet velocity and with the barriers described, the following noise levels were attained:

Large punch press reduced from 106 dBA to 85 dBA.
Small punch press reduced from 99.5 dBA to 82.5 dBA.

Pitfalls

The major pitfall for barriers will be to see that it is used. Also when used, the bottom opening or noise leak toward the operator should be kept at a minimum. Another pitfall to continued efficiency will be allowing the Mylar-covered noise absorbent to become dirt and grease laden; periodic cleaning is needed.

A pitfall associated with air volume reduction is the tendency of operators to increase pressure or remove the nozzle.

Attenuation will depend on the success of air velocity reduction in maintaining the needed thrust for ejection in conjunction with noise reduction of barrier. Unless these experiments were done with operator involvement, they may not accept the alterations.

If a mechanical method could be developed to replace air jet part ejection, this would be the best alternative.

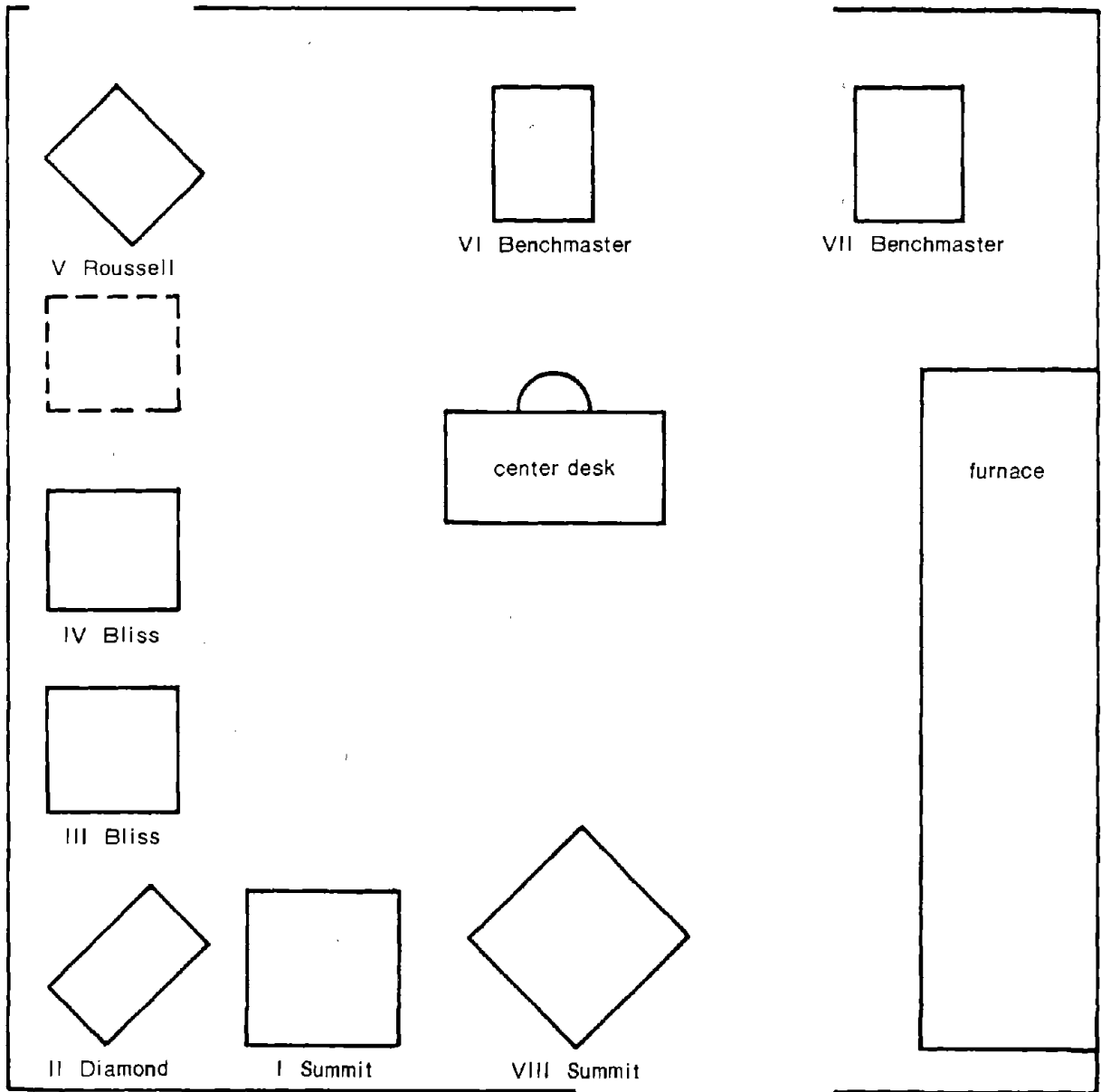

FIGURE 5.14.1 - Layout of punch press room

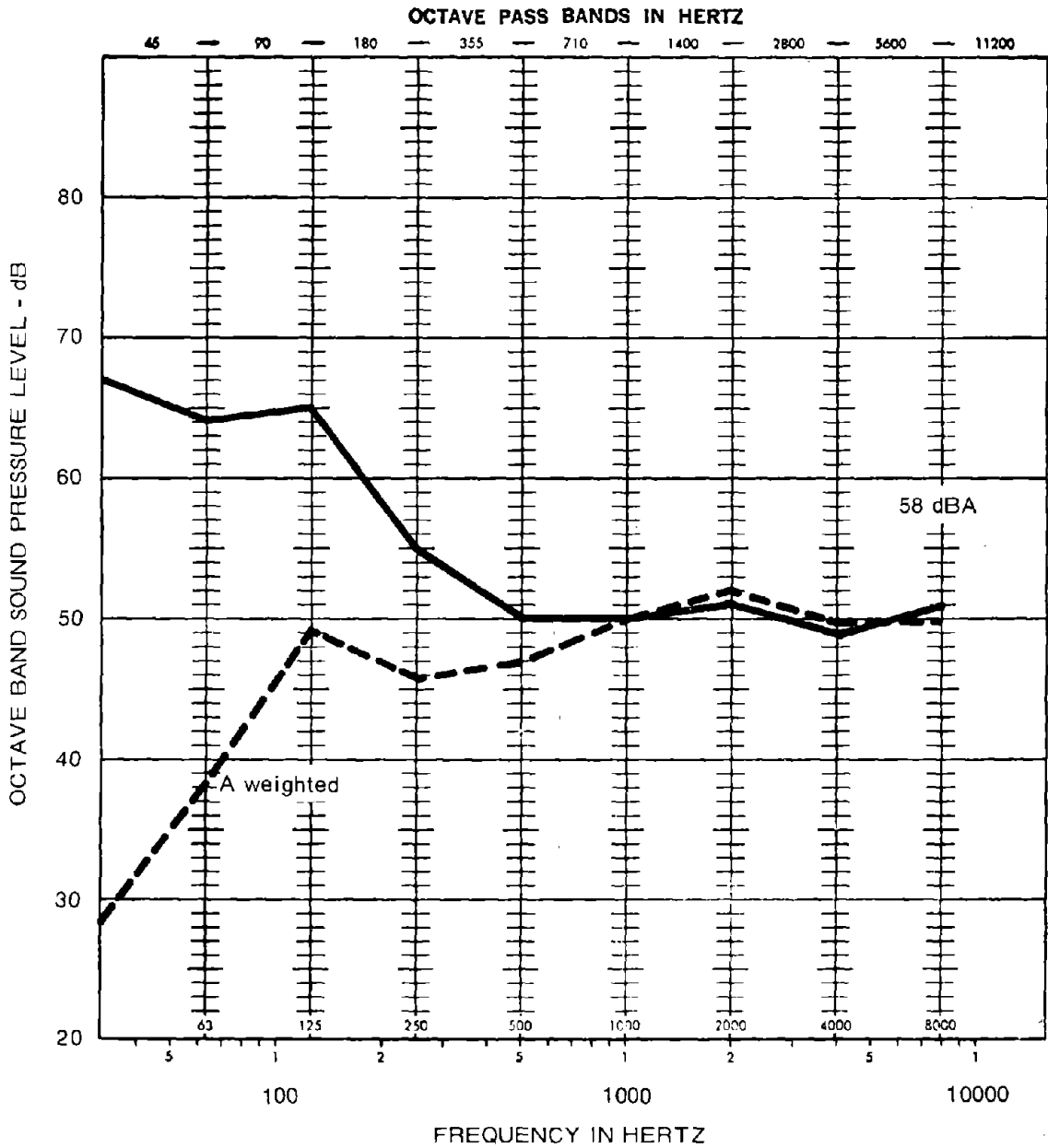

FIGURE 5.14.2 - Ambient noise level with furnace and punch presses off (microphone 1.5 meter above floor, directly above desk chair)

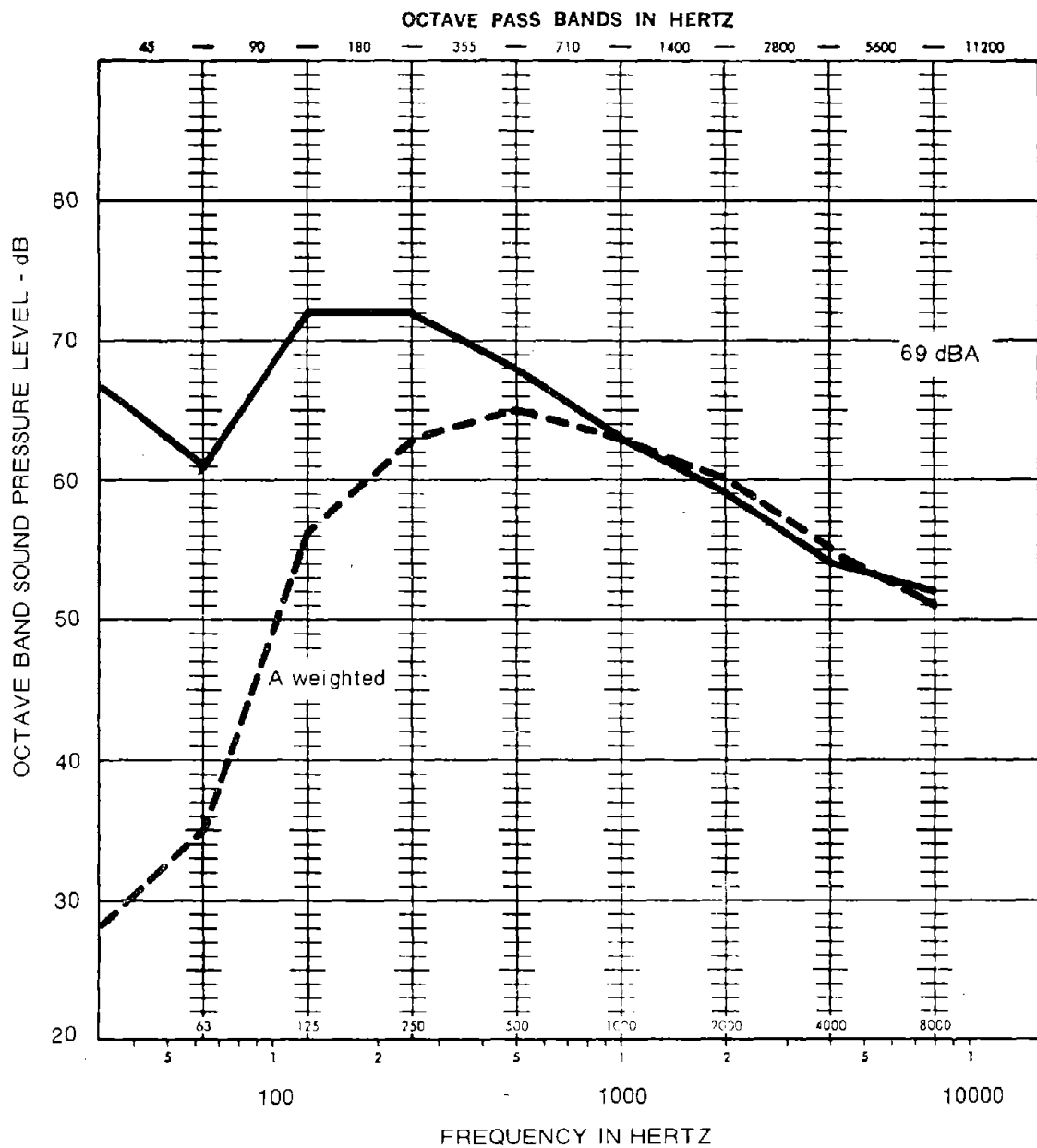

FIGURE 5.14.3 - Ambient noise level with furnace on, punch presses off (microphone 1.5 meter above floor, directly above desk chair)

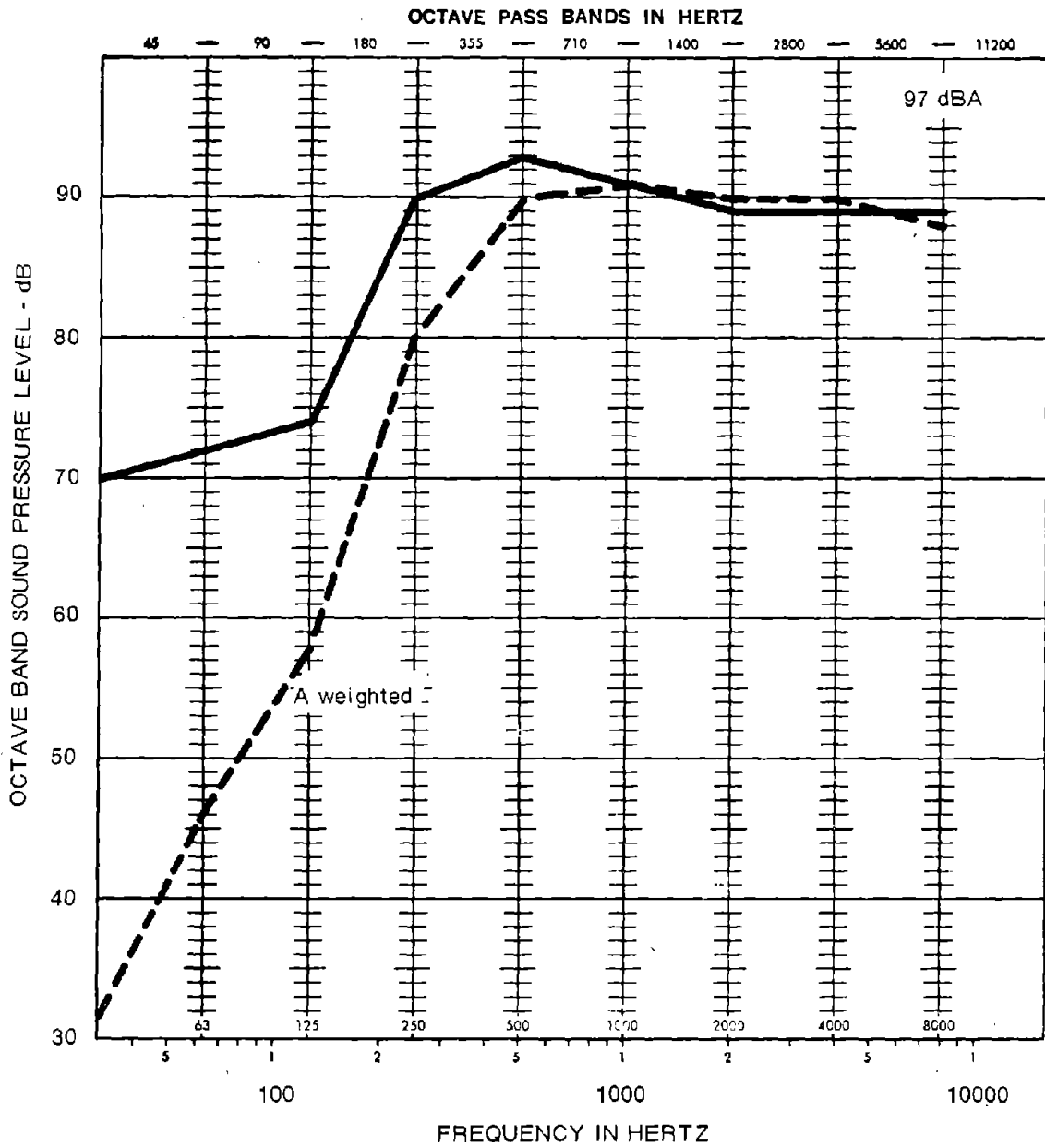

FIGURE 5.14.4 - Ambient noise level with furnace on, two Summit, two Bliss, and one Benchmaster presses in operation (microphone 1.5 meter above floor, directly above desk chair)

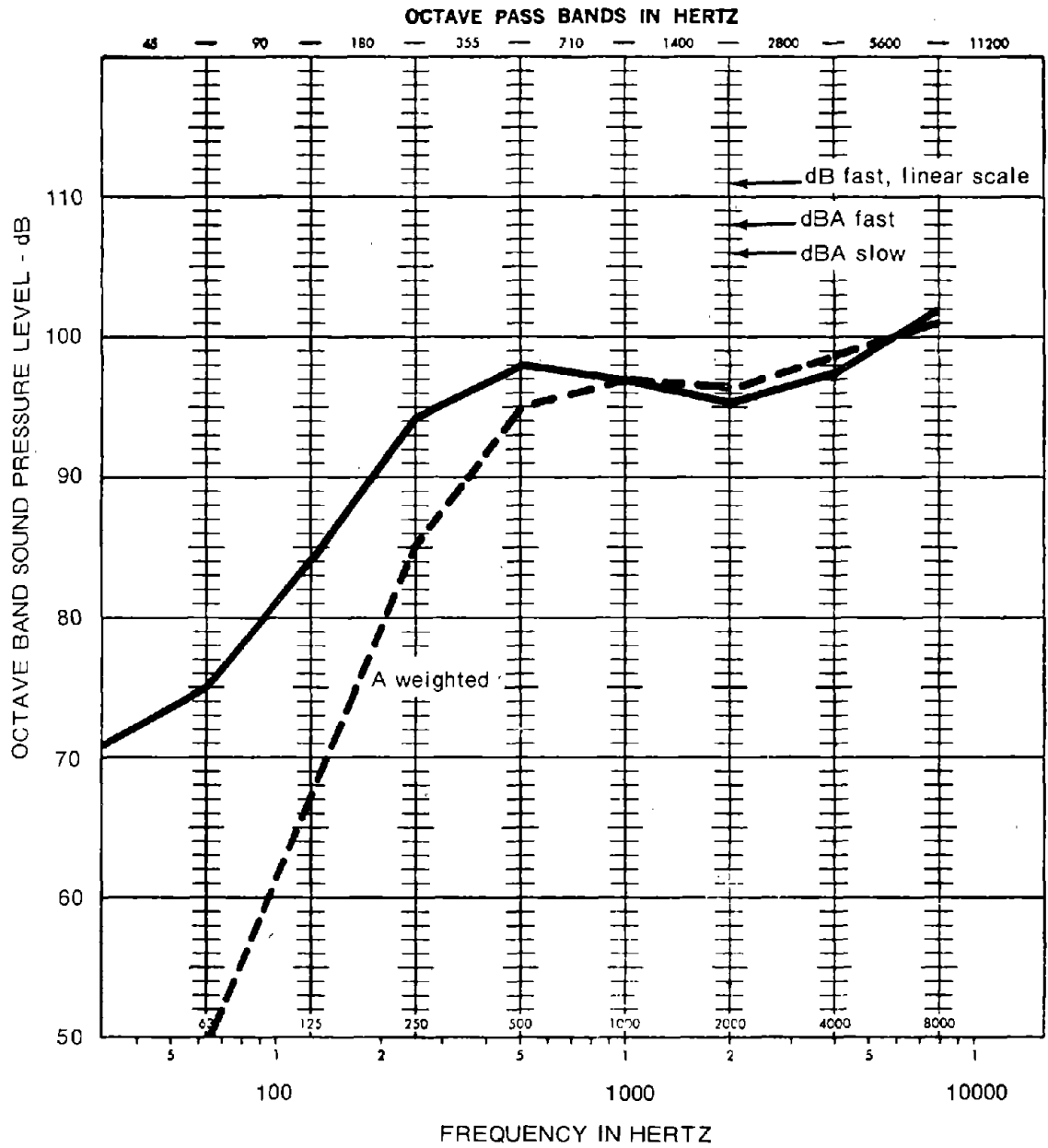

FIGURE 5.14.5 - Operator's exposure at punch 1: stamping stock (air exhaust on, noise level at operator's ear)

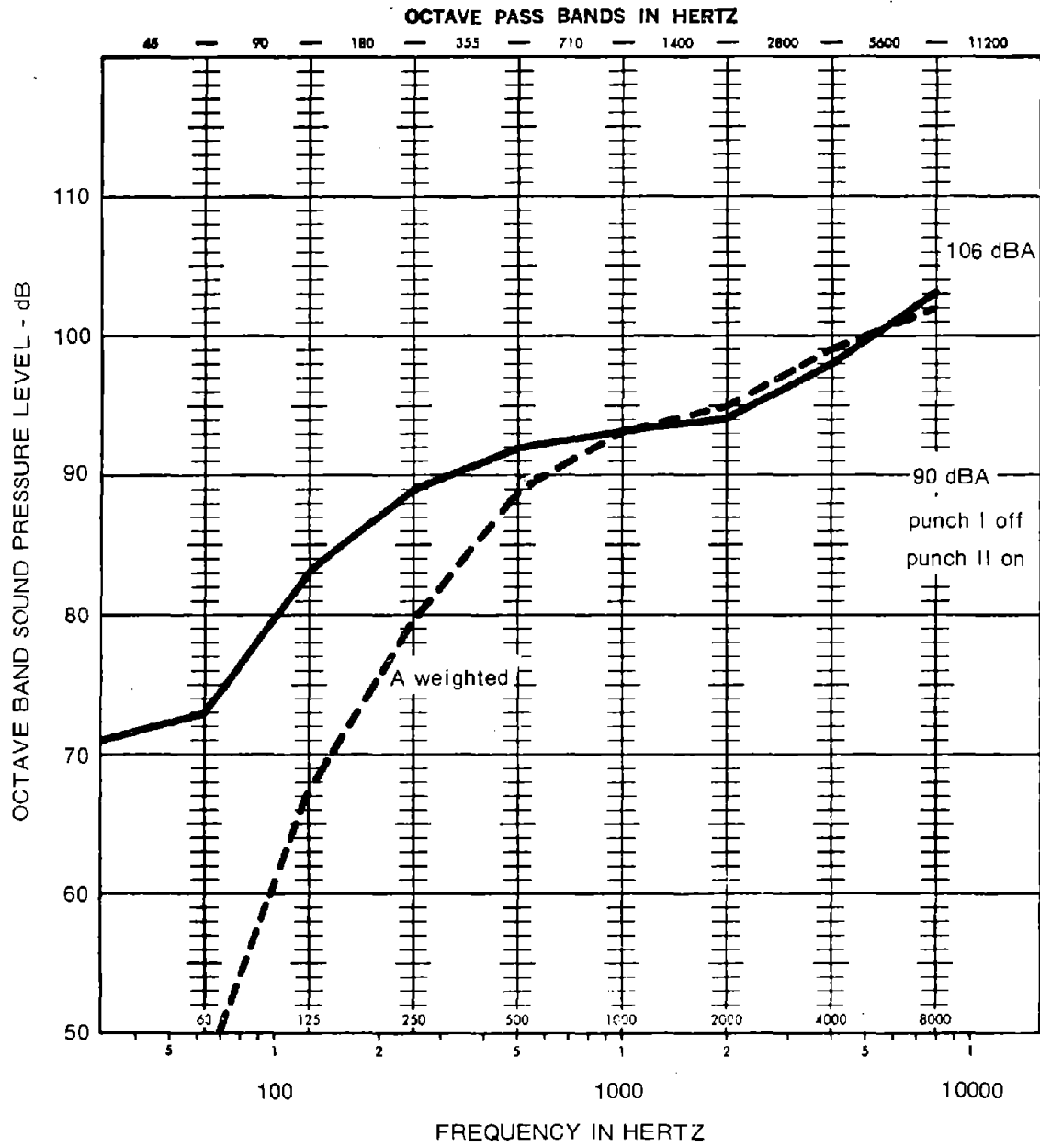

FIGURE 5.14.6 - Operator's exposure at punch I: stamping without stock (air exhaust on, noise level at operator's ear)

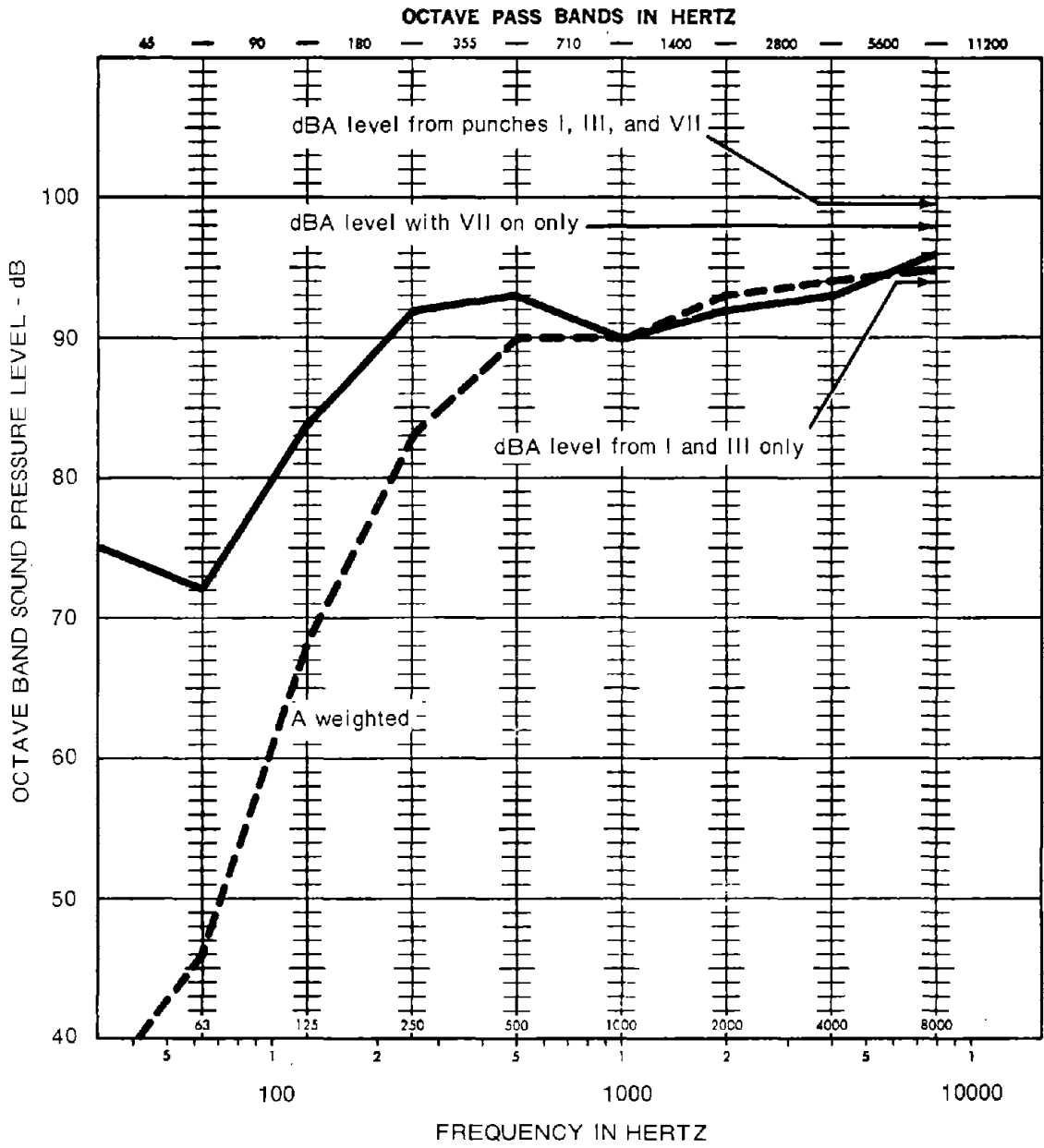

FIGURE 5.14.7 - Operator's exposure at punch VII

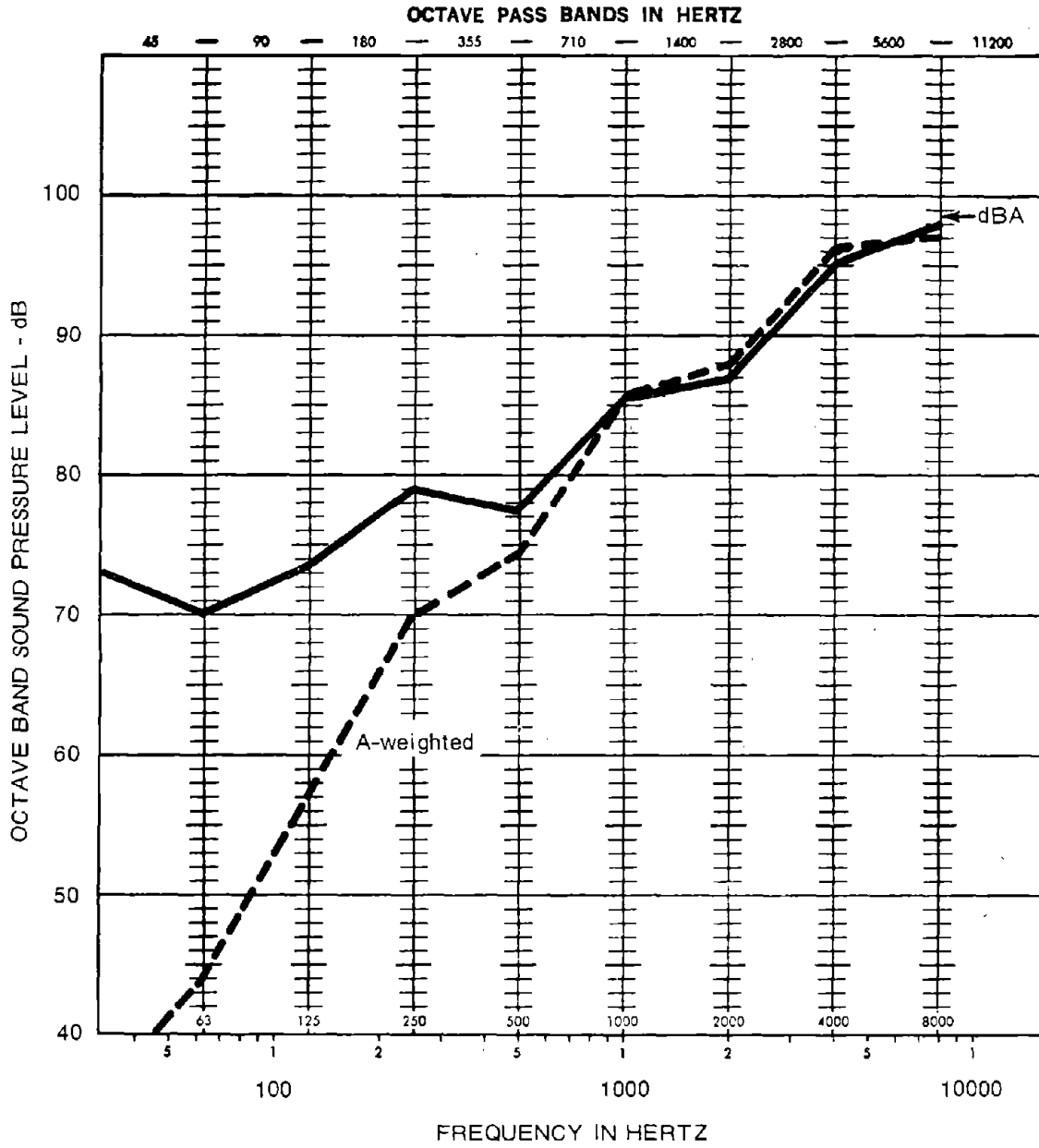

FIGURE 5.14.8 - Operator's exposure at punch VII, operating without work piece

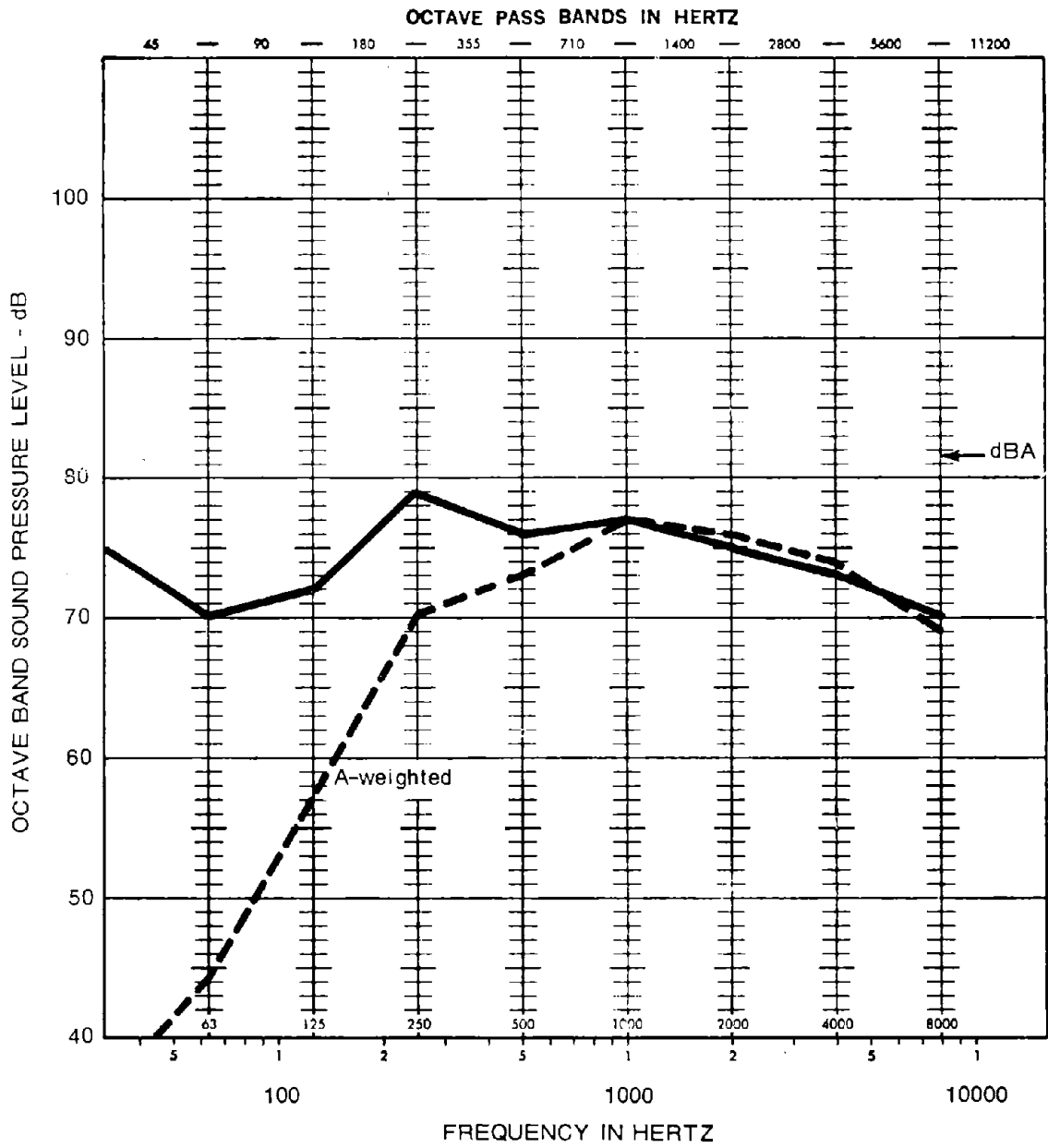

FIGURE 5.14.9 - Operator's exposure at punch VII, operating without stock and without air exhaust

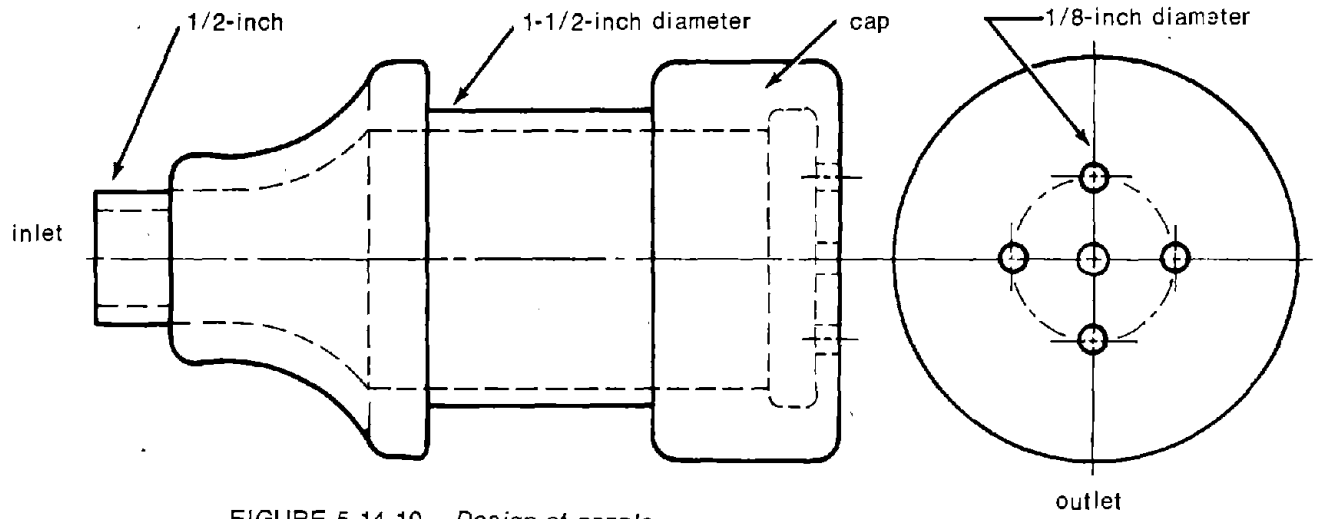

FIGURE 5.14.10 - Design of nozzle

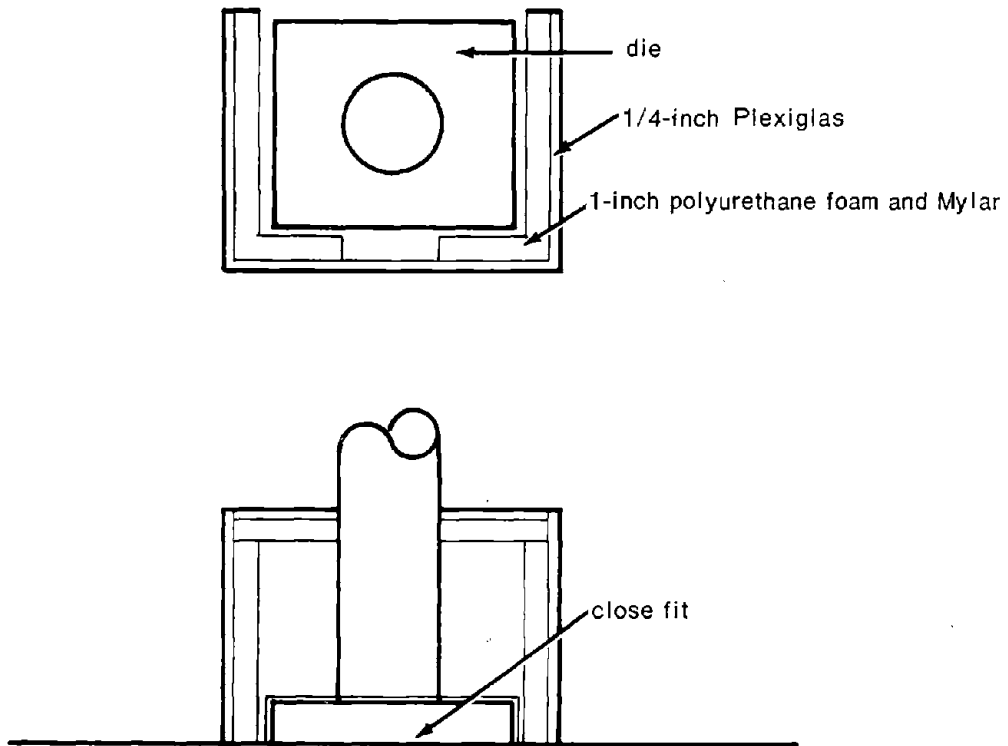

FIGURE 5.14.11 - Sketch of Plexiglas barrier

CASE HISTORY #15 - STRAIGHT AND CUT MACHINES

Description of the Problem

The straight and cut machine straightens heavy gauge wire in an in-feed to cut-off unit set to cut repeat lengths, resulting in noise levels of 92 dBA at operator position.

Measurement and Analysis

Figures 5.15.1 and 5.15.2 are close-in octave band analyses of the diagnostic measurements made in front of the clutch mechanism. In Figure 5.15.1, curve A shows peak cutting levels, and curve B is the slow response of the same cutting levels (wide separation indicates impact noise). Curve C is idling, noncutting machine noise level. The differences indicate dominance of the total spectrum by the cutting noise. In Figure 5.15.2, curve D is the peak response and curve E is the slow response. Curves D and E exceed curves A and B, indicating some directionality of the cutting noise.

Figures 5.15.3 and 5.15.4 are octave band analyses made at the operator position. Most of the operator time is represented by Figure 5.15.3, with the cutting cycle noise level at 92 dBA (idling cycle at only 83 dBA), indicating the dominant noise source of the clutch cutter mechanism is the same form as in the close-in diagnostic measurements. A-weighted levels of these readings show that the required attenuation is 9 dB at 1000 Hz, 7 dB at 2000, and 10 dB at 8000 Hz to reduce noise level at the operator position to 85 dBA.

Control Approaches Chosen

Having determined from management discussions that the machine should not be changed or minor redesign attempted, we recommended attenuation by a barrier wall that would block the sound path from the cutting assembly to the operator.

Barrier materials for obtaining the required attenuation were 1/4-inch plywood, with 1/8- to 1/4-inch Plexiglas for viewing ports where necessary. The barrier wall was extended 26 inches past the extremities of the area encompassed by the cutter and was close to the cutter, about 6 to 8 inches away. The barrier was hung in place, supported by chain from overhead. In addition, an absorbent layer was hooked to the barrier on both sides. To prevent clogging of absorbent, the 1-inch polyurethane foam absorbent was supplied with Mylar facing. See Figure 5.15.5.

Normally, the noise absorbent for barriers is used only on the machine noise source side. In this case, however, noise absorbent

was used on the operator side of the barrier as well to reduce sound field build-up in the space between barriers. With the barrier close to the cutter, the operator would be within the safe sound shadow area--the area beyond a line at least 30 degrees from the edge of the acoustical shadow line.

As the barrier was built in-plant, no actual costs are available but material costs are estimated at about \$100.

Noise Reduction Achieved

The cutting cycle noise levels at the operator location were reduced from 92 dBA to 85 dBA, a 7-dBA reduction. Idle cycle noise level was reduced from 83 dBA to 76 dBA.

Pitfalls

Barriers are easy to remove by the operator for many reasons, real and imaginary, and use must be maintained by supervision. Location of an effective portable barrier must be standardized so that the barrier is not by-passed. Barriers can be by-passed by noise reflections from a low ceiling. If this problem had existed in this case, a section of the ceiling above and about 4 feet on each side of the barrier could have been treated with an absorbing material.

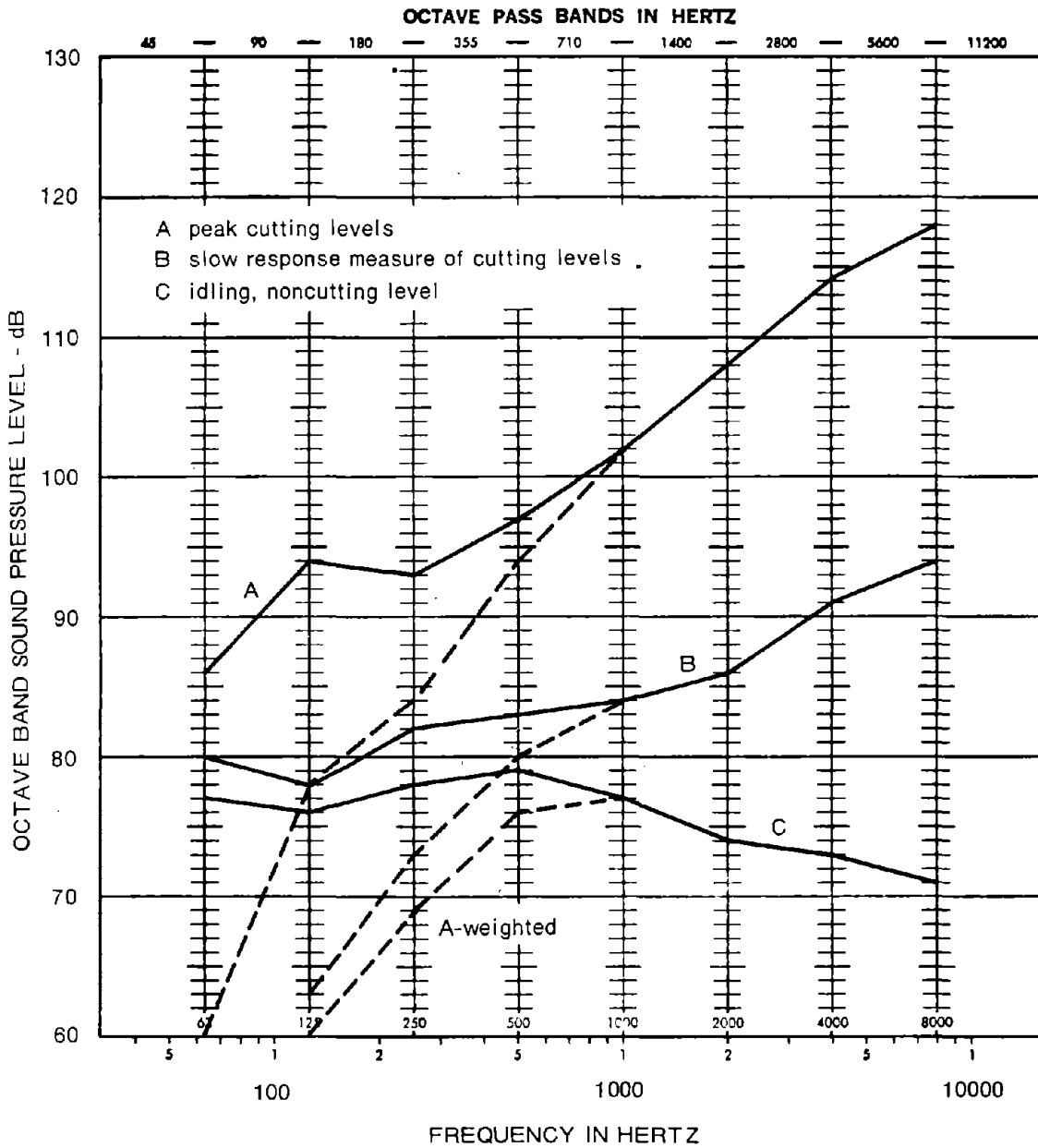

FIGURE 5.15.1 - Straight and cut machine: close-in measure near west side of clutch cutter mechanism (1.2 meter above floor, 0.5 meter from cutter)

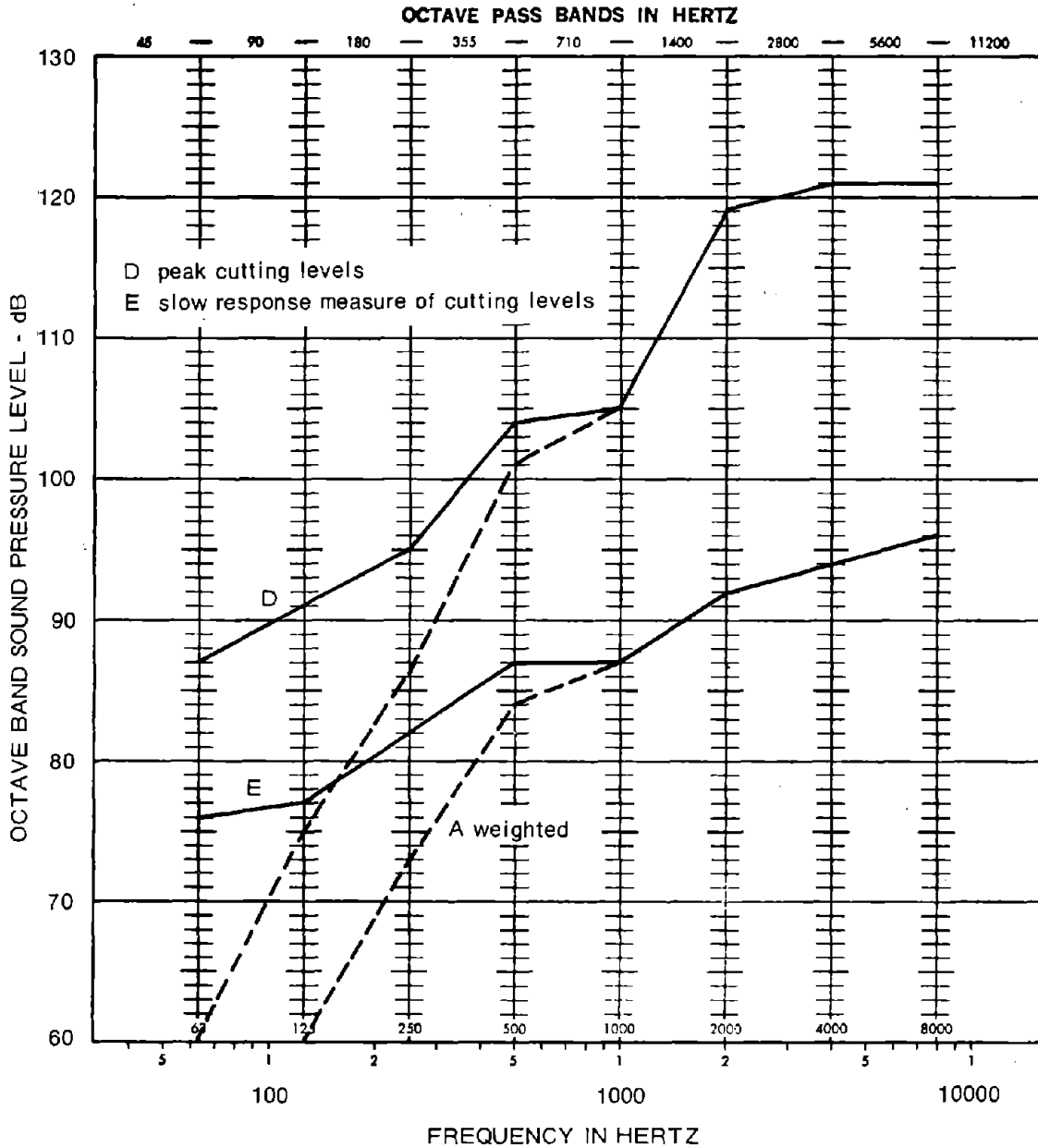

FIGURE 5.15.2 - Straight and cut machine: close-in measure near east side of clutch cutter mechanism (1.2 meter above floor, 0.5 meter from cutter)

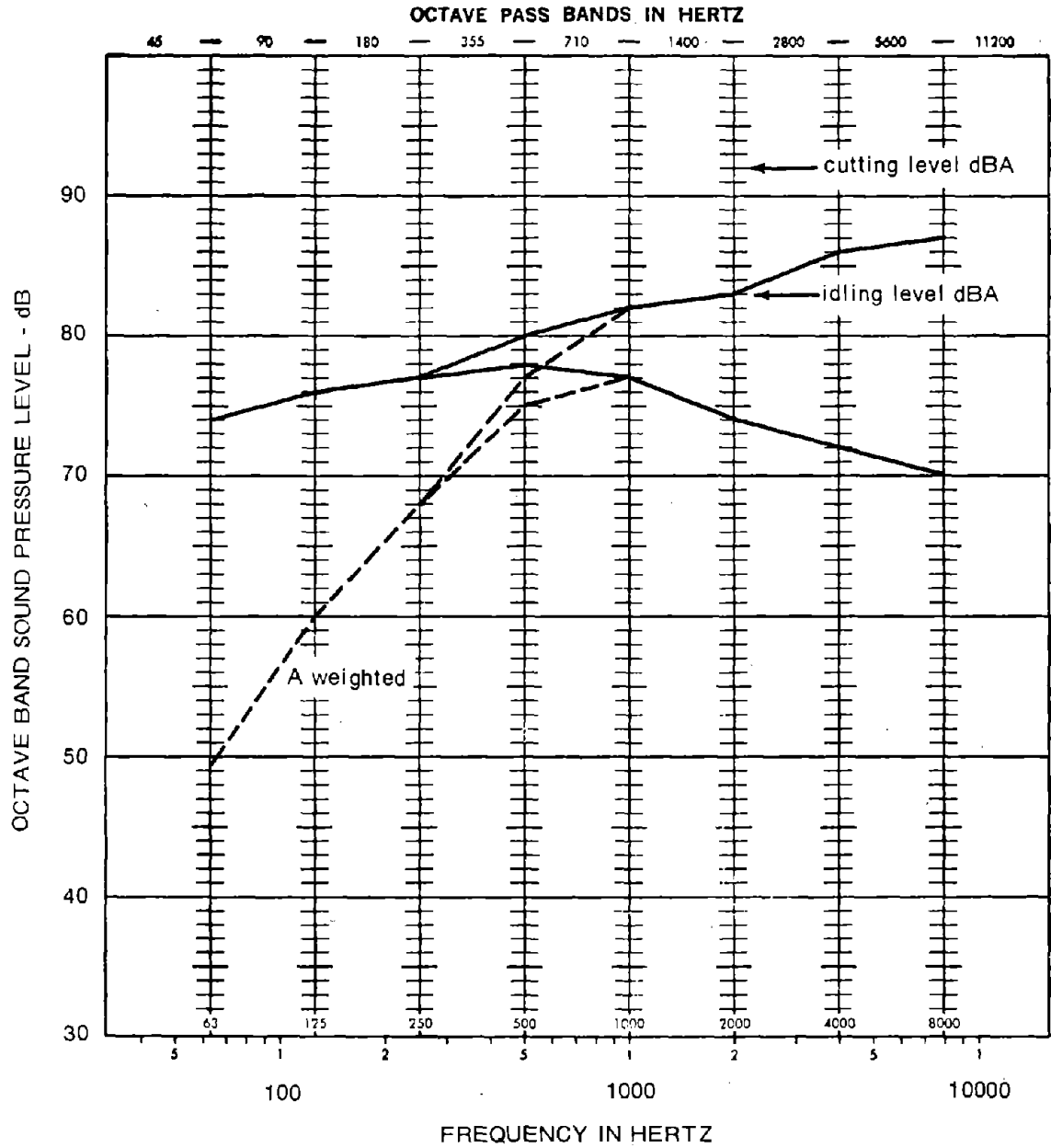

FIGURE 5.15.3 - Straight and cut machine: operator's near field exposure

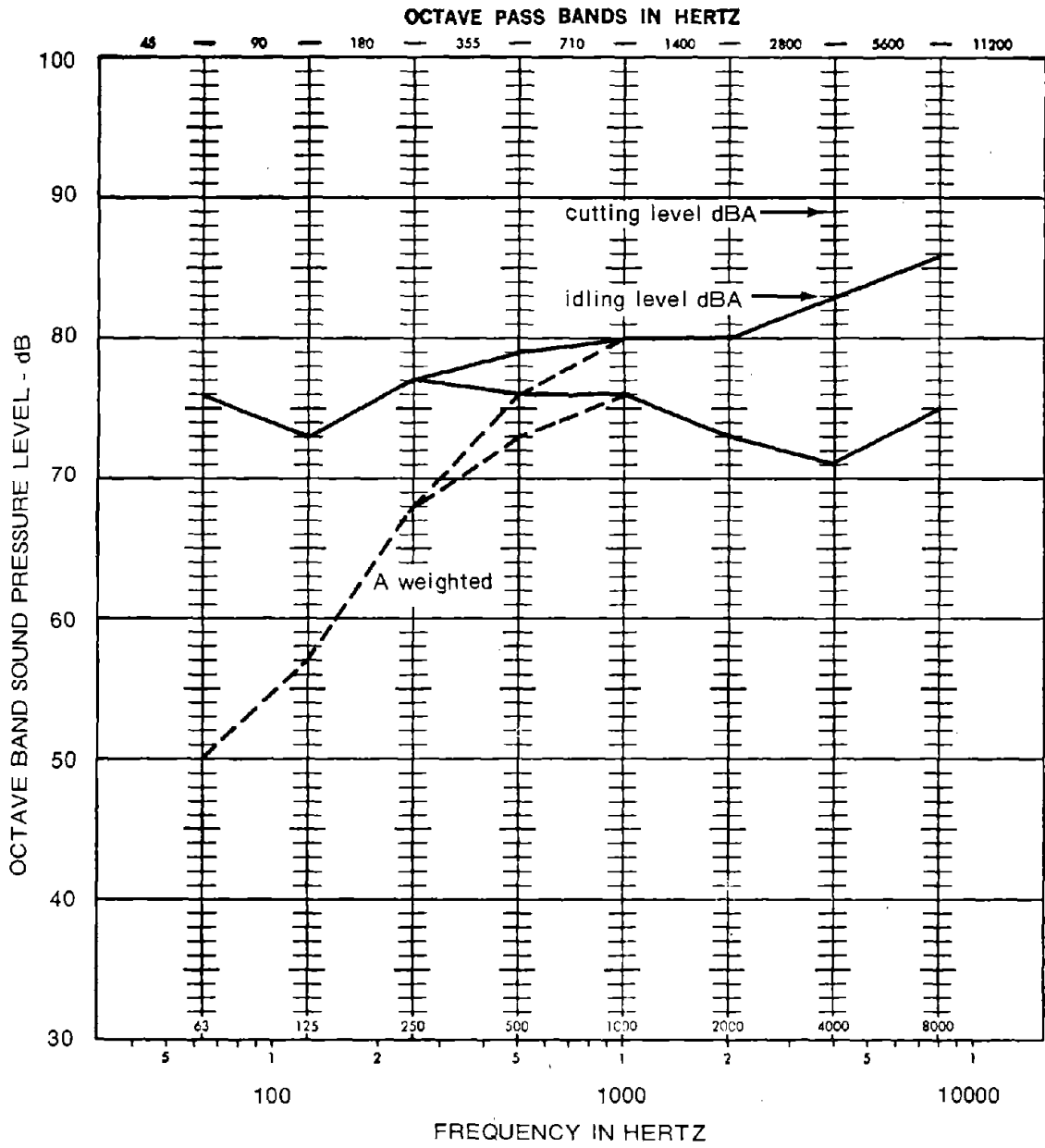

FIGURE 5.15.4 - Straight and cut machine: operator's far field exposure

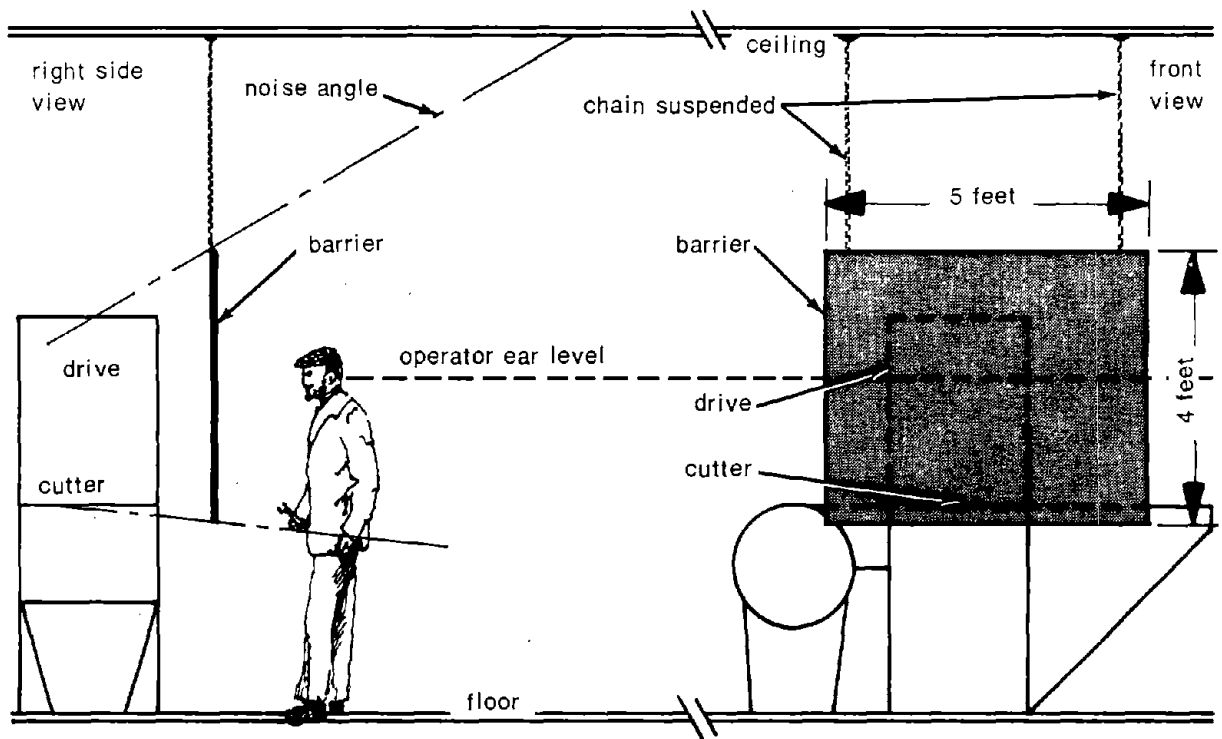

FIGURE 5.15.5 - Barrier wall for straight and cut machine

CASE HISTORY #16 - CUT-PUNCH PRESS IN METAL FABRICATING PLANT

Description of the Problem

This punch press had been modified to produce metal stampings out to a predetermined size. This machine was the first stage of a stamping operation in which the metal was sized and roughly shaped. In two following stages, each part was finished.

Measurement and Analysis

Figure 5.16.1 gives the octave band analysis of the operator exposure, which is 102 dBA while punching and 88 dBA during idling. Figure 5.16.2 shows close-in octave band data for gear noise, illustrating the continuous nonpunching noise source in the gear mechanism. Figure 5.16.3 shows close-in measurements of the dog and flywheel noise. Figure 5.16.4 shows similar close-in measurements of noise from piston-collar impact on the air cylinder.

A reduction of gear mechanism noise 7 dB at 500 Hz, 10 dB at 1000 Hz, and 9 dB at 2000 Hz would reduce the idling, nonpunching level from 88 dBA to 81 dBA. A reduction of dog-flywheel and piston-collar impact by 17 dB at 500 Hz, 21 dB at 1000 Hz, and 25 dB at 2000 Hz would reduce the punching level from 102 dBA to about 85 dBA.

Control Approaches Considered

As machine change was not practical, changes had to be made in the noise transmission path to the operator on two of these noise sources. The other source, piston-collar impact on the air cylinder, was modified at the source by adding washers made from Unisorb Type D pad between the piston stop and the collar to reduce metal-to-metal impact noise.

Control Approach Chosen

The gear noise and dog-flywheel impact noises were attenuated by constructing an extended barrier about these noise sources. To obtain the attenuation required, 1-inch plywood was used. The enclosure was attached to the right side of the press (as the operator looks at press) and extended upward to the top of the press, downward to operator chest level, and outward several inches past the flywheel guard. The top, bottom, and right-hand edges had a small 6-inch extension at the barrier extending 90 degrees away from the operator, as shown in Figure 5.16.5.

An absorbent was added to both sides of enclosure using Mylar-covered 1-inch acoustical foam absorbent available from several

suppliers. The joint between the enclosure and the right-hand side of the press was sealed to prevent noise leakage; a 2-inch-wide strip of closed cell foam weatherstripping was specified.

Normally, absorbing material is used only on the noise source side of a barrier wall; however, if other noise sources might reflect from the barrier wall to the operator, absorbing materials on the operator side will reduce this noise component.

Noise Reduction Achieved

Sound pressure levels during idling were reduced from 88 dBA to 81 dBA. Punch operational sound pressure levels were reduced from 102 dBA to 88 dBA, thus bringing the entire operation into compliance.

Though not recorded, costs are estimated at less than \$200 for plywood, polyurethane foam, and the labor for attachment.

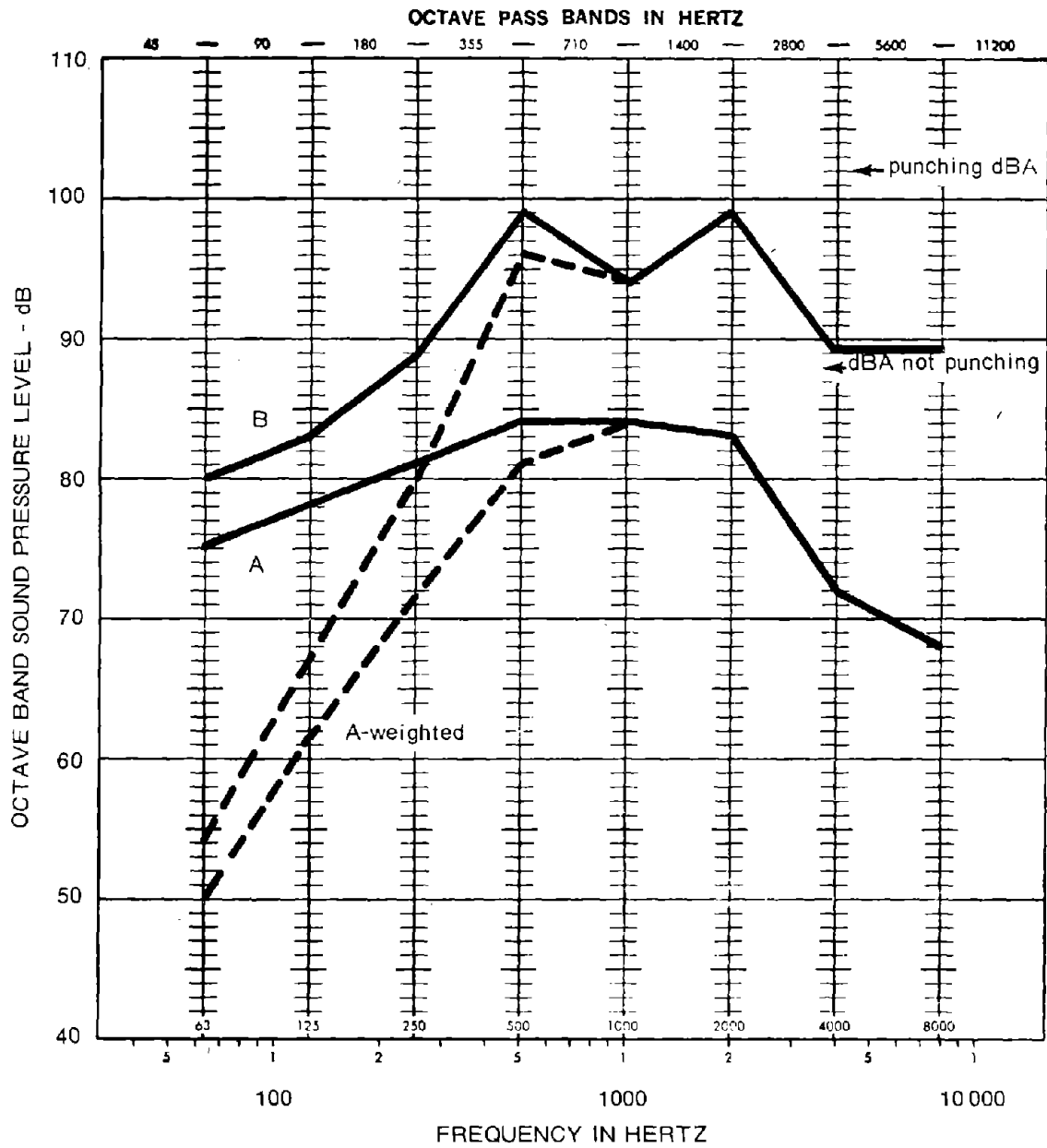

FIGURE 5.16.1 - Cut-punch press, operator's exposure. A, idling; B, punching.

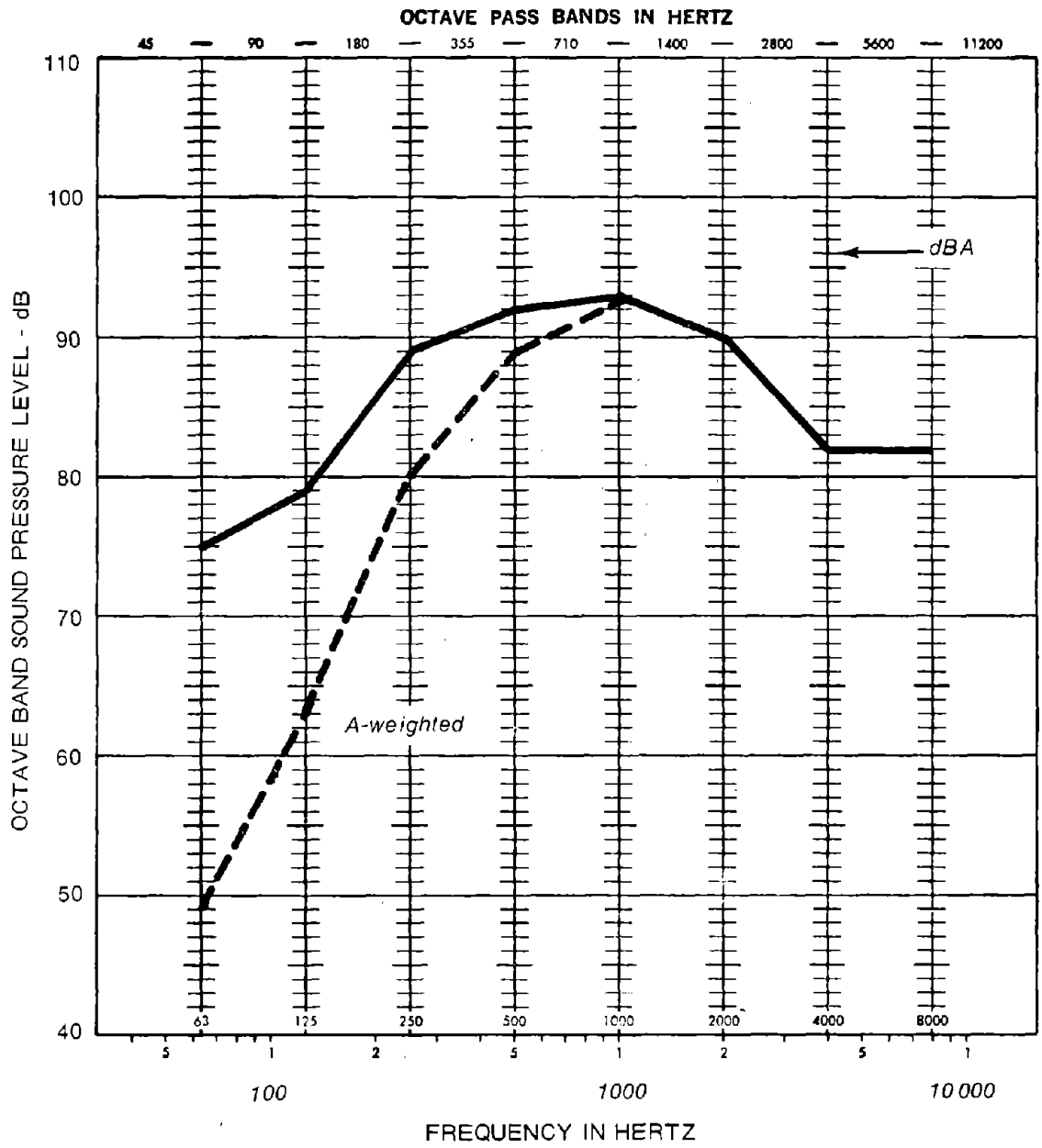

FIGURE 5.16.2 - Cut-punch press, close-in diagnostic data, 14 cm from gears

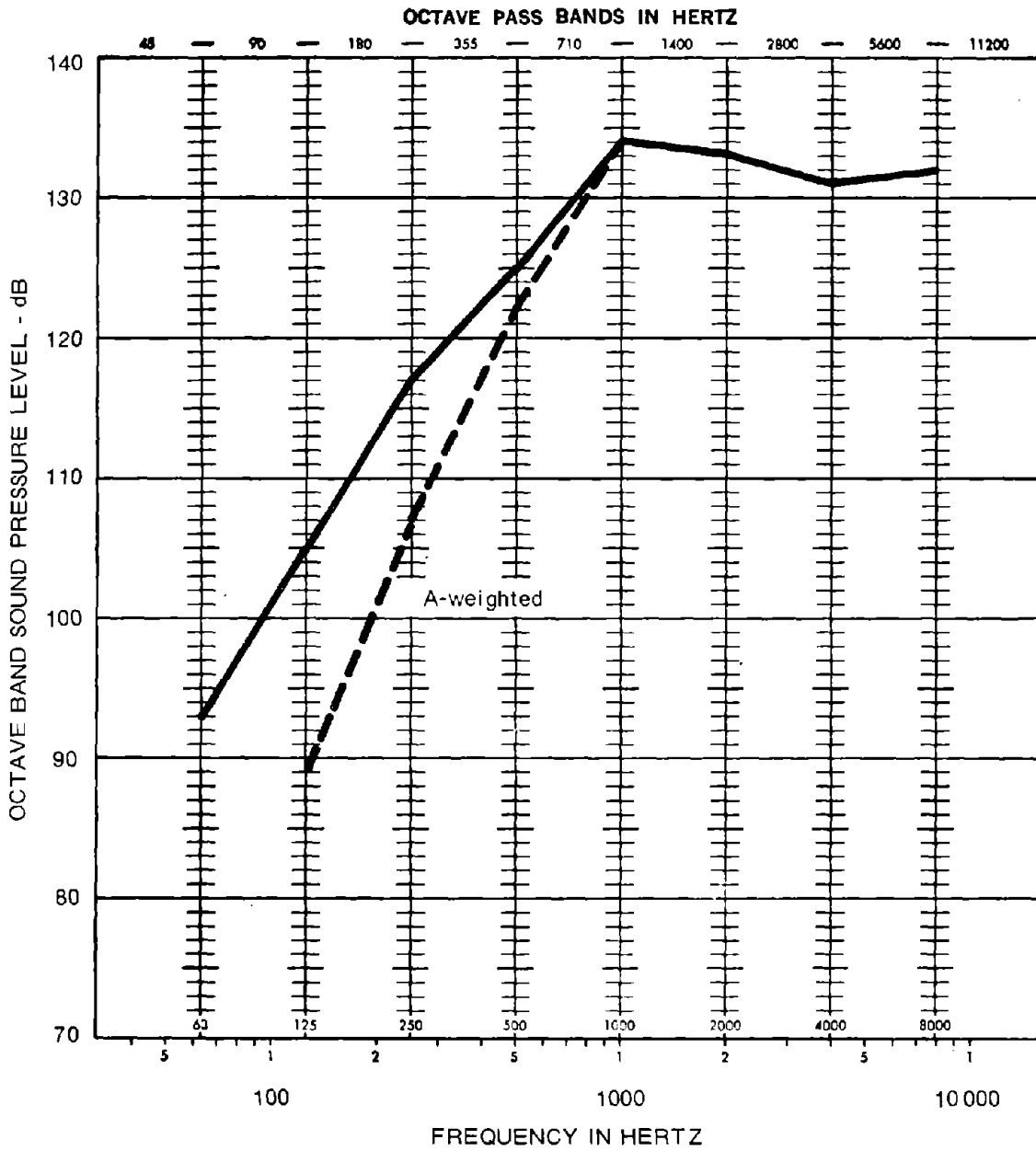

FIGURE 5.16.3 - Cut-punch press, close-in diagnostic data, 5 cm from the dog-flywheel interface

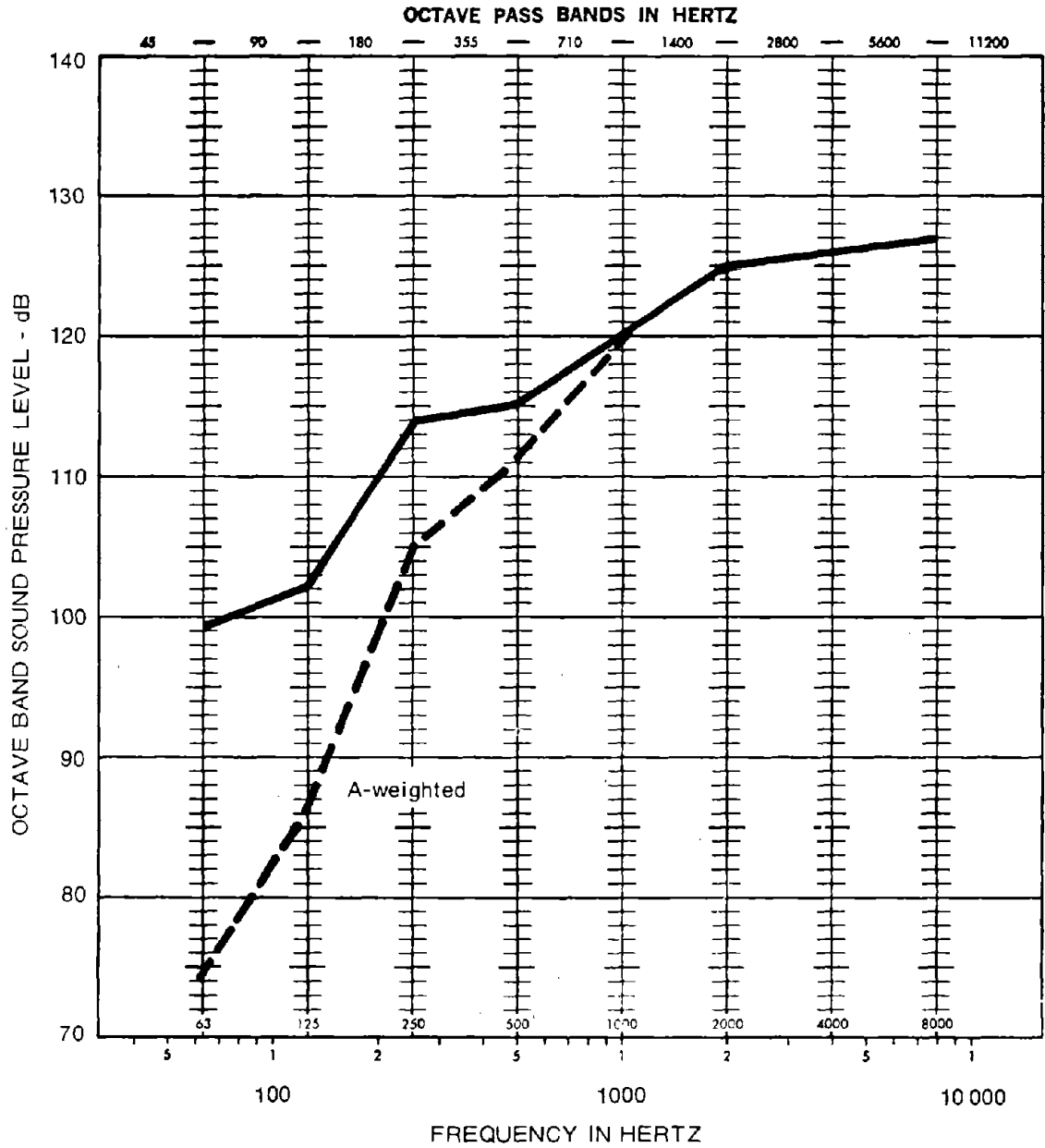

FIGURE 5.16.4 - Cut-punch press, close-in diagnostic data, 5 cm from piston-collar impact on air cylinder

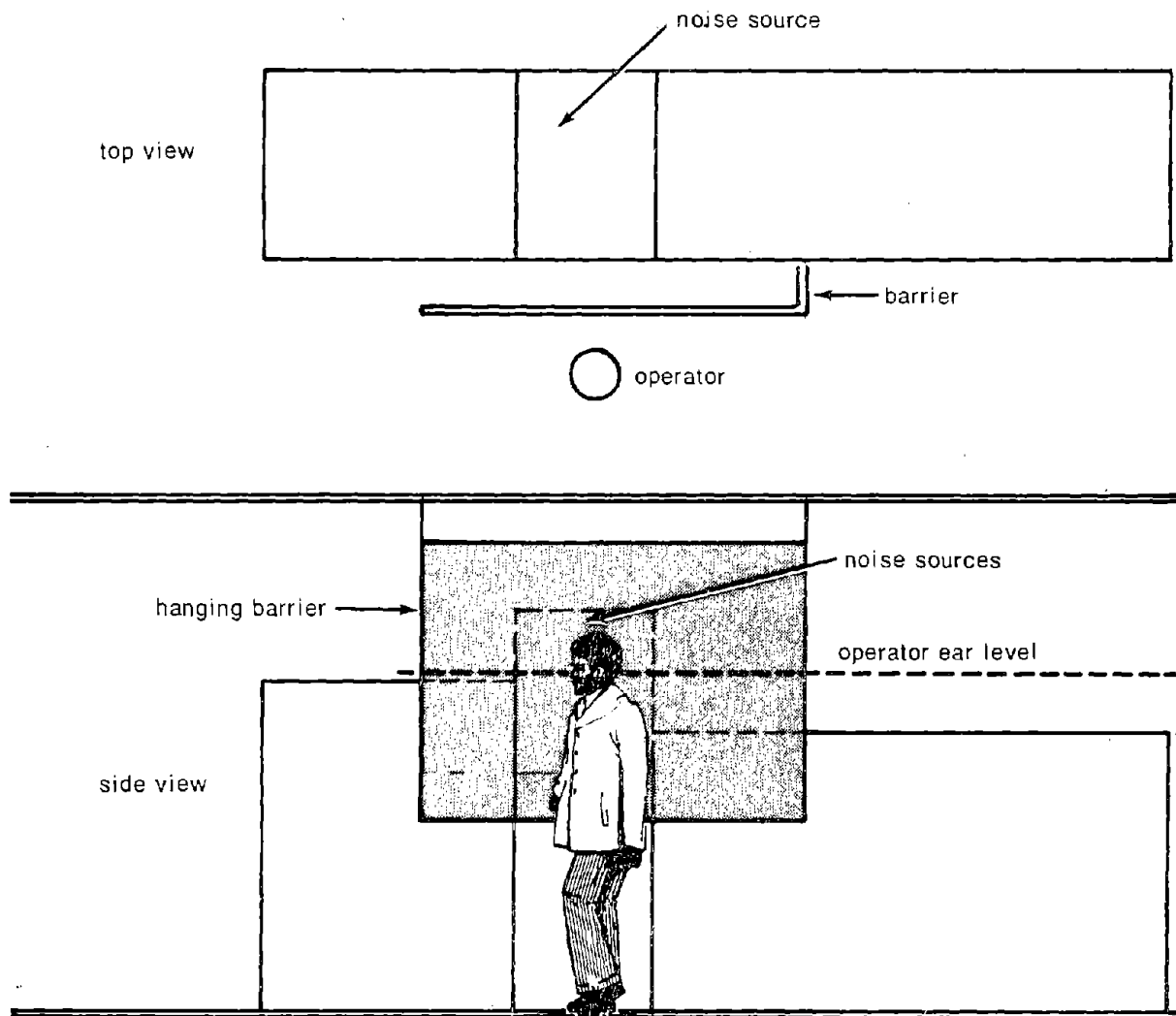

FIGURE 5.16.5 - Sketch of hanging barrier for cut-punch press

CASE HISTORY #17 - PARTS CONVEYING CHUTE

This case was taken from published data*, because of the importance of illustrating the method for other applications.

Description of the Problem

Chutes for conveying small parts can radiate much noise from the impact of parts on the sheet metal of the chute. The noise (for a given part) can be reduced by keeping to a minimum the distance the part must fall to the chute. For reducing the remaining noise, the chute must be stiffened and damped.

Control Approach Chosen

Constrained layer damping is used, in which the treatment can be placed on either the parts side or the underside of the chute. If placed on the parts side, the metal layer should be wear-resistant to the impacting parts. In this example, 30-caliber cartridge cases were carried in the chute shown in Figure 5.17.1. The bottom of the chute was 14-gauge steel, which was lined with 0.035-inch cardboard and then covered with a wear plate of 20-gauge galvanized steel. Rubber deflector plates were positioned to funnel parts to the center of the chute, so that they would not hit the untreated sides of the chute.

Noise Reduction Achieved

Figure 5.17.2 shows the spectra measured 3 feet to one side of the chute. The level has been reduced from 88 dBA to 78 dBA, a decrease of 10 dB. Greater reduction could have been obtained if multiple layers of thinner cardboard were used (in solid contact with the cover sheet). Still better would be replacement of the cardboard by commercially available damping materials specifically formulated for constrained layer use.

Pitfalls

Much noise still comes out of the top of the conveyor. A cover over it, lined with absorbent, should reduce the noise an additional 5 to 10 dB. Prior to any noise control effort, the relative amounts of noise from top and bottom should be determined. Ordinarily damping is always to be used.

* Cudworth, A. L., Field and Laboratory Example of Industrial Noise Control. Noise Control 5 (1): 39, 1959.

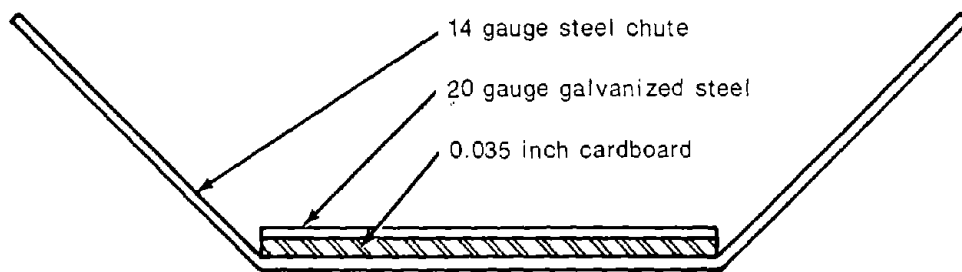

FIGURE 5.17.1 - Chute for conveying cartridge cases

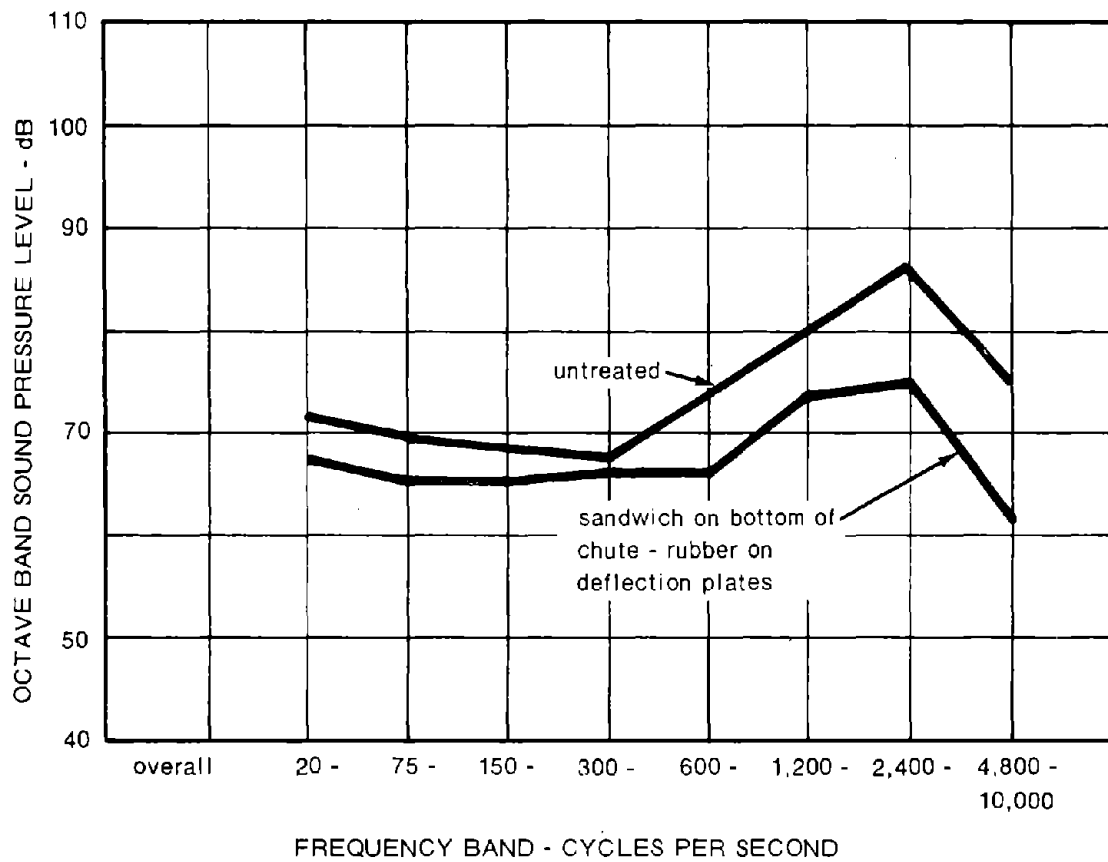

FIGURE 5.17.2 - Noise spectra measured 3 feet from chute

CASE HISTORY #18 - NAIL MAKING MACHINE*

Description of the Problem

A nail making machine was operating under conditions causing severe impacts. The vibration was solidly transmitted to a weak concrete floor, which radiated considerable noise. There were 10 machines, operating at 300 strokes per minute. Operator noise level was 103.5 dBA.

Measurement and Analysis

An octave band analysis was made at the operator position and is shown in Figure 5.18.1.

Control Approach Chosen

It was decided to use vibration isolating mounts to reduce floor radiated noise. Because of the repeated shock situation, selection at the isolator followed these rules:

- (1) The natural period of isolator plus machine should be much greater than the shock pulse duration (10 msec).
- (2) The natural period of isolator plus machine should be less than the time between pulses (200 msec).

Elastomer type isolators were used, having a static deflection of 0.1 inch under machine load. This corresponds to a natural period of 100 msec, thus fulfilling the design conditions.

Noise Reduction Achieved

Figure 5.18.2 shows octave band spectra at the operator's position after all machines had been vibration isolated. The A-levels have been reduced about 8.5 dB to 95 dBA. This is still in excess of permitted levels, and additional noise control is needed.

Pitfalls

To maintain the isolation, maintenance people should be warned not to short-circuit the isolators by any solid connection from machine to floor. This short-circuiting can also occur when dirt and grease are allowed to build up around the pods.

* From Crocker, M. J., and J. F. Hamilton, Vibration Isolation for Machine Noise Reduction. Sound and Vibration 5 (11): 30, 1971

Additional Noise Reduction

As a reduction to a noise level of 95 dBA is not considered satisfactory for full day operator exposure, additional noise reduction could be obtained by the design of a barrier between the major noise source in the machine and the operator. Depending on the needs for vision through the barrier, plywood, lead-filled vinyl curtain, or Plexiglas could be used. Such a barrier should yield a reduction of 5 to 8 dBA at the operator position. (For calculated design parameters, see Case History #6 and for rule of thumb parameters, see Case History #10.) This noise reduction should result in compliance with 87 to 90 dBA.

Where there is a series of machines, additional reduction of several decibels could be obtained by added room absorption, either in the form of spray-on acoustic absorbent on ceilings and walls or in the form of hanging absorbent baffles from the ceiling. (See Chapter 3 on Room Acoustics.)

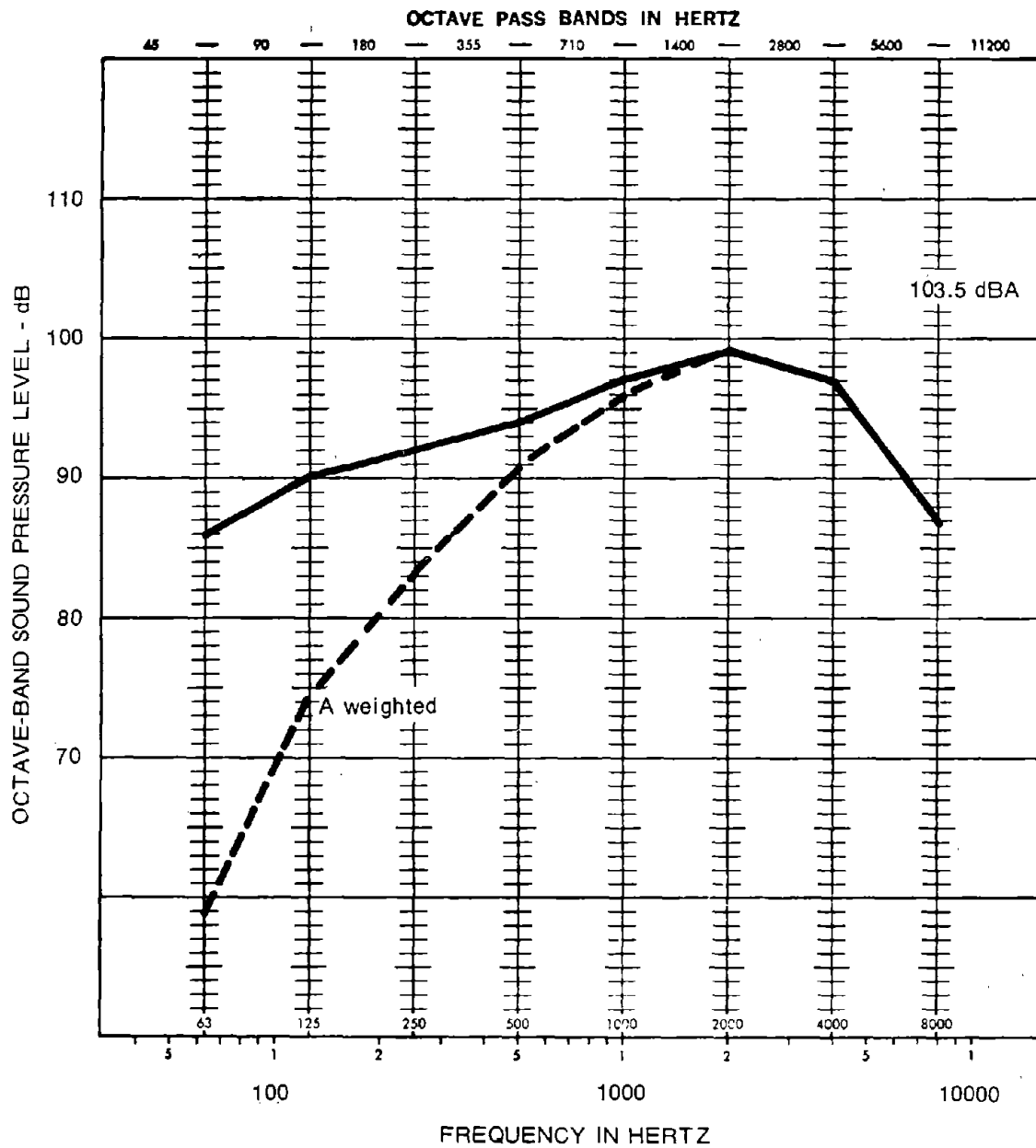

FIGURE 5.18.1 - Nail making machine: operator position noise levels

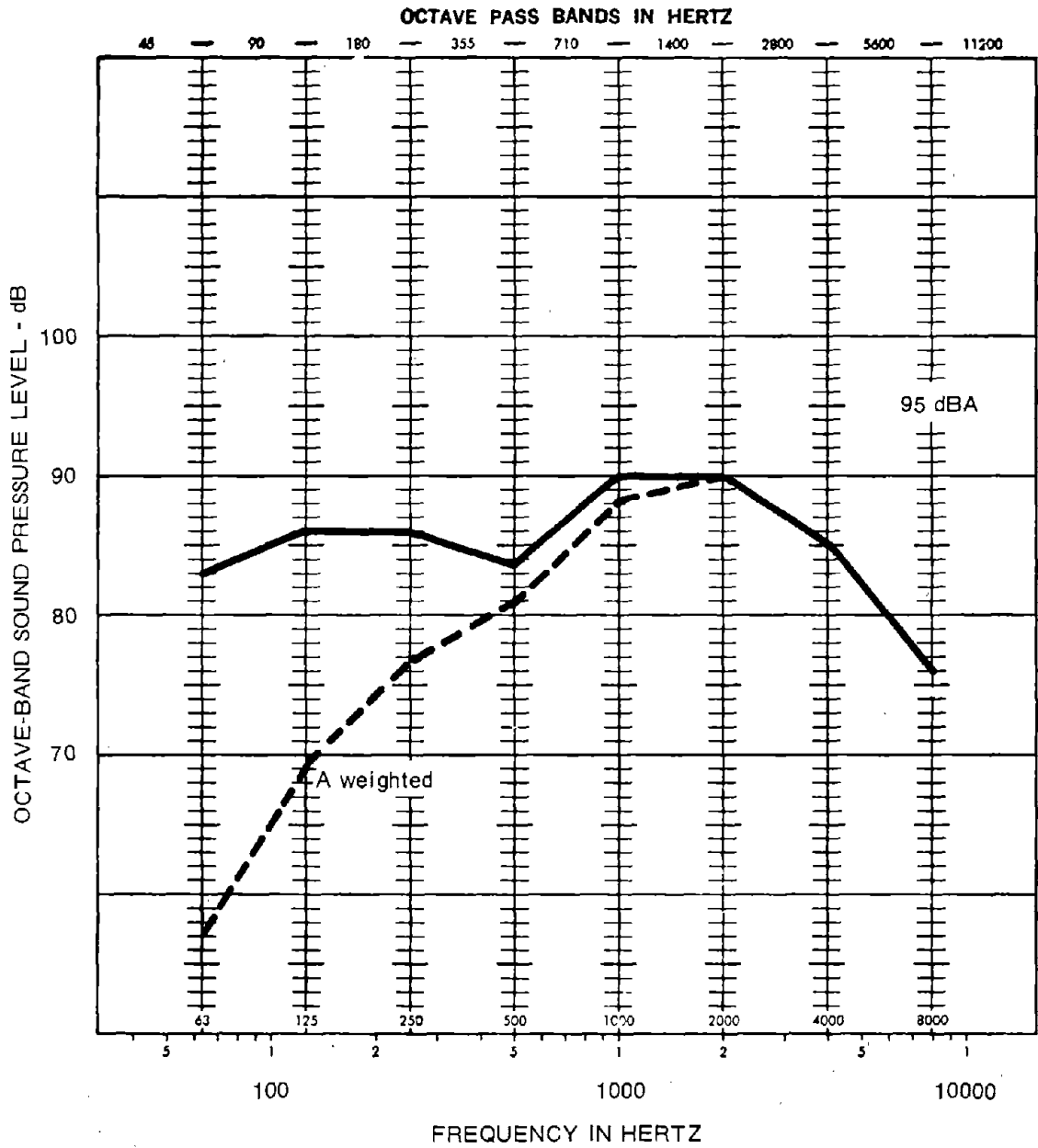

FIGURE 5.18.2 - Nail making machine: operator position noise levels after vibration isolators instal

CASE HISTORY #19 - WOOD PLANER*

Description of the Problem

Wood planers use a high-speed rotating cutter head to produce lumber with a finished surface. Noise levels to the operator are high.

There are apparently many noise sources for investigation:

- (1) The board, excited by cutter knife impacts.
- (2) The heavy structure under the cutter head, excited by vibration transmitted through the board.
- (3) Modulation of air flow by cutter knife chopping at the chip collector air stream.
- (4) Motor windage, hum.
- (5) Dust collector blower, vibration noise.
- (6) Machine surfaces excited by impacts.

Measurements and Analysis and Control

The octave band operator levels are shown in Figure 5.19.1. Analysis resulted in the following possibilities for control of planer noise:

- (1) Restrain the board from vibrating. Feed belts on both sides can be used with considerable backup mass and pressure. This would require a radical machine design change.
- (2) Contact the board by means that add damping, to reduce resonant vibration. If this is done as an add-on, it must occur beyond the feed and delivery ports of the planer. Thus it would be helpful only for long lengths of board.
- (3) Use a helical knife cutter head, which will also reduce idling noise. A helix angle larger than is commonly available would be desirable.

* Stewart, J. S., and F. D. Hart, Analysis and Control of Wood Planer Noise. Sound and Vibration 6 (3): 24, 1972.

- (4) Enclose the planer and board. This is a brute force method that depends for its success on controlling the amount of sound that escapes from the feed and delivery areas; most of the sound contributing to A-level noise is between 500 and 5000 Hz. This increases the enclosure design problem, because enclosures are more effective at high frequencies. (See Case History #24.)

Noise Reduction Achieved

Results achieved by the helical knife cutter head are shown in Figure 5.19.2: reduction from 106 dBA to 93 dBA. Figure 5.19.3 shows the operator noise level related to length of board planed, comparing the helical knife cutter with the straight knife cutter. The helical knife is by far the quieter.

Pitfalls

To meet OSHA operator levels for full day operation, the plant would need to make further noise level reduction, perhaps by the design of a total enclosure with an acoustic lined tunnel for the in-feed and out-feed. This should not be tried until it has indeed been determined that the openings are the chief sources. In many mills, however, the planer is not operated on a full-time basis, thus allowing a higher noise level for the shorter time period that an operator is present. At 93 dBA, 5.3 hours is permitted.

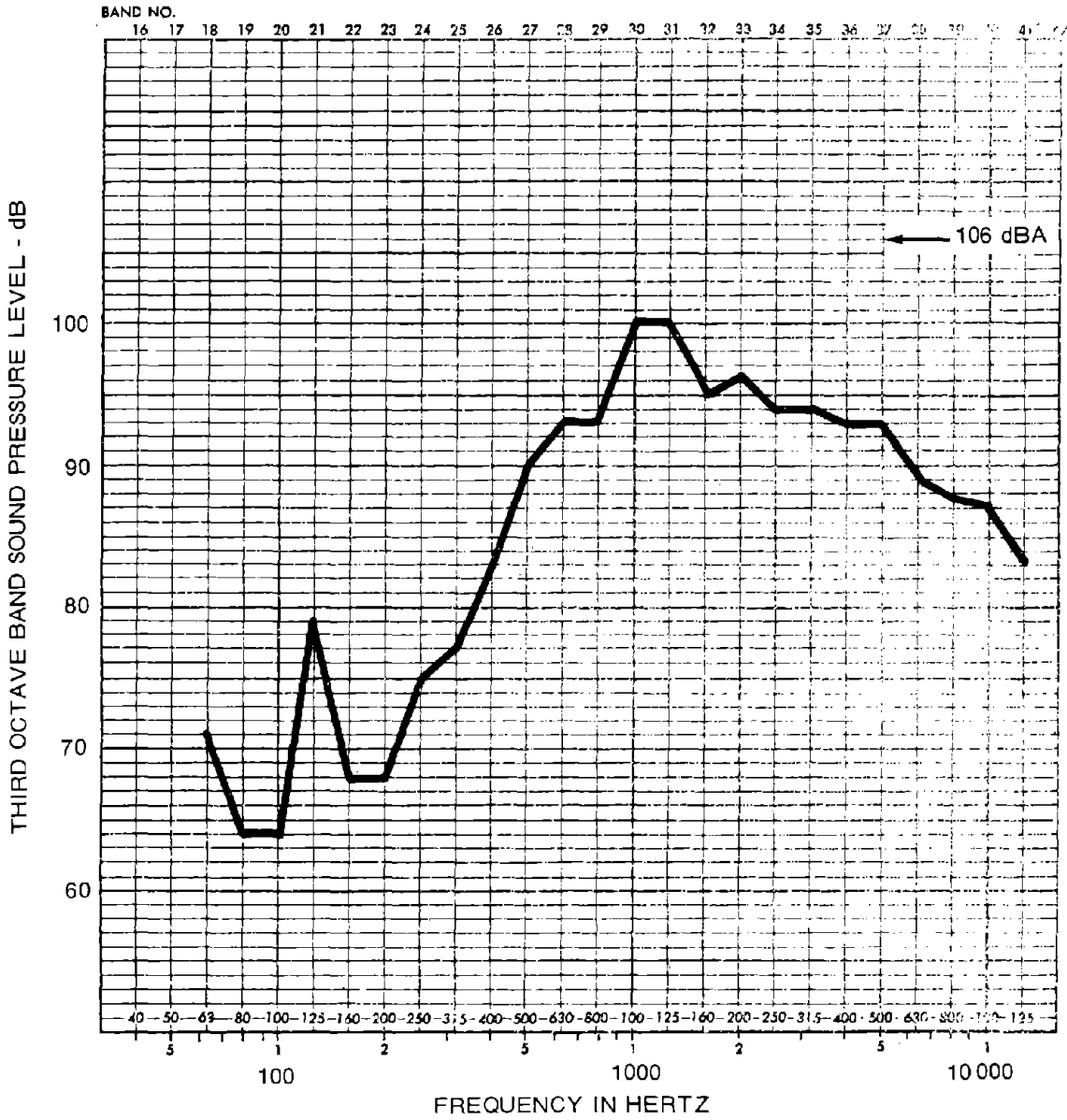

FIGURE 5.19.1 - Noise levels for wood planer - straight cutter

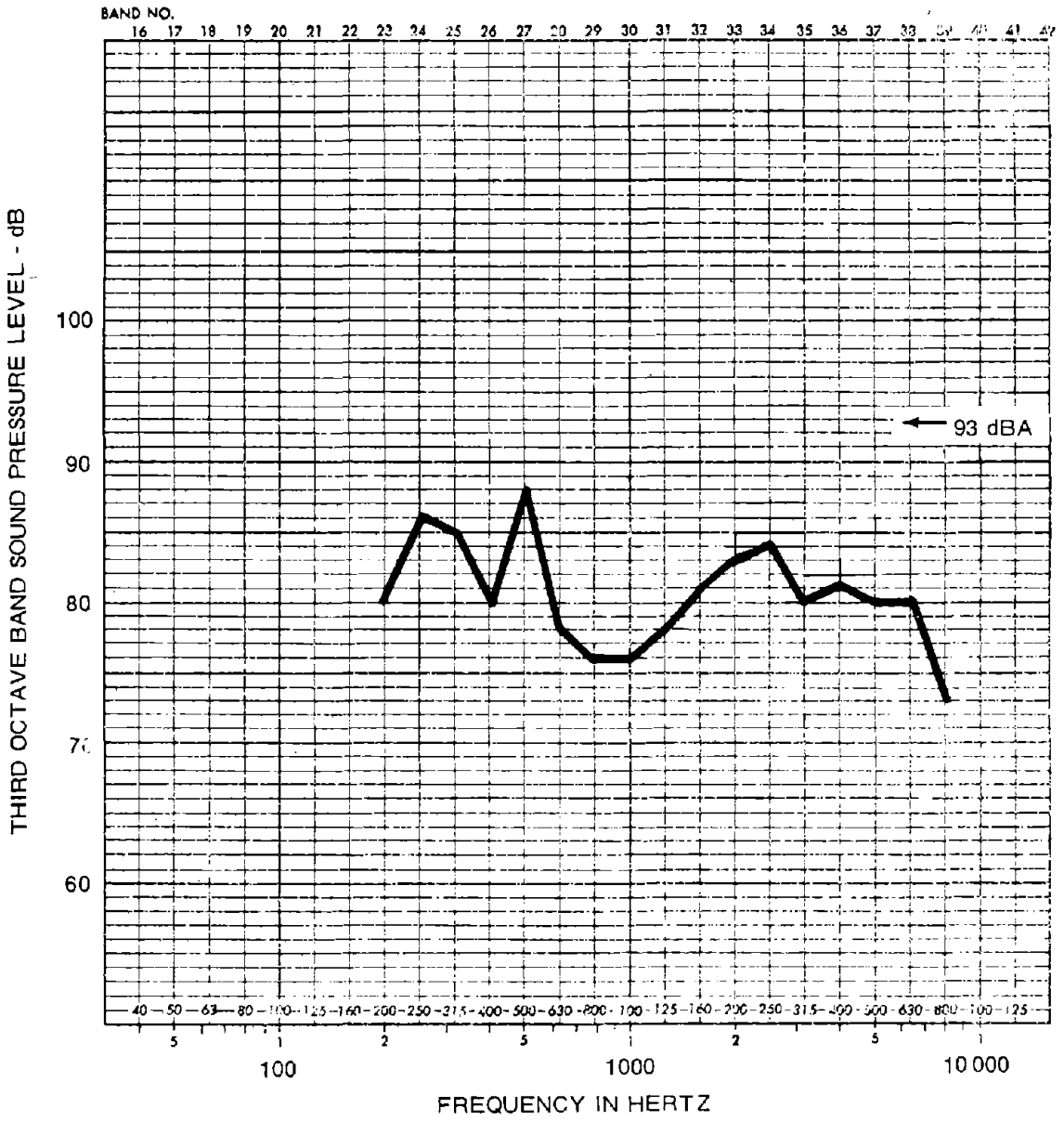

FIGURE 5.19.2 - Noise levels for wood planer with helical cutter

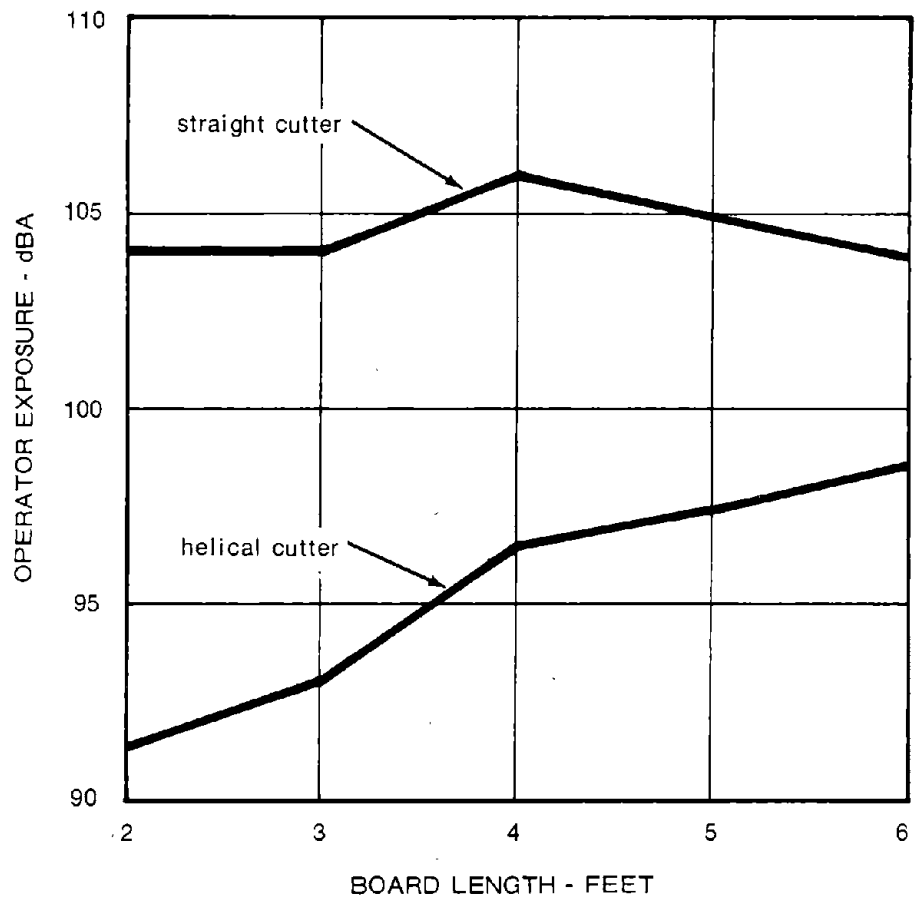

FIGURE 5.19.3 - Effect of board length on noise from wood planer

CASE HISTORY #20 - PUNCH PRESS*

Description of the Problem

Punch presses constitute a most troublesome source of industrial noise, both because of their number and because of their high noise output.

From various papers on the subject of punch presses, the following list of noise sources has been gathered. These may not all be present on any one press but are listed as a guide to specific press noise source analysis.

- (1) Shock excitation of the workpiece, machine guards, floor and building.
- (2) Gears, drive, bearings, and components, such as clutch and brake mechanism and drive shaft.
- (3) Plunger resonance.
- (4) Air ejection, air jet cleaning, and air cylinder exhausts.
- (5) Die design.
- (6) Stripper plate design.

* American Industrial Hygiene Association, Industrial Noise Manual, Detroit, 1966. Examples 11.C, 11.EE.

Allen, C. H., and R. C. Ison, A Practical Approach to Punch Press Quieting, Noise Control Engg. 3 (1): 18, 1974.

Bruce, R. D., Noise Control of Metal Stamping Operations. Sound and Vibration 5 (11): 41, 1971.

Shinaishin, O. A., On Punch Press Diagnostics and Noise Control. Proc. Inter-Noise 72: 243, 1972.

Shinaishin, O. A., Sources and Control of Noise in Punch Presses, Proceedings Purdue University Conference on Reduction of Machine Noise, May 1974, page 240.

Stewart, N. D., J. A. Daggerbart, and J. R. Bailey, Identification and Reduction of Punch Press Noise. Proc. Inter-Noise 74: 225, 1974.

- (7) Ejection of parts leaving press on chute or bin.
- (8) Vibration of sheet metal being fed to the press.
- (9) Start and stop of automatic feed to the press.
- (10) Building acoustics.

Control Approaches Considered

Shock excitation of surrounding structures--This effect can be minimized by properly designed vibration mounts for the entire press to reduce excitation of floors, walls, and other equipment. As an example of this see Case History #2.

Drives, etc.--Good maintenance can contribute to noise reduction. The noise of drive gears can be reduced by damping the gear body, improving gear surface quality and tolerances, precision installation and bearings, better lubrication, and/or changing gear material for a better damped material. On existing equipment many of the above aids cannot be done at reasonable expense, but gear drives are often enclosed in a box-like structure whose surfaces radiate noise. These surfaces can be damped with off-the-shelf materials, or the drive unit, if space is available, can be enclosed, fully or partially. Heat dissipation must be considered. Solid metal or plastic guards can be changed to expanded metal or wire mesh for less noise, or the guard surface can be vibration damped. The entire guard, if solid, must be vibration isolated from the vibrating machine.

Plunger resonance--If a hollow plunger or ram is a Helmholtz resonant type of noise source, its noise radiation can often be reduced by covering the hole in the plunger. See Case History #4.

Air ejection of punched parts--If possible, substitute mechanical ejection to eliminate a large noise source. One comparison, shown in Figure 5.20.1, (AIHA 1966) resulted in an 8-dBA noise reduction. Multiple jet nozzles are also available for reduced noise. Reduce to a minimum the air velocity used for ejection (since noise level is related to velocity) by reducing the air pressure available. Achieve better efficiency of air jet by accurate setting and aiming where needed.

Shield the area of punch-air ejection from the operator. An example of the result of this method, in Figure 5.20.2, shows the noise levels of a press with and without a 24 x 48 inch shield to protect operator from air ejection noise.

Die design--Changes in die design can reduce noise by attempting to design for spreading the punching action, slanting the blanking punch or die, or other means of promoting consecutive shear action instead of instant action. Shinaishin reported the results of a slanted die as shown in Figure 5.20.3. Changes in die materials can reduce noise. As presses produce sound energy from vibration of metal plates upon impact, the velocity of impact can be reduced by using hard rubber mounts (snubbers). Another possibility is laminated and more massive plate, reducing the size of plate and radiating area.

A change of work stock material from steel to a lead-steel composition has also reduced impact noise; Shinaishin reported a 14-dB reduction with this test method. Noise radiation can be lessened by reducing plate area by cutting out any surface areas that perform no function.

These comments emphasize that the tool engineer must now consider designing for noise reduction as well as for mechanical performance. Within such general framework outlined, any improvements in noise level will come by experiment and testing results.

Stripper plates--Stripper plates in some dies contribute to noise levels due to metal-to-metal contact, which could be changed to plastic or elastomeric contact with better damping and reduced noise.

Ejection of parts to chute or bin--Noise levels can be reduced by damping metal chutes, using damping materials on the market or making a constrained layer design. See Case History #17.

Vibration of sheet metal being fed to press--Noise levels can be reduced by preventing vibration, such as by adding a hold-down conveyor. The noise can also be constrained by using an acoustic tunnel in-feed, or the operator can be shielded by properly designed barriers.

Start and stop feed mechanisms--Noise can be reduced by redesign: substitute plastic contact areas where possible; enclose the noise source partially; or add barriers between noise source and operator.

Building acoustics--In a room with many noise sources, the operator may be in the reverberant field. Such noise can be reduced by adding absorption. From Bruce, an example of use of absorption to reduce noise in a press room is shown in Figure 5.20.4, 30 feet from presses. Closer to presses, noise reduction would be less with probably no more than 2 to 3 dB at the operator position. The press area can also be enclosed or walled off from the rest of the plant.

Use of Enclosures

Allen and Ison (1974), P.18, reported a partial enclosure of ram, die, in-feed, and ejection on a 50-ton test press. A reduction of 13 dBA was obtained for an enclosure; see Figure 5.20.5. The model enclosure was made of cardboard, $\frac{1}{2}$ lb/sq ft, lined with 1 in. of polyurethane foam. Later a steel enclosure was installed, for durability.

Total enclosures with opening via an acoustic tunnel may be required and should follow recommended enclosure design as reviewed in Chapter 3.

Pitfalls

The remaining radiation came chiefly from the flywheel cover, which was neither damped nor vibration isolated. Diagnostic measurements should indicate the relative contributions from each source, so that the residual noise will be known.

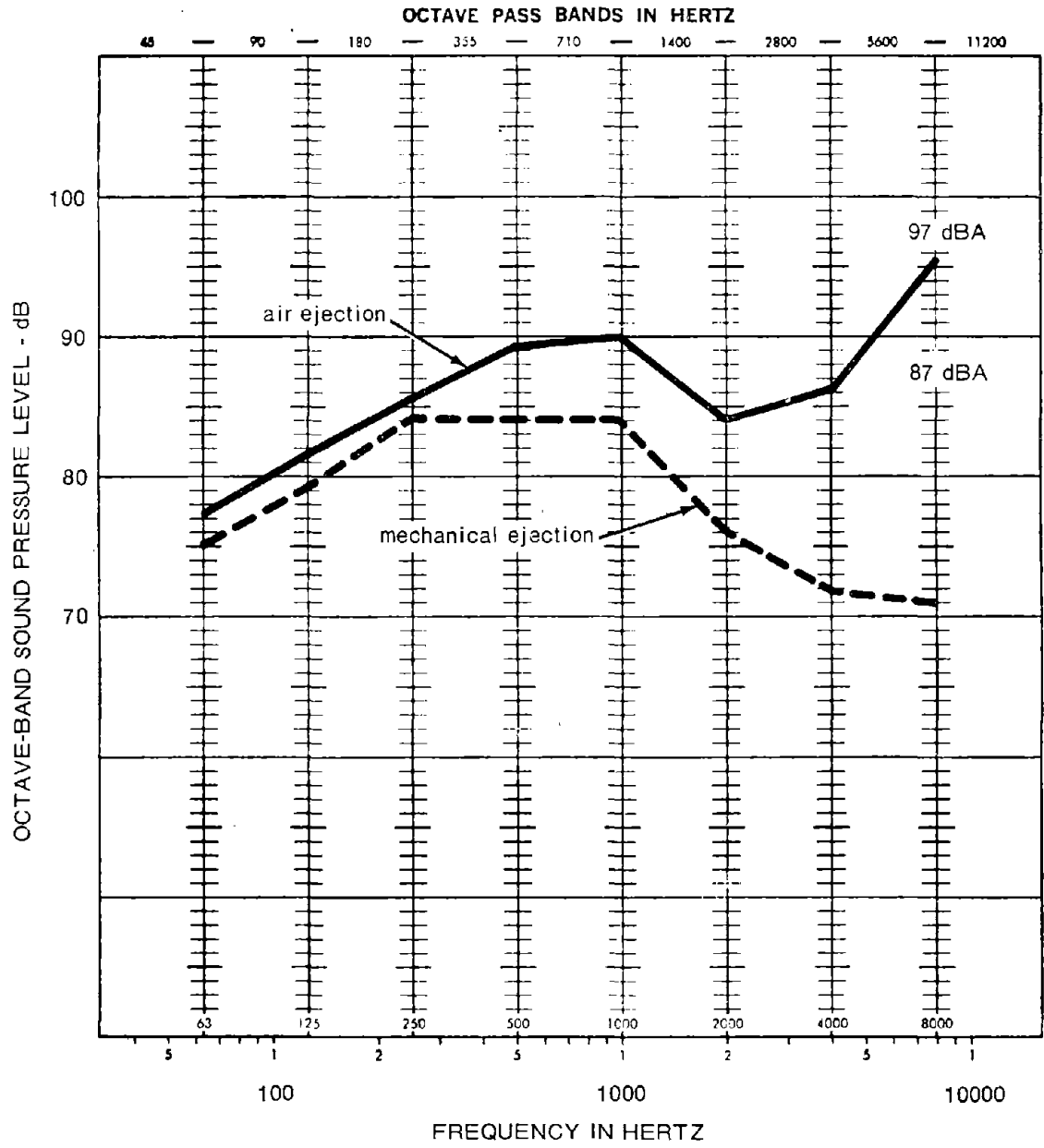

Source: AIHA, 1966.

FIGURE 5.20.1 - Comparison of punch press noise levels with air ejection and with mechanical ejection

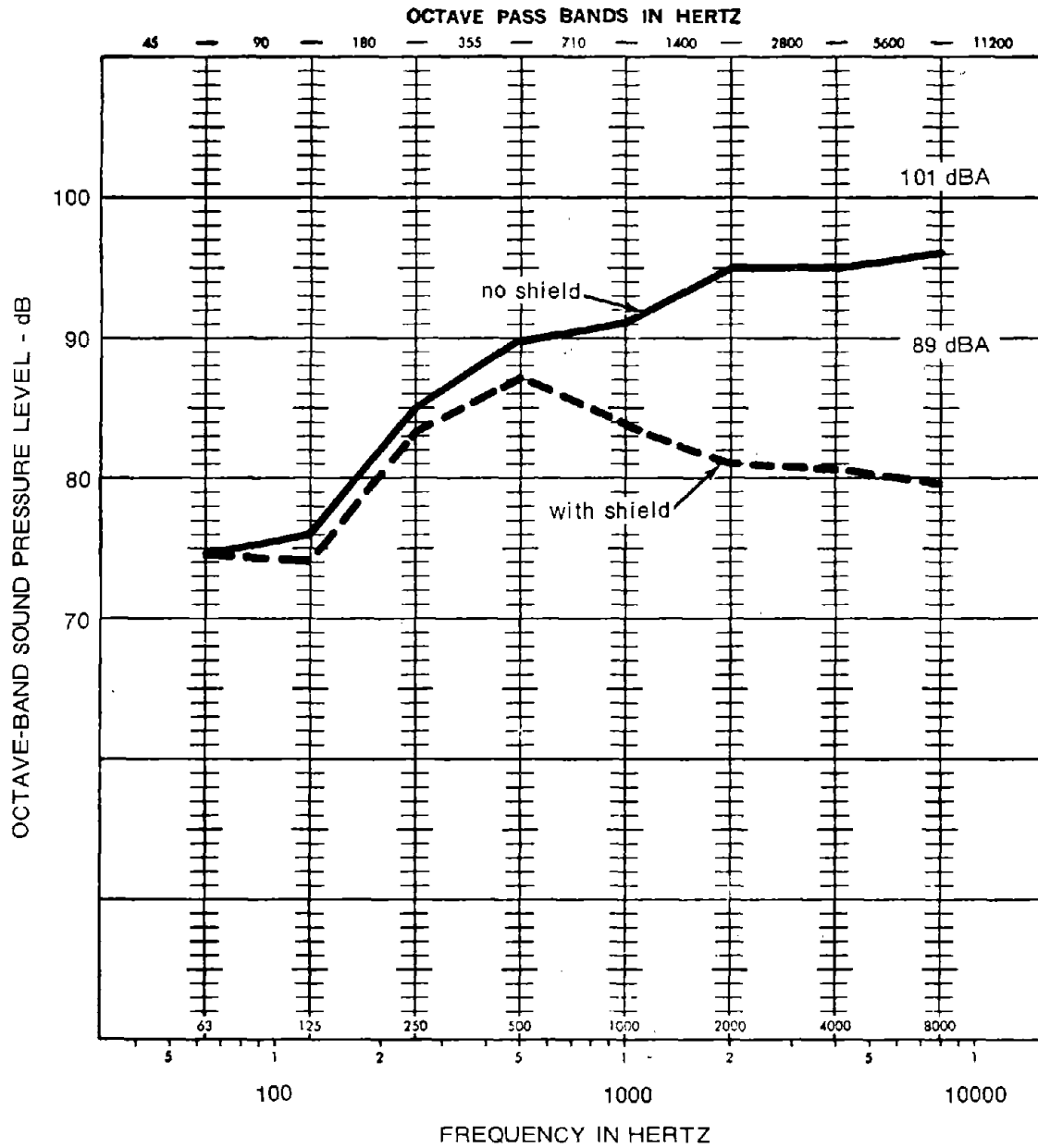

Source: AIHA, 1966.

FIGURE 5.20.2 - Comparison of punch press noise levels with and without a shield between operator and air ejection noise

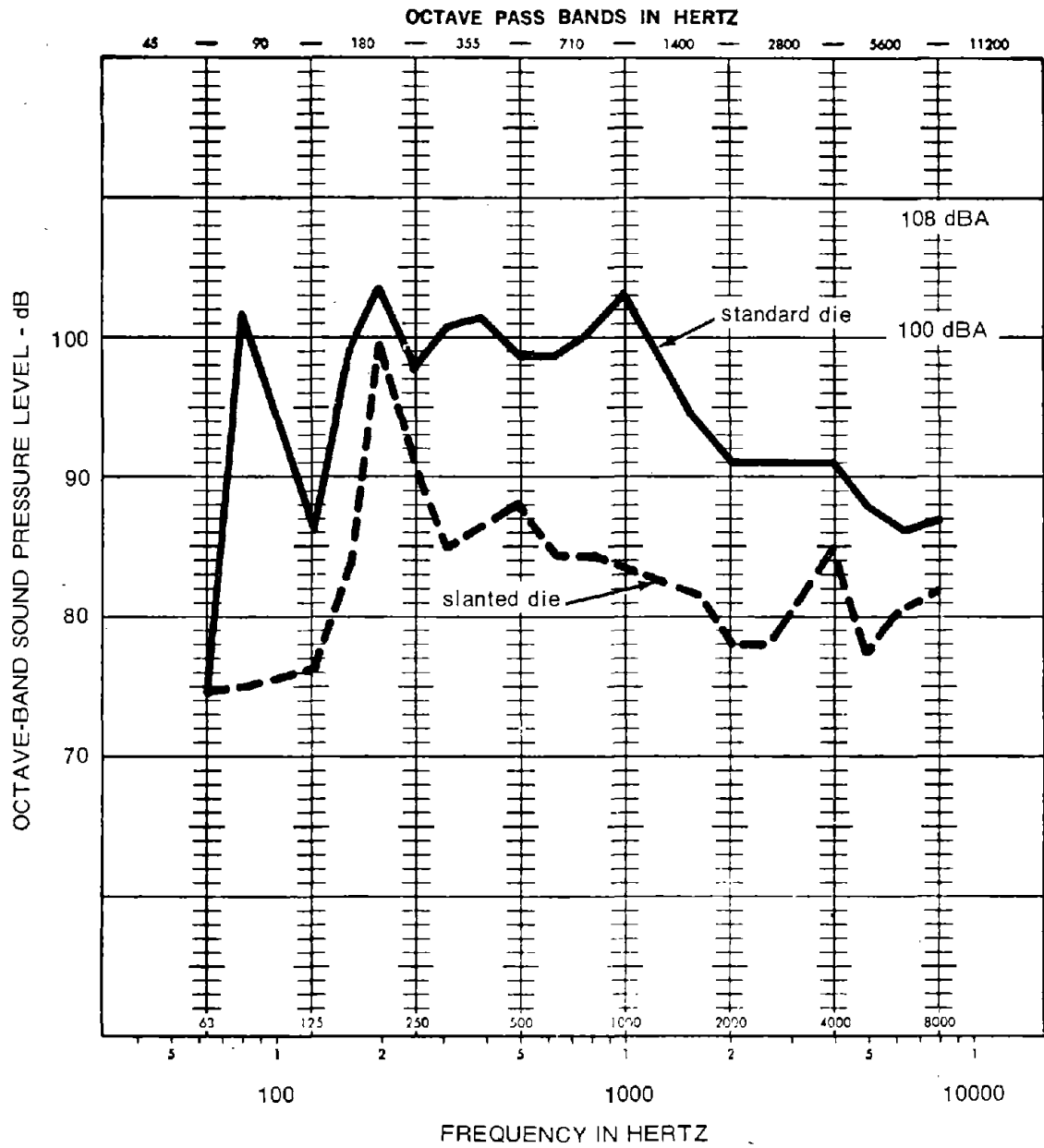

Source: Shinaishin, 1972.

FIGURE 5.20.3 - Comparison of punch press noise levels: standard die versus slanted die

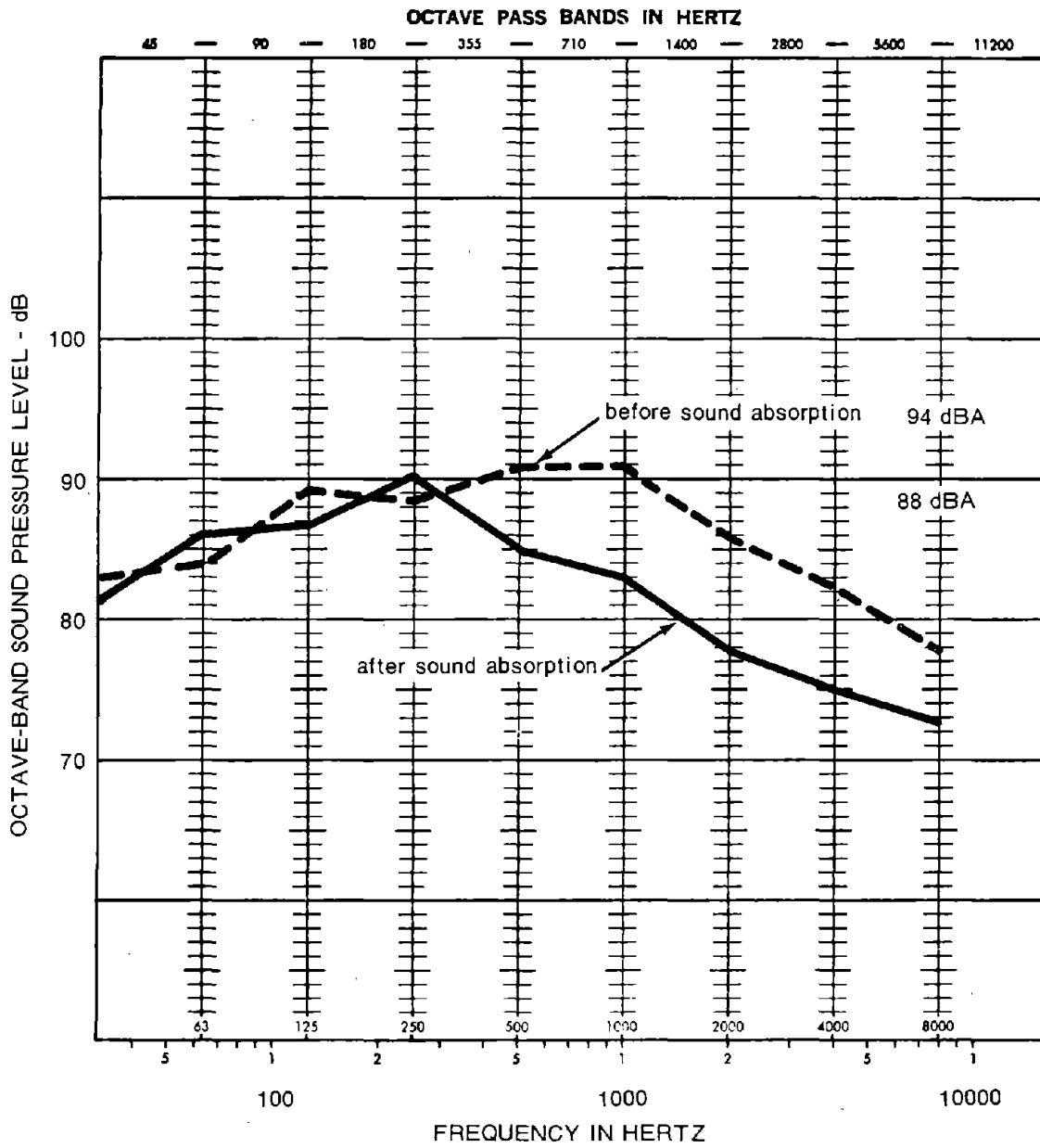

Source: Bruce, 1971.

FIGURE 5.20.4 - Noise levels 30 feet from bench press area before and after sound absorption treatment

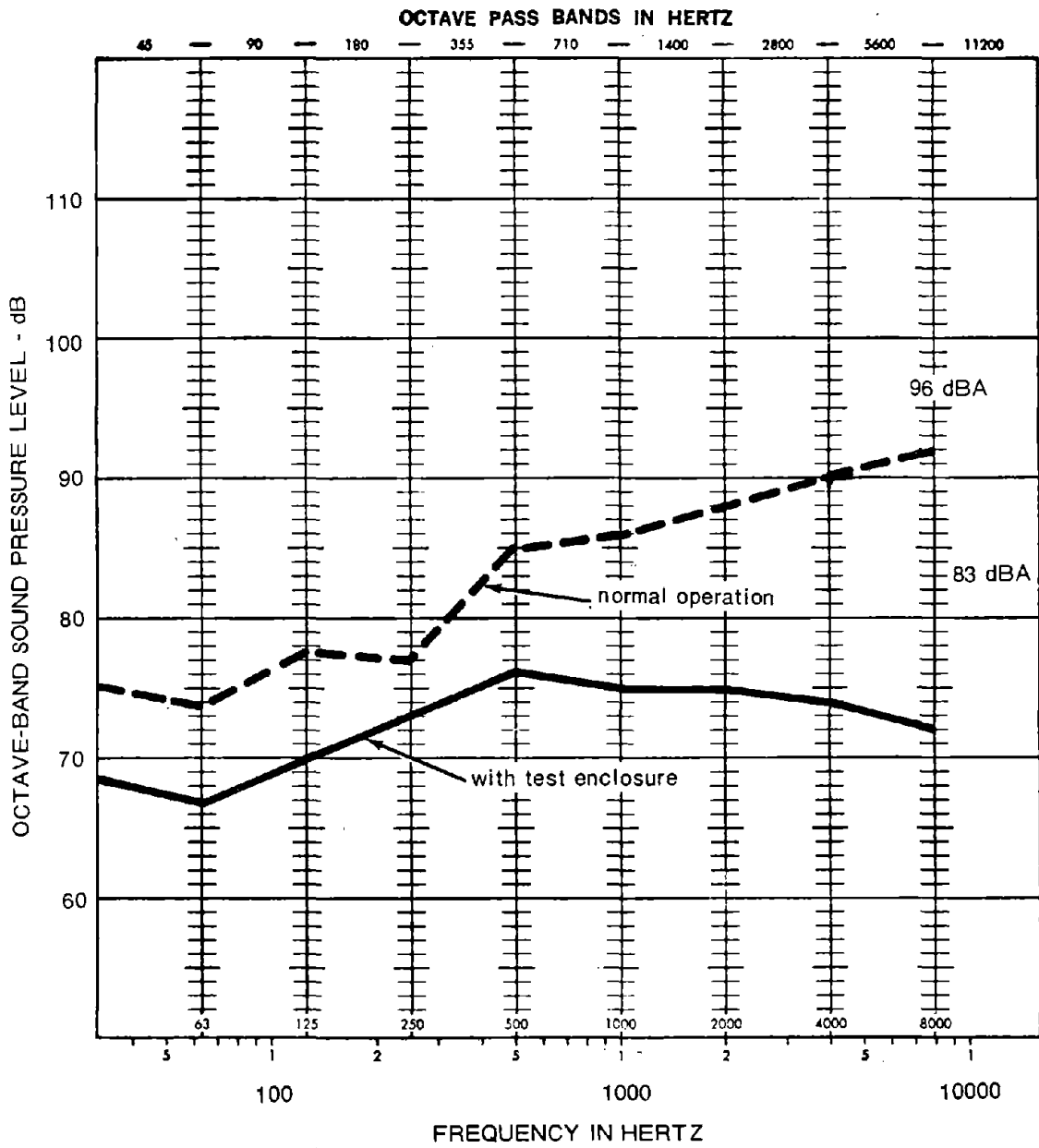

Source: Allen and Ison, 1974.

FIGURE 5.20.5 - Noise 30 inches from punch press before and after test cardboard enclosure

CASE HISTORY #21 - MATERIALS HANDLING, AIR MOTORS

Description of the Problem

Air operated motor hoists are a noise source in many industries that make extensive use of materials-handling systems.

Control Approach

As the noise source is the exhaust air, this exhaust can be muffled by using off-the-shelf mufflers selected for the air pressure and delivery of the exhaust.

Noise Reduction Achieved

A typical octave band analysis, before and after installation of an exhaust muffler, is shown in Figure 5.21.1. Note the rising spectrum that is characteristic of freely-escaping high pressure gas. Another case showed the following A-weighted sound levels at the floor for a 1-ton air hoist:

	<u>No Muffler</u>	<u>With Muffler</u>
Up - no load	98	85
Up - 600 lb	96	84
Down - no load	102	88
Down - 600 lb	100	86

Air exhaust from other tools can be similarly muffled. Newer designs include mufflers, which should be specified at purchase.

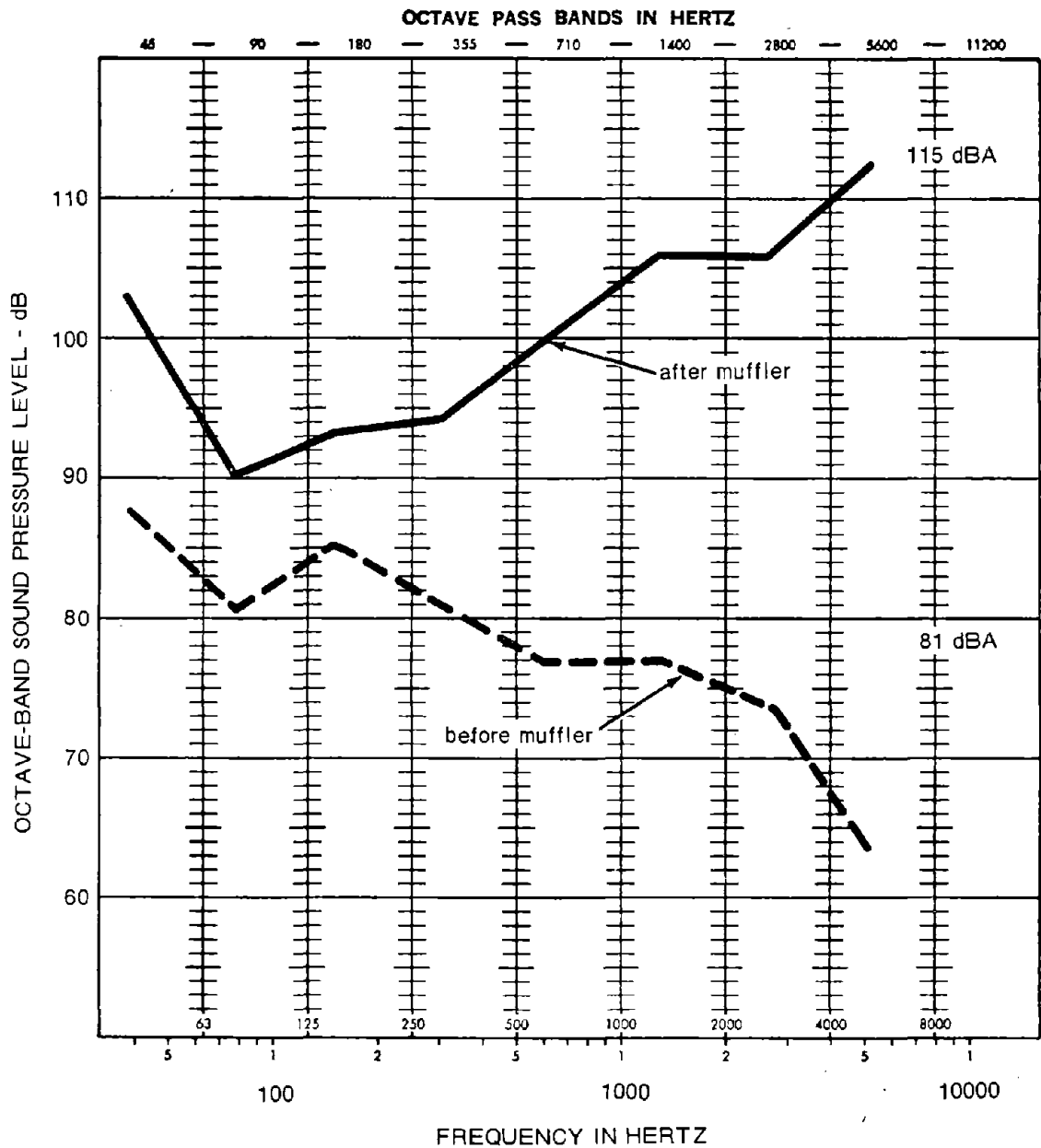

Source: AFS-Foundry Environmental Control of Noise, 1972.

FIGURE 5.21.1 - Effect of muffler on air exhaust from hoist

CASE HISTORY #22 - TEXTILE BRAIDING MACHINES*

Description of the Problem

In braiding operations, a bobbin of thread is rotated on a carrier base in a special slotted cam. This cam revolves as it is rotated around the machine, with several other carriers and cams. The carriers are thrown from one cam to another. With steel carriers, the major source of the intense noise present is the resulting metal-to-metal impact. The manufacturer was willing to consider machine modifications to reduce noise in the case history reported here.

Measurement and Analysis and Control

In a laboratory study, the metal-to-metal contact was easily identified as the chief noise source. It was recognized that a carrier with inherent damping properties should reduce the noise. Replacement of the carrier by a nonmetallic one was thus considered. Of the several materials tried, the best combinations of strength, light weight, and damping was an injection moldable polyurethane.

Noise Reduction Achieved

The carriers were installed in a 13-carrier braider operating at a handle speed of 340 rpm. With the microphone 10 inches above the top plate of the braider and 18 inches out, the levels shown in Figure 5.22.1 were obtained. A reduction of 11 dB was obtained.

The above results were obtained in the laboratory. For an in-plant test, a row of 84 braiders was converted to plastic carriers. The adjacent row was left with steel carriers; other rows of braiders were operating. The microphone was 3 feet from the centerline between the test rows, and 3 feet above the floor. The noise levels for various combinations of machines is shown below (an x indicates on).

Level, dBA	97	97	90	85
Steel test row	x	x		
Plastic test row	x		x	
All other	x	x	x	x

Residual noise from the motor cooling system remained and lowered the noise reduction to the 7 dB achieved in this production test.

* From Cudworth, A. L., and J. E. Stahl, Noise Control in the Textile Industry. Proc. Inter-Noise 72: 177, 1972.

Pitfalls

Since this study, it has been found that the plastic carriers are not strong enough for some operations requiring heavy yarn (or wire). This suggests consideration of a composite carrier with a steel core for strength and a cladding of heavy polyurethane for damping. To our knowledge, this concept has not yet been tried. This emphasizes the need for considering non-acoustical parameters along with the acoustical.

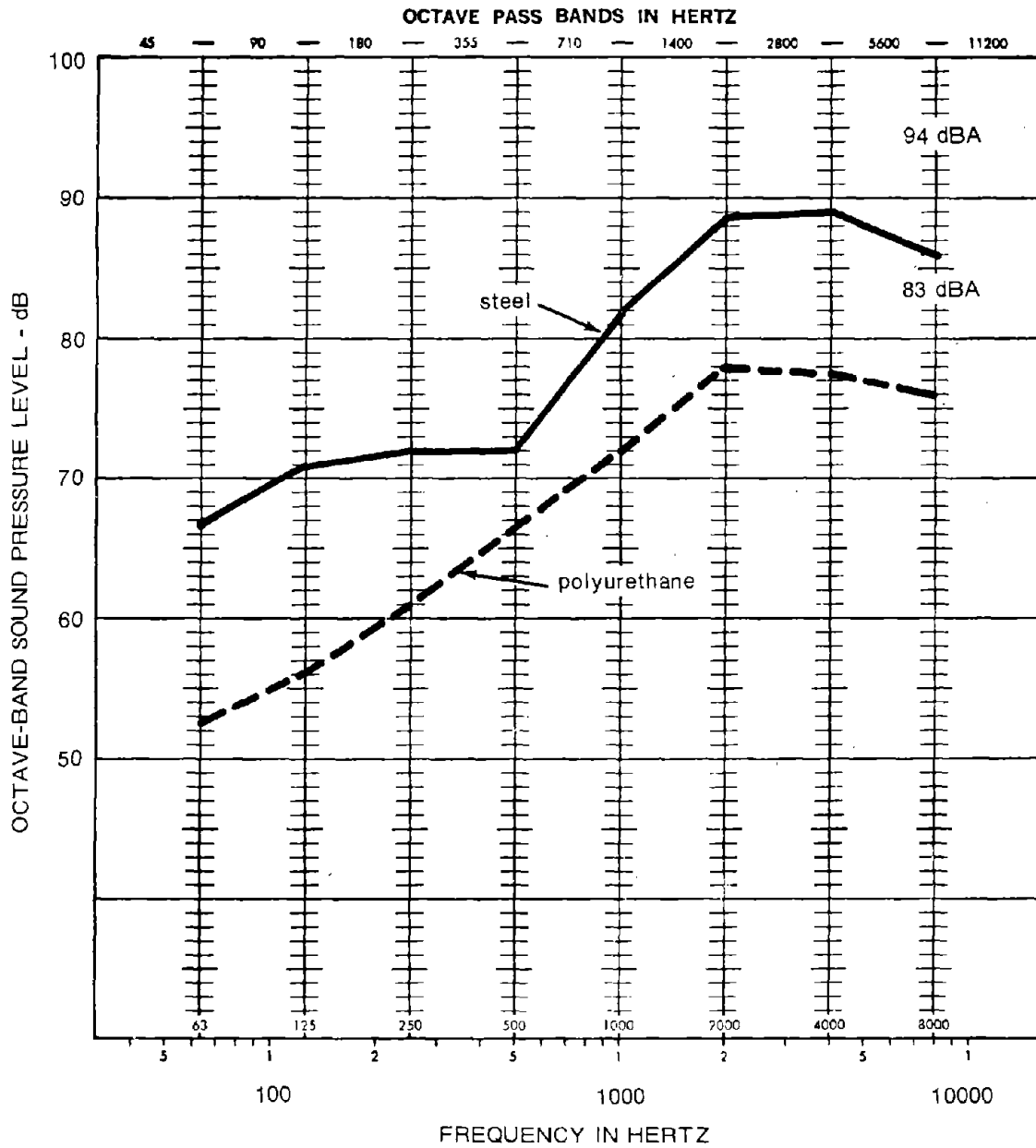

FIGURE 5.22.1 - Textile braiding machine: comparison of noise levels from steel carriers and from polyurethane carriers

CASE HISTORY #23 - METAL CUT-OFF SAW*

Description of the Problem

A common problem in industry is that of protecting workers from noise produced by machines that the worker must guide or manipulate directly. An example is a cut-off saw used on metal shapes. Noise comes from two main vibrating sources: the saw blade itself and the workpiece, which is largely unconstrained. The saw itself is actuated downward and into the work by a lever attached to the hinged and counter-balanced (or spring-loaded) saw and motor.

The worker must visually monitor the cutting operation. Also, and perhaps more importantly, the vibration and opposing force transmitted to him through the lever arm also furnish useful cues on the progress of the cutting operation. The problem is to reduce the noise he receives, without undue interference with work flow, with visibility, and with the use of the lever arm.

Control Approach Chosen

The solution was an enclosure covering the whole saw. Workpieces pass transversely through slots in the enclosure. Flaps of lead-loaded vinyl close off the opening and reduce to a small amount the unavoidable leakage area when a workpiece is present. The front, above saw bed height, is closed by two doors whose surface is mostly $\frac{1}{4}$ -inch clear plastic (polymethylmethacrylate). This plastic provides very good vision. The doors close with a gap the width of the control lever. Each door has a flap of lead-loaded vinyl about 3 inches wide to close the gap. The lever pushes aside the flaps only where it protrudes. Thus the leakage toward the worker is greatly reduced.

Noise Reduction Achieved

Figure 5.23.1 shows the spectra at the worker position before and after the enclosure was installed. The decrease in A-level is 13 dB. The standard panels used in the enclosure are very much better than indicated by the reduction measured, illustrating again the importance of leaks in determining the performance of enclosures.

Pitfalls

Several features of the design could be improved. The ears of the workers are very close to the leak at the door flaps. It should be relatively simple to offset the saw feed lever to the right (for

* Handley, J. M., Noise--The Third Pollution. IAC Bulletin 6.0011.0, 1973.

the right-handed worker). This has several advantages: (1) it places his right hand in a more comfortable position, (2) with the door gap and flaps moved to the right, his vision is greatly improved, and (3) the noise leak is moved further from his ears. A nonacoustical improvement would be to have the doors slide open, rather than open out, which can be a safety hazard.

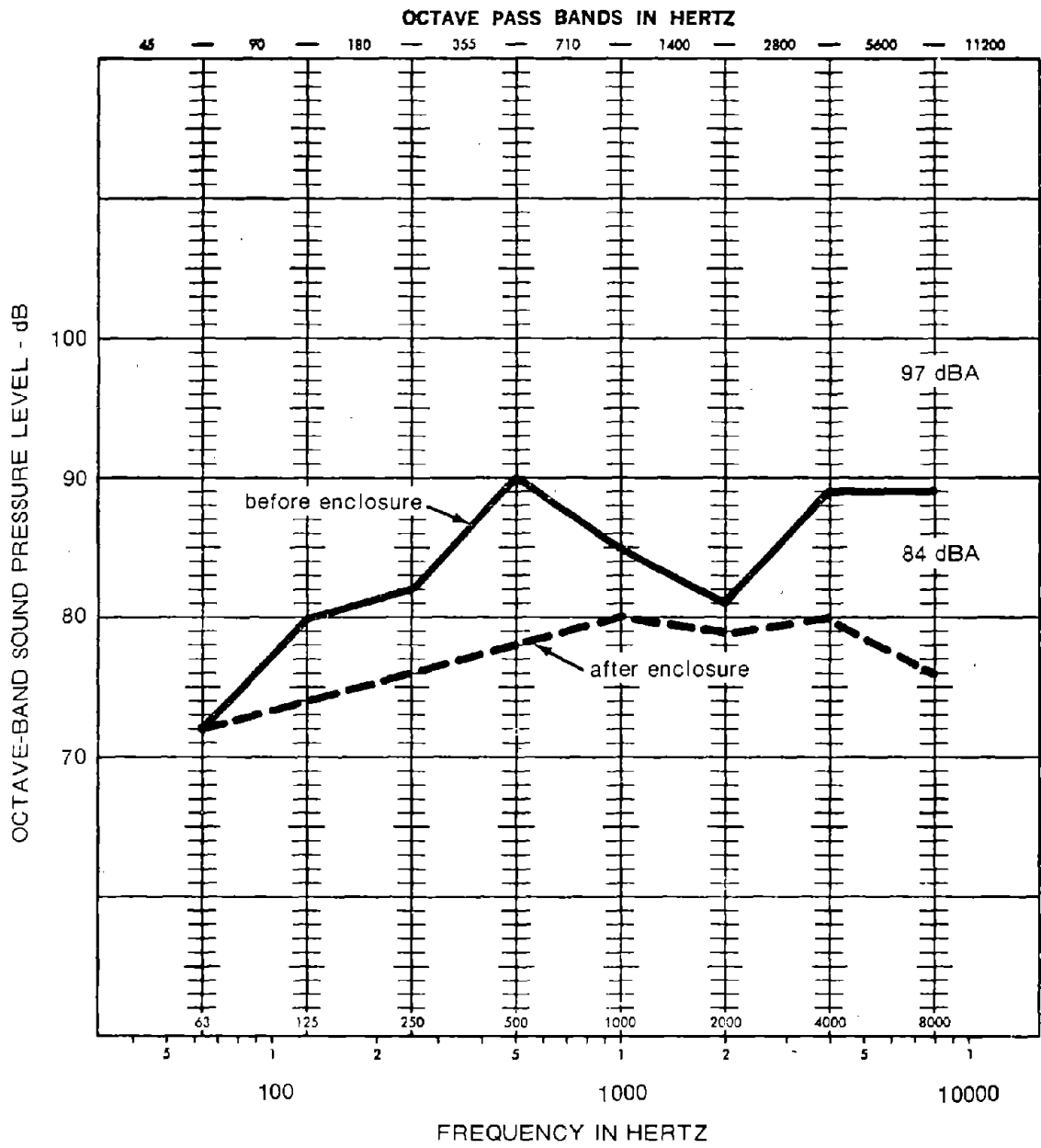

FIGURE 5.23.1 - Metal cut-off saw: operator's exposure before and after enclosure of saw

CASE HISTORY #24 - PLANER-WOOD*

Description of the Problem

Wood planers in the forest products industry produce noise levels of 102-108 dBA at the operator (feeder) work stations. Noise levels are 103 dBA at the grading station and trimmer and 95 dBA elsewhere in the planing mill.

Control Approach Chosen

In the area cited in the article, enclosures were installed on 30 large planers. Out of the general program, the following specific guidelines for viable enclosures were developed by experience.

(1) Walls and roof should be from 8 to 10 feet high, using staggered studs; thus keeping inside and outside wall independent with separate sills and headers. Isolate wall structure from floor with felt or mastic. Fill space between walls with rock wool or fiberglass. Sheathing used was 1½-inch tongue and groove or equivalent plywood. Additional acoustical board was used on upper two-thirds of walls and ceilings for noise absorption. Removable wall or roof sections should be installed as needed for major machine repairs.

(2) Floors are usually adequate as constructed for a normal planer installation, but if the planer is elevated on piers, the enclosure walls should be extended to the main floor or acoustical floor similar to the walls constructed between piers.

(3) Doors should be refrigeration type, with beveled or stepped edges. They should open out, so that suction from blowers keeps them closed. Doors or jams should be sealed with weatherstripping. Use heavy duty hinges. Alternatively, standard acoustical doors may be purchased.

(4) Windows should be as small as practical, using double-glazed shatterproof or screened glass with an air space between.

(5) Infeed and outfeed openings should be as small as possible. A tunnel type opening provides room for multiple baffles of old conveyor belting or lead-filled vinyl to block the noise path. Slit the belt at intervals to accommodate various board widths, keeping

* From Pease, D. A., Forest Industries, March 1972.

the unused portion of the tunnel width blocked. The outfeed tunnel should be at least as long as the longest boards fed through the planer so that noise caused by the vibrating board is confined inside. Install funnel-shaped metal facing inside to guide the stock into the tunnel opening.

(6) Opening for ducts and pipes should be just enough over-size to permit packing the annular space with insulation.

(7) Make-up air openings, to compensate for air exhausted by the blower system of the planer, must be constructed as a silencer to control noise leakage. Construct a chimney several feet high, with baffles arranged inside so that incoming air must follow a zig-zag path; baffles should be lined with acoustic material. Another method is a smooth-wall chimney with a "weather cap" baffle lined with acoustic material at the top.

Noise Reduction Achieved

The article states that noise levels were reduced to less than 90 dBA, to comply with OSHA regulations.

Pitfalls

At these high levels leaks are critical, and should be kept to the minimum.

The absorbent must be covered by a plastic film to avoid fouling by the dust. In addition, because lumber is not always fed in straight, the absorbent must be protected by a heavy galvanized screen.

The feed tunnels should be long enough to hold the whole board, or else there must be positive hold-down to prevent board vibration.

CASE HISTORY #25 - PUNCH PRESS TOTAL ENCLOSURE

Description of the Problem

Two Minster model P2-2000, 200-ton straightside presses were running over 250 strokes per minute in stamping out laminations for a particular motor model. The press is located in a metal-construction building. Dies are changed often.

Noise level at the operator station was 104 dBA, and the general plant level was 92 dBA.

Control Approach Chosen

Panels forming a total enclosure were constructed using:

- 1 layer absorbent polyurethane acoustical foam
- 1 layer 1/64-inch sheet lead
- 1 layer 3-inch fiberglass TIW blanket
- 1 layer fiberglass cloth to withstand industrial solvents.

The enclosure used was circular, 176-inch in diameter, 16-feet high, with top of domed construction. Access doors allow for maintenance, and there is a stock feed opening. Finished parts leave the enclosure by means of two under-floor part guides. Supply lines were rerouted under floor, using flexible conduits. A 3500 cfm heat exhaust system with a silencer was added to each dome.

The operator is outside the enclosure except to change dies, change feed reels, or make adjustments.

Noise Reduction Achieved

Total enclosures reduced noise level for operator to 83 dBA and general plant level (with other equipment) to 87 dBA.

CASE HISTORY #26 - DEWATERING VACUUM PUMP, PAPER MILL*

Description of the Problem

In paper manufacturing, a fine-grained mineral slurry is dewatered by a suction press and a vacuum pump. The mixture of air and water discharges into a drain; slugs of water make the discharge pulsate irregularly. Although no workers stay long in the discharge area, the levels are high even at considerable distances from the discharge pipe. In one instance, the pipe was inadvertently tuned to the pump pulse frequency, thus compounding the problem.

Control Approach Chosen

The solution is a special combination muffler and water/air separator called a snubber. Besides use of the snubber, the line length should be changed to detune the system.

Figure 5.26.1 shows the effect of adding a snubber and the greater effect of two snubbers. The low frequency resonances are greatly reduced by this direct scheme. A-levels close to the discharge pipe were changed from 112 dBA without snubbers to 103 dBA with one, and 93 dBA with two snubbers. Some of the low frequency reduction is probably due to the detuning effect of the change in the acoustic length that the snubbers introduce.

* Young, R. L., Practical Examples of Industrial Noise Control. Noise Control 4 (2): 11, 1958

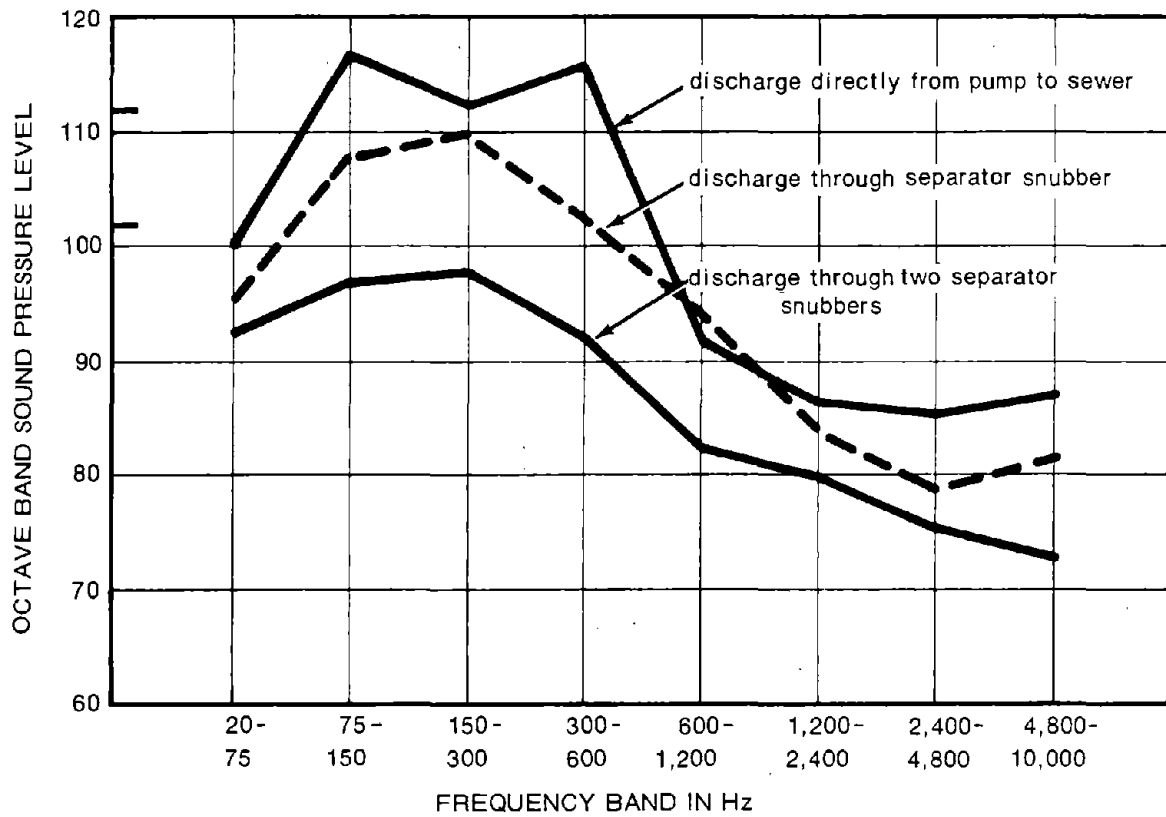

FIGURE 5.26.1 - Octave-band analysis of paper mill vacuum pump noise

CASE HISTORY #27 - STEAM LINE REGULATORS*

Description of the Problem

Steam lines with regulators are used in many industries and can be a problem noise source if they are in an area occupied by employees.

Control Approach Chosen

The method used here, which can be used to regulate other gas flows, was to modify the design of the main valve plug. The redesigned valve plug has throttling vanes, as shown in Figure 5.27.1, to reduce the turbulence of the steam flowing through the space between the regulator's main valve and its valve seat, which is the noise source.

Noise Reduction Achieved

For a 2½-inch steam line handling 50,000 lb/hr through a reduction of 555 to 100 psia, the redesigned valve reduced pipe line noise from 97 dBA to 85 dBA.

* From Electrical World, January 1973.

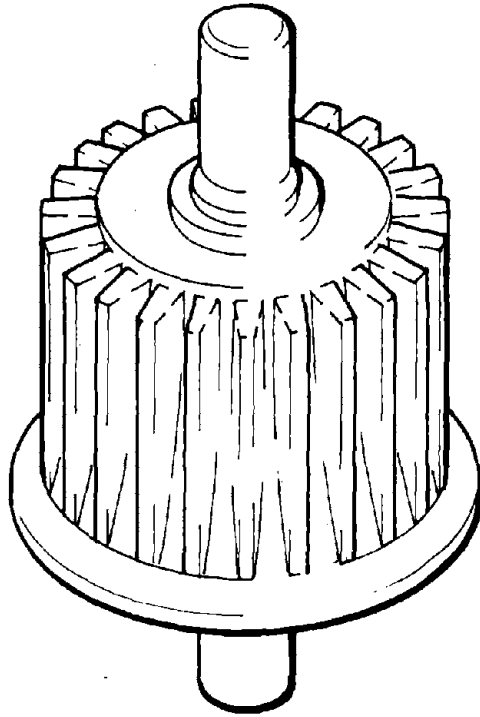

FIGURE 5.27.1 - Main valve plug with throttling vanes to reduce noise in steam line regulator

CASE HISTORY #28 - PLASTICS SCRAP GRINDER*

Description of the Problem

In the molding room, primary noise sources are from scrap grinders and plastic granulators. The noise has increased during the past few years because of the growth in number of grinders and increasing toughness of the newer plastics.

Measurement and Analysis

Noise level maxima of 125 dBA in the initial grinding phase have been recorded, and 100 dBA are common. Figure 5.28.1 shows the octave band analysis of an untreated grinder, giving the range of readings for one load of 4 pounds of polycarbonate.

Control Approach

Although the optimum mechanical conditions of the plastics scrap grinder, such as sharp blades, proper screen size, blade-to-screen clearance, and proper feeding procedures, help reduce grinder noise on existing equipment, this alone could not bring the unit within acceptable noise limits. Much of the noise came from resonant excitation of metal panels.

A damping material was applied to all surfaces: hopper, interiors of pedestals, stands, and covers. In general, a ¼-inch coating has been satisfactory for most grinders from bench models to 18 x 30-inch throat grinders.

Noise Reduction Achieved

The results of the soundproofing, shown in Figure 5.28.2 (for one load of 4 pounds of polycarbonate), bring noise levels down to OSHA criteria, reducing the maximum level from 100 dBA to a range of 88 dBA to 90 dBA.

* Morse, A. R., Plastic Technology, July 1968.

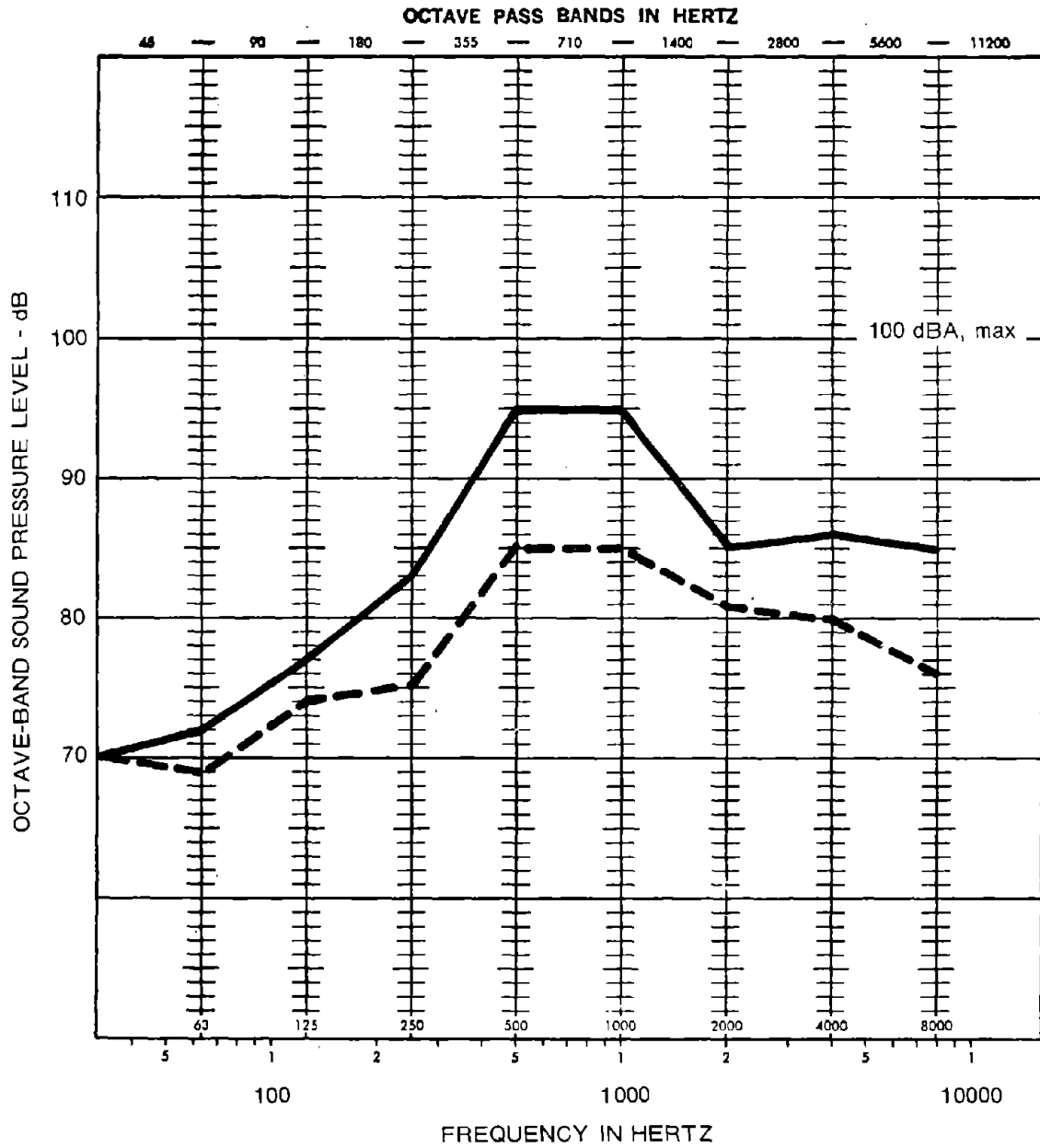

FIGURE 5.28.1 - *Plastics grinder; range of noise levels, dBA*

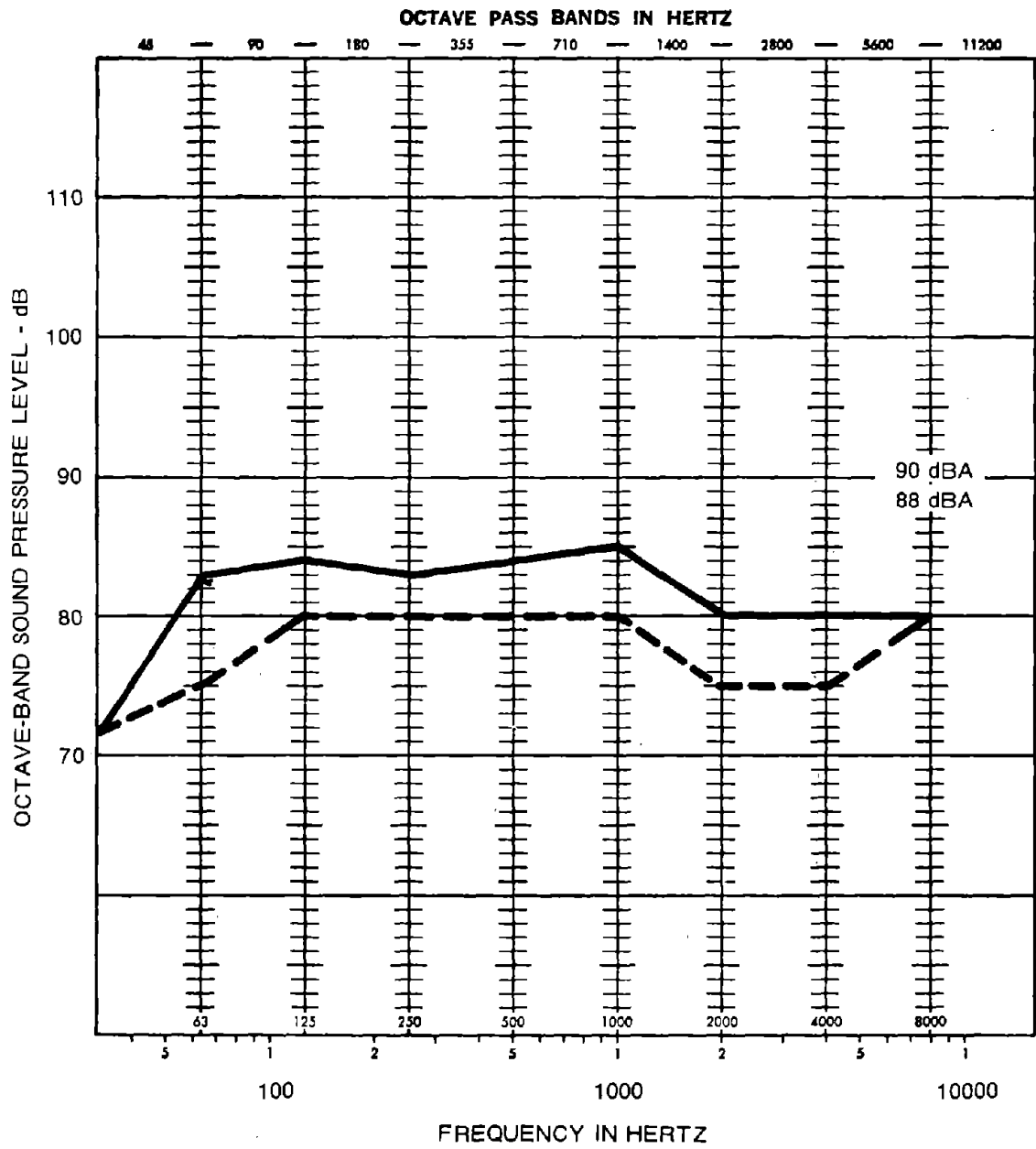

FIGURE 5.28.2 - *Plastics grinder; range of noise levels after soundproofing, dBA*

CASE HISTORY #29 - NEWSPAPER PRINTING PRESS*

Description of the Problem

This pressroom is equipped with five double 3 to 2 Hoe folders and four double 2 to 1 Hoe folders with a complement of 45 colormatic press units.

Control Approach Chosen

The following methods were used for noise reduction:

Enclosures for folders reduced noise from 111 to 101 dBA.

In the reel room, all openings in the floor or deck plates between the press room level and the reel room were sealed and isolated. The opening in the arch of the press was closed to the smallest dimension that would still allow paper to feed through to the unit. On the basis of dosimeter data, the noise exposure was reduced to acceptable levels.

On the press room floor, an existing folder enclosure was retained and improved. A control booth was constructed for noise isolation. An 8-foot wall was added on the press room floor as noise barrier, plus a 4-foot panel at the top of the wall, angled upward and toward press. Wall surfaces were lined with 2-inch absorbent polyurethane. The 8-foot wall was constructed of: 26 gauge metal, 1/8-inch masonite, 3/4-inch air space, 3/8-inch plywood, plus 26 gauge metal. The panel was 2-inch polyurethane, 1/2-inch plywood, and 26 gauge metal.

Sound traps were made at the tops of ladders at catwalk level. No isolation of the stairs, from reel room to press room, was necessary, as they are outside the press enclosures and not affected by the high noise levels of the press. Wall panels are easily removed for maintenance.

Pressmen going inside enclosure for adjustments on a short-time basis wear ear protection.

Materials used for sound absorption were flame resistant and approved by insurance inspection.

Noise Reduction Achieved

Noise levels were reduced to comply with OSHA standards.

* From Editor & Publisher, November 10, 1973.

CASE HISTORY #30 - CHEMICAL PROCESS PLANTS*

Description of the Problem

Existing chemical process plant noise reduction requires source analysis to determine the method of noise reduction.

Methods

As a result of this study, a list of noise sources is shown in Table 5.30.1, with recommended methods of noise reduction. Some specific examples and the results obtained by each noise control method are cited in Figures 5.30.1 through 5.30.4. The attenuation attained is shown in each figure.

* From Judd, S. H., Noise Abatement in Process Plants, Chemical Engineering, January 11, 1971.

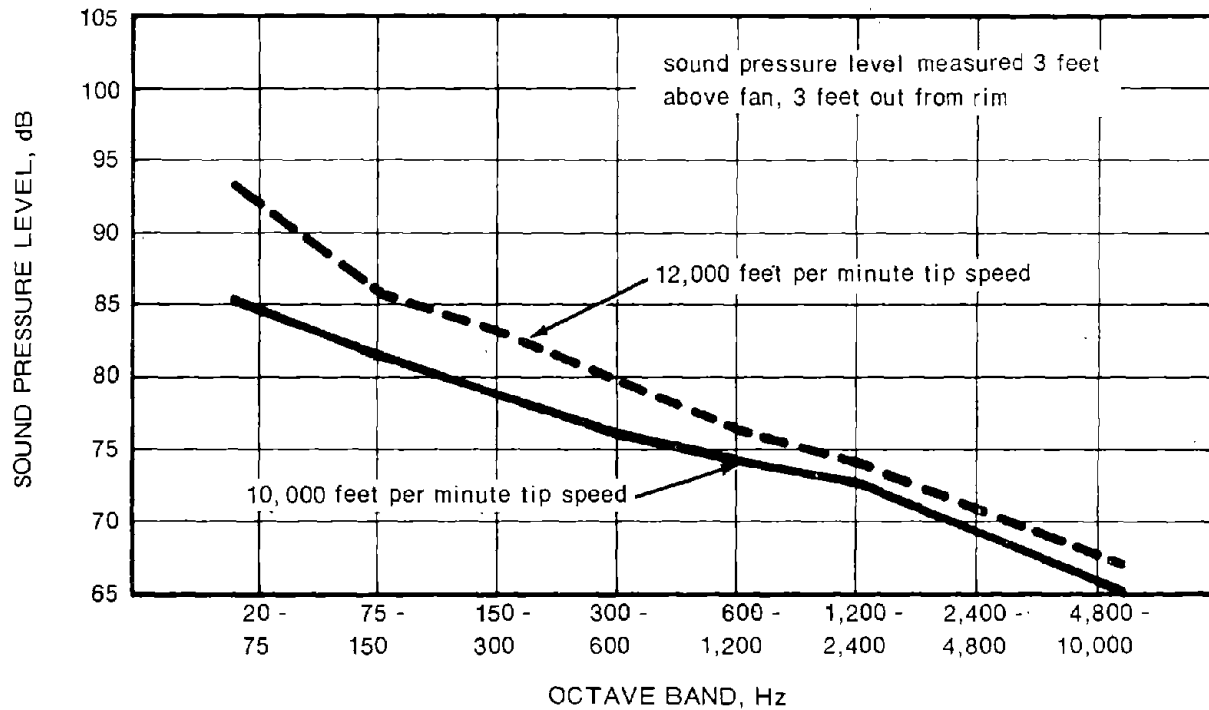

FIGURE 5.30.1 - Noise reduction achieved by reducing fan speed, using increased blade pitch to offset decrease in speed (measured 3 feet above fan, 3 feet out from rim)

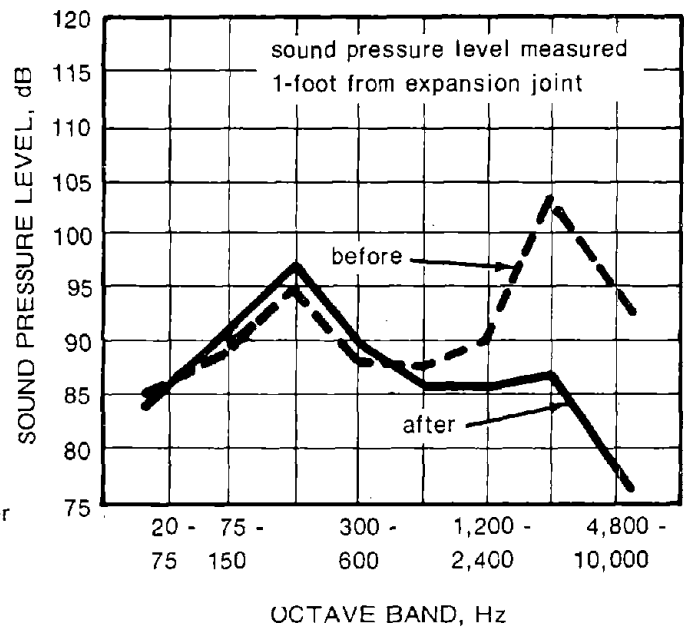
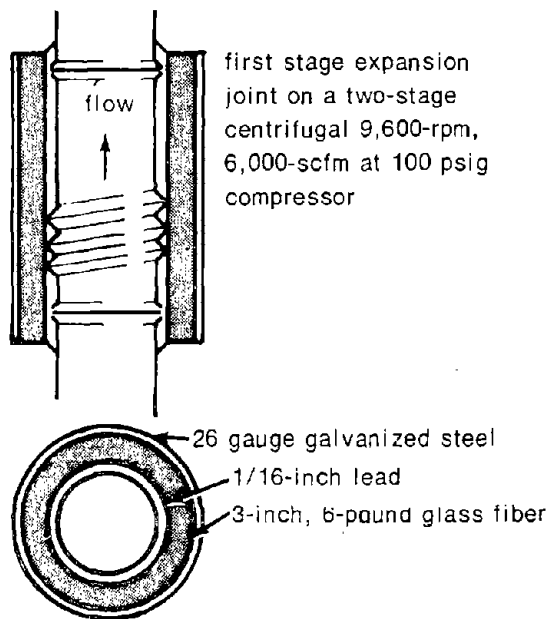
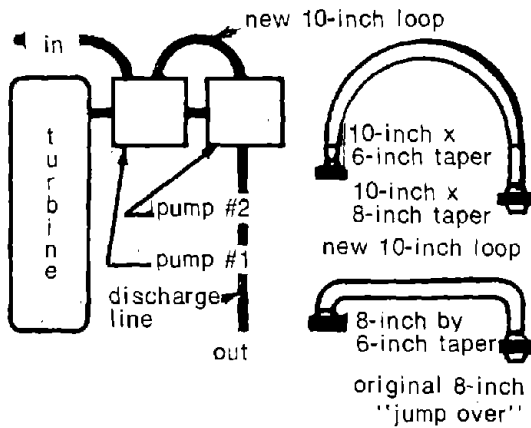

FIGURE 5.30.2 - Compressor discharge noise reduction achieved by lagging expansion joint (measured 1 foot from expansion joint)



	pump #1	pump #2
inlet psi	35	580
outlet psi	580	840
8 volute impellers	4	2
rpm	3,600	3,600
gpm	2,100	2,100

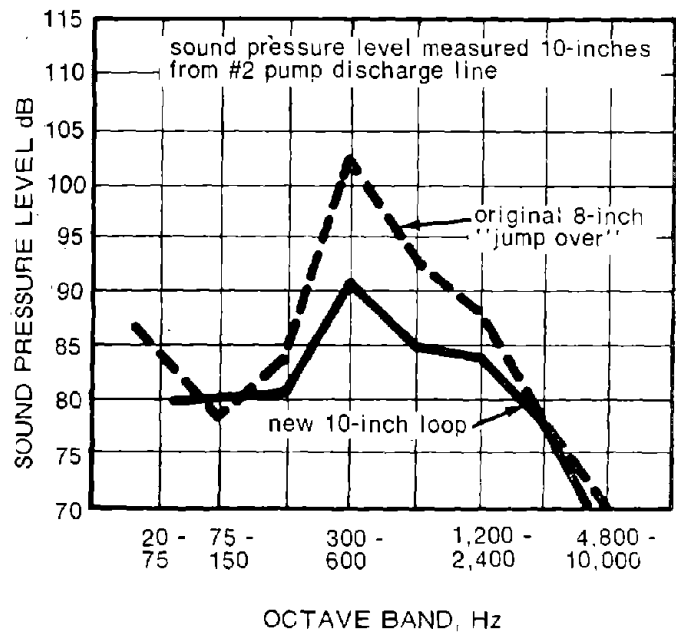

FIGURE 5.30.3 - Noise reduction achieved by redesigning pump by-pass loop (measured 10 inches from #2 pump discharge line)

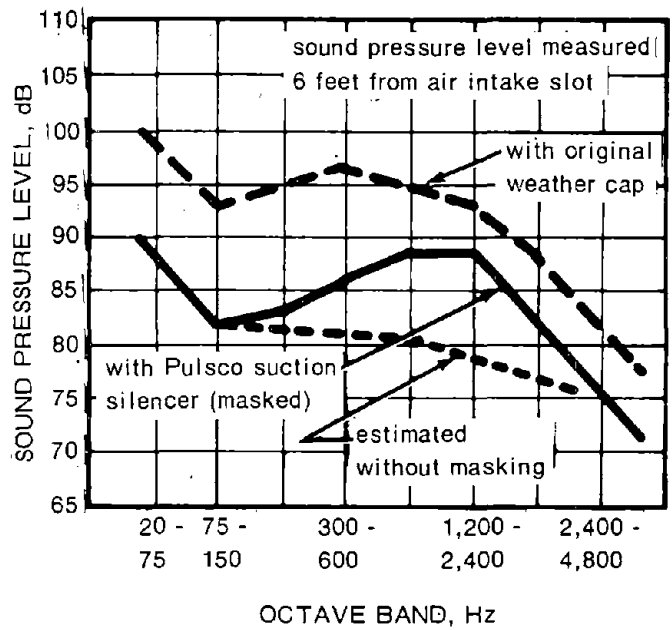
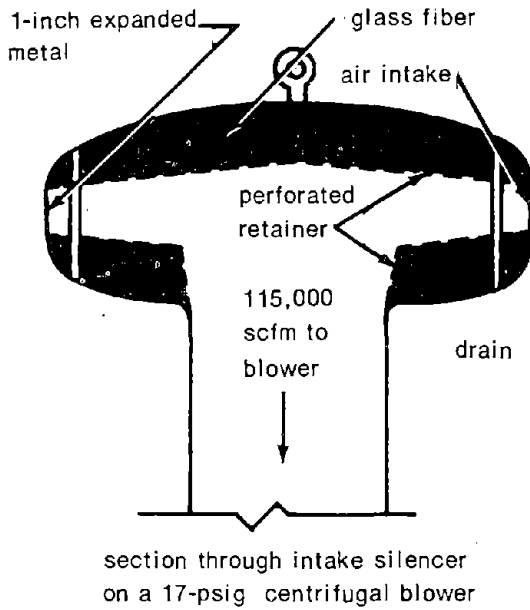

FIGURE 5.30.4 - Noise reduction achieved by adding silencer to air blower intake (measured 6 feet from air intake slot)

TABLE 5.30.1 - Sources of noise and methods of noise reduction

Equipment	Source of noise	Method of noise reduction
Heaters	Combustion at burners Inspiration of premix air at burners Draft fans Ducts	Acoustic plenum* (10 Bwg. plate) Seals around control rods and over sight holes Inspiring intake silencer Intake silencer or acoustic plenum Lagging
Motors	TEFC cooling air fan WP II cooling system Mechanical and electrical	Intake silencer Unidirectional fan Absorbent duct liners Enclosure
Airfin coolers	Fan Speed changer Motors Fan shroud	Decrease rpm (increasing pitch) Tip and hub seals Increase number of blades** Decrease static pressure drop** Add more fin tubes** Belts in place of gears Quiet motor Slower motor Streamline airflow Stiffening and damping (reducing vibration)
Compressors	Discharge piping and expansion joint Antisurge bypass Intake piping and suction drum Air intake Discharge to air Timing gears (axial) Speed changers	Inline silencer and/or lagging Use quiet valves and enlarge and streamline piping** Lag valves and piping Inline silencers Lagging Silencer Silencer Enclosure (or constrained damping on case) Silencers on discharge and lagging Enclosure (or constrained damping on case)
Engines	Exhaust Air intake Cooling fan	Silencer (muffler) Silencer Enclose intake or discharge or both Use quieter fan
Miscellaneous	Turbine steam discharge Air and steam vents Eductors Piping Valves Pumps	Silencer Silencer Use quiet valve Lagging Limit velocities Avoid abrupt changes in size and direction Lagging Limit pressure drops and velocities Limit mass flow Use constant velocity or other quiet valve Divide pressure drop Size adequately for total flow Size for control range Enclosure

*If oil fired, provide for drainage of oil leaks and inspection.
** Usually limited to replacement or new facilities.

Chapter 6

SELECTING AND USING A CONSULTANT

Knowing When a Consultant is Needed

Having read the previous chapters, you will already have a good feeling for the situations that you can deal with on your own. If you are still unsure of the solution or if preliminary measures have proved unsatisfactory, it may be time to consider the use of a consultant.

Situations where a consultant is needed arise when the machine to be quieted is complex, as when there are present many noise sources of approximately equal strength. Locating the sources and obtaining their relative noise strengths will need perhaps more sophisticated equipment and procedures than you may have. If you find that the A-level at all points at a constant distance from the machine (but within the critical distance) covers a range of 5 dB or less, this is likely to be the case.

You may also need a consultant if unusual situations exist. A common one with belt-driven blowers, for example, is a slow but considerable variation in level. Another is impact noise, as from a punch press, where several events take place in rapid succession. A narrow-band analysis of a tape recording is usually called for. Inadvertent tuning of some part of the machine may lead to pure tone ringing that is difficult to locate. For such situations, using a consultant is often the most rapid way of getting results.

If you have installed noise control means that don't work, you may (albeit reluctantly) have to use a consultant to retrieve the situation. Although this may be a painful decision, it will usually occur but once. You should document the situation thoroughly and use the consultant to supply information on what went wrong.

Sometimes you may be approaching a lawsuit situation, where data must be obtained and presented (as an expert witness) by a disinterested third party. Many consultants can provide this complete service.

Now that you have decided to obtain a consultant, how do you proceed? You should first be warned that there is no legal bar to anyone offering services as an acoustical consultant. Consequently, it is up to you to avoid those who are unsuitable because of lack of training or experience, as well as simple venality or greed.

Preceding page blank

Selection of a Consultant

People billing themselves as consultants can be broadly classified according to whether or not they have a special interest in recommending a particular acoustical product or solution. Both types, properly used, have their special advantages and disadvantages.

In the former group of "special interest consultants", individuals vary in their backgrounds from product salesmen to professionals who are quite capable in their line of business. This group, which is most commonly indicated by the degree of their association with manufacturing or retail sales of acoustical products, should be used directly only if, by use of the techniques described in previous chapters, you have satisfied yourself that their solution is applicable to your problem. In this case you have progressed to the point where the "consulting" aspect consists mainly in soliciting proposals for design and installation. The main problem remaining is to write your contract in such a way that you are guaranteed (to the extent possible) of actually solving your problem in a cost effective manner. The advantage of using this group directly is that you avoid consultant costs and pay for the product. In effect you are acting as your own consultant.

The disadvantage in dealing with a product-oriented consultant is that a costly mistake, out of proportion to the independent consultant's fees, is rendered more likely. Examples abound of cases in which thousands of dollars were spent in implementing a particular solution, only to find that no good was done. (A common mistake is to utilize acoustical tile in situations where reverberant noise is not the problem.) If there are any doubts in your mind as to the proper method for solving your problem, then an "independent consultant" (one free from ties to a particular line of products) should be called in. Since this "independent consultant" is what is usually meant by the word "consultant", it is this type of professional that will be discussed for the remainder of this chapter. The word independent will be dropped.

In choosing a consultant a first step is to inquire of the two organizations in the field that are interested in the qualifications of their members. The most inclusive is the Institute of Noise Control Engineering (INCE), P. O. Box 1758, Poughkeepsie, New York 12601. This group will have as members only those who have passed suitable examinations. Applicants must pass both the Engineer-in-Training examination given for registered professional engineers and a special examination on noise control engineering that was first given in 1974. There will be no grandfathering - the term applied to certification purely on the basis of past activity in the field. It is expected that this certification of noise control

engineers will receive approval by and support from the governmental agencies needing such engineers directly, or in the contract work they support.

The second source of information on qualified acoustical consultants is the National Council of Acoustical Consultants (NCAC), 8811 Colesville Road, Suite 225, Silver Spring, Maryland 10910. This group has a rigorous code of ethics requiring (as with all registered professional engineers) that no member be associated with the sale of a product. Consequently some consultants, otherwise well qualified, are not members because of this association. A membership list is available. Not all the completely classified consultants are yet members.

At the present writing, INCE certification is just beginning and the NCAC list is not yet complete. Therefore the most common recourse is to question the prospective consultant yourself. A series of questions is given below. These questions are rather completely presented here, and you may wish to ask only those that are pertinent to your particular task.

Guideline Questions

Education

- (1) What schools did you attend?
- (2) What courses did you take bearing on acoustics?
- (3) What degrees did you receive? When?
- (4) In what special conferences, seminars, symposia, or graduate courses in acoustics have you been involved, either as a student or as an instructor?

Experience

- (1) For how many years have you been professionally active in acoustics?
- (2) Please supply a list of recent clients that you have served, preferably in my geographical area, and on problems similar to those in which I am interested.
- (3) What teaching or training have you done in acoustics, and to what groups--university, industry, trade associations, civic groups, engineers, symposia?

Status

- (1) Are you now an independent consultant? For how many years? Full time or part time?
- (2) If part time:
 - (2.1) Who is your chief employer or in what other business ventures are you involved?
 - (2.2) Is your employer aware and does he approve of your part time activity as an acoustical consultant?
 - (2.3) May we contact your employer concerning you?
 - (2.4) What restrictions does your employer place on you as a part time acoustical consultant?
- (3) Are you associated with the manufacture or sale of a product that could create a conflict of interest in your activities as an acoustical consultant?

Professional Affiliations

- (1) Of what engineering or scientific societies or associations are you a member? Representative ones are the Acoustical Society of America, the Institute of Noise Control Engineering, and the National Council of Acoustical Consultants.
- (2) What is your present grade of membership and length of time in that grade, for each association?
- (3) Have you been accorded any professional honors in these associations such as offices, committee chairmanships, awards, or prizes?
- (4) Are you a registered professional engineer? In what states? In what disciplines?
- (5) Of what professional engineer associations are you or your firm a member?
- (6) Of what trade associations, chambers of commerce, or similar business groups are you or your firm a member?

Special Capabilities

- (1) In what areas of acoustics do you specialize?

Noise measurement and control
Architectural acoustics
Hearing conservation
Shock and vibration measurement and control
Nondestructive testing
Medical ultrasonics
Underwater acoustics

- (2) What equipment do you have for conducting acoustical measurements in the field? In the laboratory?
- (3) With what national standards do you comply in conducting your acoustical measurements?
- (4) Are you listed by any governmental or trade association body as an acceptable or certified acoustical test laboratory?
- (5) What equipment do you have for the absolute calibration of test apparatus?
- (6) Can you serve as an expert witness, either for your client or as a friend of the court? What experience have you had?

Business Practices

- (1) Please indicate your fee structure. Do you handle this by hourly charges, estimates for total job, retainer charges, or all of these? (1974 hourly fees vary from \$30 to \$60, depending on the experience and training of the consultant.)
- (2) If you use a contract form, please supply a sample.
- (3) In your charges, how do you treat such expenses as travel, subsistence, shipping, report reproduction, and computer time? Consultants usually charge to you the time spent during travel for you on Monday through Friday, 8:00 a.m. to 5:00 p.m. There may be a charge for use of highly specialized and expensive equipment.
- (4) What insurance and bonding do you have?

- (5) Are you operating as an individual, partnership, or corporation?
- (6) What statements do you have in your contracts covering commercial security, liability, patent rights?
- (7) What restriction is there on the use of your name in our reports, in litigation, in advertisements?
- (8) What is the character and extent of reports that you prepare?
- (9) What facilities do you have for producing design shop drawings on devices that you may develop for the specific purposes of a consulting task?
- (10) Do you have branch offices? Where?
- (11) What size is your staff? What are their qualifications? Who will be working on this project?

The Proposal

Once you have selected a consultant, you can arrange to obtain his services in several ways. With most professional people, a verbal commitment is sometimes all that is necessary. However, you may wish to request a written proposal that spells out the steps to be taken in the solution of your problem.

Often, in a larger job, proposals from several points of view are evaluated and used as one of the bases for the final selection of the consultant. In this case answers to pertinent questions in the preceding section may be sought in the proposal rather than in the interview. If so, evaluation of the proposal from this point of view is self-evident from the above discussion. If the questions you are interested in are not answered to your satisfaction, don't hesitate to ask for further clarification. In the discussion below, we are concerned with the section of the proposal that outlines the consultant's approach to your problem.

Aside from background qualifications of the consultant, the proposal should answer the questions:

- (1) How much is the service going to cost? Smaller jobs are often bid on an hourly basis, with a minimum commonly specified of one-half day's work, plus direct expenses. Larger jobs are usually bid at a fixed amount, based on the work steps described.

- (2) What is the consultant going to do? The answer to this question may range all the way from a simple agreement to study the problem to a comprehensive step-by-step plan to solve it.
- (3) What will be the end result? The answer to this question is all too often not clearly understood; the result is usually a report that specifies the consultant's recommendation. If you do not want to pay for the preparation of a written report, and a verbal one will do, specify this in advance. Since recommendations often call for construction to be carried out by others, whose work is not subject to the consultant's control, results can usually not be guaranteed. Rather, an estimate of the noise reduction to be attained is all that can be expected. If the consultant is to provide drawings from which the contractor will work, one must specify sketches or finished drawings. Generally, sketches are sufficient. If special materials are required, the consultant should agree to specify alternative selections if possible. If you want a guaranteed result, experimental work will usually be necessary.

In the case of a proposal to quiet machine noise, the proposal, if detailed, will probably call out the following steps:

- (1) Determine the daily noise dose, so that the amount of reduction required is known.
- (2) From diagnostic measurements, determine the location and relative strength of the major noise sources on the machine in question, all other competing noise sources being more than 10 dB below the intended noise.
- (3) Design preliminary noise control means; discuss design with production people for possible interference with access to the machine.
- (4) Prepare and submit final recommendations in a report, with construction data.
- (5) In a post-report conference, resolve any questions or compromises; submit memorandum of conference.
- (6) If experimental work is needed, it can be added between (3) and (4) above.

Other Services

If you wish, the consultant can also, as additional services, provide monitoring of construction to determine compliance with specifications. The consultant can also make post-installation measurements to confirm predictions and supply oral briefings as needed.

By working with the consultant during his measurements, you can learn a great deal about how to handle the special situation for which he has been retained. However, he brings to the job an instrument that is most difficult to reproduce: ears trained to listen and to guide the use of the physical instruments. It takes much practice and not a little aptitude to achieve this condition. This aspect of a consultant's expertise is most difficult to replace.

If the consultant is to serve as an expert witness for you, you will find that he is not automatically on your side. Rather, he is more like a friend of the court, devoted to bringing out the facts he has developed, with careful separation of fact from expert opinion. Complete frankness is needed if you want to avoid unpleasant surprises. For example, the consultant may be asked by the opposing attorney for a copy of his report to you. Thus, this report should be prepared with this eventuality in mind.

If the consultant is retained to develop a quieter machine for you, there should be a meeting of minds on handling of patent rights. Ordinarily the patent is assigned to the client, with perhaps a royalty arrangement for the inventor.

For many situations the consultant will need photographs and plans of machines and shop layout to facilitate his evaluation. Permission to obtain these data can be handled in a manner consistent with your industrial security system. A qualified consultant will not have to be told to regard this materials as private, not to be divulged to others without your prior consent. If you regard him as the professional person he is, your association can be fruitful to all concerned.

Chapter 7

ANNOTATED REFERENCES

- B.1 American Industrial Hygiene Association. Industrial Noise Manual, Second Edition. Detroit, MI, American Industrial Hygiene Association, 1966. 171 p. Although the instrument section is outdated, the described measurement techniques are still applicable. Much data are given on ear plugs and muffs. The chapter on engineering control is very practical; it is copiously illustrated and describes many useful techniques. A most valuable section on examples presents compact, illustrated case histories in which the noise reduction obtained is given, usually with octave band spectra.
- B.2 American Foundrymen's Society. Control of Noise, Third Edition. Des Plaines, IL, American Foundrymen's Society, 1972. 67 p. The engineering section of this manual was prepared by an experienced consultant. It is written without equations, but with many charts, graphs, and tables. Although the many examples are taken from foundry technology, the control techniques are quite general in application. There are many compact case histories, together with data on the noise reductions obtained. The point of view is very practical.
- B.3 American Petroleum Institute. Guidelines to Noise. American Petroleum Institute. Washington, DC. Medical Research Report EA 7301. 1973. 111 p. This commissioned report summarizes measurement instruments and procedures, explicit noise reduction techniques, new plant design for low noise, and source characteristics. The appendices have detailed information on noise control materials, levels from machinery, and addresses of suppliers of noise control materials.
- B.4 Bell, L. H. Fundamentals of Industrial Noise Control. Trumbull, CT, Harmony Publications, 1973. 250 p. This practical book is written from the point of view of the practicing noise control engineer/consultant. A minimum amount of mathematics is used; many examples and exercises are given. The chapters on enclosures, fans, gears, silencers, and vibration control are quite useful. A feature of the book is the compact case histories, for which photographs and drawings amply describe the techniques used.
- B.5 Beranek, L. L. (ed.). Noise and Vibration Control. New York, NY, McGraw-Hill, 1971. 630 p. This is the major modern reference source for the noise control engineer. The treatment is often mathematical, but there are plenty of illustrative worked-out problems. Especially useful are the treatments of

transmission loss of simple and complex panels; mufflers and silencers; sound in rooms; vibration isolation; and sound power measurement.

- B.6 Diehl, G. M. Machinery Acoustics. New York, NY, John Wiley & Sons, 1973. 204 p. The chief contribution of this book is in a detailed description of practical techniques, backed by analysis, for the in situ measurements required for calculating sound power. Every professional noise control engineer should be aware of these techniques. The sections on noise sources and reduction procedures have a great deal of directly useful information, especially for enclosure design.
- B.7 Harris, C. M. (ed.). Handbook of Noise Control. New York, NY, McGraw-Hill, 1957. 985 p. Although old, this is still the fundamental reference handbook for the noise control engineer. Of particular interest are these sections: 13, vibration isolation; 14, vibration damping; 21, acoustical filters and mufflers; 23, gear noise; 24, bearing noise; 25, fan noise; 26, noise in water and steam systems; 27, heating and ventilating system noise; and 30, electric motor and generator noise. Of course, recent developments in acoustical materials and measuring equipment are missing, but the fundamentals are unchanged.
- B.8 King, A. J. The Measurement and Suppression of Noise. London, Chapman and Hall, 1965. 180 p. This British book is devoted chiefly to noise from electrical machinery. Much attention is paid to the design of duct silencers.
- B.9 Peterson, A.P.G., and E. E. Gross. Handbook of Noise Measurement. General Radio Co., 1972. 317 p. This is an excellent source of data on measurement of sound pressure and calculation of sound power levels. Valuable details are given on sound analysis techniques, characteristics of many types of acoustical instruments, and a summary of noise reduction procedures. An especially useful section covers precautions to be observed to ensure that valid data are acquired.
- B.10 Noise and Its Control. Pollution Engineering Magazine. Reprint of articles, 1973. This very readable set of articles summarizes characteristics of machine noise sources and noise control techniques. It will provide a general background to the problems.
- B.11 Thumann, A., and R. K. Miller. Secrets of Noise Control. Atlanta, Fairmont Press, 1974. 256 p. This book presents much practical noise control information in graphs and tables, with a minimum of mathematics. Especially useful are data on cost estimating, a listing of suppliers of noise control products, means of source location, silencers, and check lists for management of noise control. There are many useful worked-out problems. A comprehensive list is supplied for all the standard methods of measurement that a professional noise control engineer should use.

- B.12 Yerges, L. F. Sound, Noise and Vibration Control. New York, NY, 1969. Van Nostrand Reinhold, 1969. 203 p. This practical book has practically no mathematics and relies almost completely on tables, charts, and graphs for its data. The author, an experienced acoustical consultant, provided a great deal of directly useful information on materials selection, noise characteristics of machinery, design of noise control means, and translation of subjective reactions to noise into causes and solutions.

Periodical References, Arranged by Topic

P.1 Absorber, resonant

- Mikeska, E. E., and R. N. Lane. Measured Absorption Characteristics of Resonant Absorbers Employing Perforated Panel Facings. J. Acoust. Soc. Am. 28: 987, September 1956. Gives results for many different configurations, tuning from 100 to 800 Hz.

P.2 Air moving equipment - general

- American Society of Heating, Air-Conditioning and Refrigerating Engineers Handbook. Chapter 33, "Sound and Vibration," 1970. The definitive treatment of air conditioning noise.
- Diehl, G. M. Think Quiet. Compressed Air Magazine. Reprint of set of articles, 1971. This is a forerunner of the author's book on machinery noise. The emphasis is on air moving machinery.
- Kodaras, M. J. Suppression of Ventilating Noise. Noise Control. 2, (2): 42 (1958). Treatment of ducts, mechanical rooms.
- Sanders, G. Noise Control in Air-Handling Systems. Sound/Vibration. 1 (2): 8, February 1967. Descriptive. Covers concepts of noise control in air conditioning, cooling towers, gas turbines, blowers, internal combustion engines, jet engines.

P.3 Brewing

- Melling, T. H. Noise in the Brewing Industry--the Sources, Its Control. Proc. Inter-Noise 72: 313 (1972). Describes bottling and keg line noise. Few data on control.

P.4 Compressor

- Diehl, G. M. Stationary and Portable Air Compressors. Proc. Inter-Noise 72: 154 (1972). The chief noise sources are discussed thoroughly, and a few noise control suggestions are offered.

P.5 Cooling tower

- Dyer, I., and L. N. Miller. Cooling Tower Noise. Noise Control. 5 (3): 44, May 1959. Most of noise from fans. Estimation procedures given. No noise control suggestions.
- Seelbach, H., Jr., and F. M. Oran. What to do About Cooling-Tower Noise. Sound. 2 (5): 32, September-October 1963. Describes characteristics of the noise, gives a detailed estimating procedure, and describes effect of intake and discharge silencers.

P.6 Damping

- Miles, R. C. Steel-Viscoelastic Composites. Sound/Vibration. 7 (7): 27, July 1973. Describes a panel of two layers of steel bonded by a lossy adhesive. Excellent damping is obtained.
- Warnaka, G. E., et al. Structural Damping as a Technique for Industrial Noise Control. Reprint from J. Am. Indus. Hyg. Assn., January 1972. Comparison of noise radiated from damped and undamped machine surfaces.

P.7 Diagnosis: locating sources

- Baade, P. K. Identification of Noise Sources. Proc. Inter-Noise 72 Tutorials, p. 98 (1972). Valuable and practical information on techniques for locating noise sources.
- Gilbrech, D. A., and R. C. Binder. Portable Instrument for Locating Noise Sources in Mechanical Equipment. J. Acous. Soc. Am. 30: 842, September 1958. Two microphones correlated by a multiplier allow the direction of a sound source to be found.
- Hodgson, T. H., and C. E. Ebbing. Diagnostic Tests for Locating Noise Source. Proc. Noise-Con 73: 266 (1973). Describes use of critical listening, noise contours, close-in measurements, sound power estimating, vibration measurements, time domain event analysis, cross-correlation, and coherence measurement. Many illustrations, references.
- Miller, T. D. Machine Noise Analysis and Reduction. Sound/Vibration. 1 (3): 8, March 1967. Uses rotational periodicity to locate sources in bearings, electrical equipment, fans. Briefly considers control means.
- Porter, M. A., and J. Q. Delap. Discrete Source Identification in the Presence of High Ambient Noise Levels. Proc. Inter-Noise 72: 409 (1972). Uses damped, absorbent-lined tube in front of sound level meter to reduce pickup of undesired sound for close-in measurements.

P.8 Enclosures, panels

- Nordby, K. S. Attenuation of Non-Metallic Panels. Proc. Inter-Noise 72: 127 (1972). For moderate amounts of transmission loss, light weight panels can suffice. Paper describes characteristics of plastics, foams, aluminum, safety glass.

P.9 Fans

- Carrier. Sound and the Centrifugal Fan. 1969. This engineering guide provides alignment charts for estimating octave band levels from centrifugal fans.
- Graham, J. B. Acoustical Considerations for the Selection of Fans for New Facilities. Proc. Noise-Con 73: 343 (1973). Gives data on effect on noise of fan type, variable inlet vanes, blade angle, and operating point on fan characteristics.

P.10 Gas turbine

- Tatge, R. B. Noise Control of Gas Turbine Power Plants. Sound/Vibration. 7 (6): 23, June 1973. Defines NEMA noise limit curves, noise reduction for regenerator equipment, use of silencers.

P.11 Gears

- Dunlap, T. A., and W. G. Halvorsen. Transmission Noise Reduction. SAE Paper 720735. September 1972. Discusses measurements of bending and torsional compliance, and noise reduction by detuning drive train components, decoupling housing areas, and housing damping.
- Route, W. D. Gear Design for Noise Reduction. SAE Paper 208E. June 1960. Discusses influence of contact ratio, pressure angle, angles of recess and approach, dimension control of mounting, and tooth errors.

P.12 General

- Crocker, M. J. Noise Control Approaches. Proc. Inter-Noise 72 Tutorial, p. 17 (1972). Excellent summary of procedures.
- Cudworth, A. L. Field and Laboratory Examples of Industrial Noise Control. Noise Control. 5 (1): 39, January 1959. Case histories on ejector chutes, tote boxes, chipping hammer, air nozzles, and air compressors.
- Engstrom, J. R. Noise Reduction by Covers. Noise Control. 1 (2): 19, March 1955. Case histories on multislide punch press, riveting machine.
- Engstrom, J. R. Riveting Hammer and Paper Shredder. Noise Control. 2 (2): 18, March 1956. Case histories on riveting hammer, paper shredder.
- Handley, J. M. Noise--The Third Pollution. IAC Bulletin 6.0011.0, 1973. Case histories from Industrial Acoustics on cut-off saw, looms, punch press, power transformer, process steamboiler.
- Ihde, W. M. The Application of Engineering Noise Control Measures. National Safety News. 107 (6): 85, June 1973. This article provides an intensely practical summary of characteristics of a wide variety of noise sources and of procedures for noise control. There are many illustrations and examples.

- Yerges, L. F. Methods of Noise Control for Machinery Already Installed. Proc. Noise-Con 73: 376 (1973). Excellent and compact summary of procedures, costs. Case histories on grinders, automatic screw machines.
 - Young, R. L. Practical Examples of Industrial Noise Control. Noise Control. 4 (2): 11, March 1958. Case histories on chain drives, pinch rollers, tumbling barrels, vacuum pumps, supercharger test stand, boiler fabricating operations.
- P.13 Hydraulic pumps
- Dean, R. C. Origins of Noise in Hydraulic Pumps. Proc. Inter-Noise 72: 249 (1972). Discusses chief noise sources in lobe and lug type pumps, and how to interpret measurements and inlet conditions.
 - Miller, J. E. Silencing the Noisy Hydraulic System. Machine Design: June 14, 1973, p. 138-143.
 - Parker Hannifin Co. Reducing the Operating Noise of Industrial Hydraulic Systems. 1972. Exhaustive and informative treatment, with excellent list of noise reduction techniques.
- P.14 Materials, composite
- Cavanaugh, W. V. Composite Materials for Noise Reduction. Proc. Inter-Noise 72 Tutorial, p. 59 (1972). Discussion of many materials, advantages and shortcomings.
 - Miller, R. K. Acoustical Materials for the Food Process Industry. Proc. Noise-Con 73: 519 (1973). Gives noise levels, sanitary constraints on absorption materials, and isolator selection.
- P.15 Pipes
- Dear, T. A. Noise Reduction Properties of Selected Pipe Covering Configurations. Proc. Inter-Noise 72: 138 (1972). Exhaustive study of many pipe lagging systems for reducing radiating noise, under controlled conditions. Excellent reference.
- P.16 Product noise
- Guinter, J. J. Action Plan for Product Noise Reduction. Sound/Vibration. 6 (12): 18, December 1972. Outlines procedures.
- P.17 Pumps, centrifugal
- Evans, L. M. Control of Vibration and Noise from Centrifugal Pumps. Noise Control. 4 (1): 28, January 1958. Emphasizes selection and proper operating point.
- P.18 Punch press
- Allen, C. H., and R. C. Ison. A Practical Approach to Punch Press Quieting. Noise Control Engineering: Vol. 3, No. 18, 1974

- Bruce, R. B. Noise Control of Metal Stamping Operations. Sound/Vibration. 5 (11): 41, November 1971. Absorption, partial and total enclosures are discussed. Control at the source is also considered.
 - Shinaishin, O. A. Punch Press Diagnostics and Noise Control. Proc. Inter-Noise 72: 243 (1972). Suggests changes in die, stock, snubbers, perforated plates, enclosures.
- P.19 Refinery noise
- DeBiase, J. L. Criteria and Design Specifications for Plant Noise Control. Sound/Vibration. 6 (9): 26, September 1972. Good listing of sources, control procedures. Also where to measure OSHA levels.
- P.20 Screw machine
- Schweitzer, B. V. Silent Stock Tube for Automatic Screw Machines. Noise Control. 2 (2): 14, March 1956. Describes development use of stock tubes with damping.
- P.21 Silencers
- Sanders, G. J. Silencers: Their Design and Applications. Sound/Vibration. 2 (2): 6, February 1968. Describes types, and attenuation/frequency characteristics. Useful data on materials resistant to high temperatures, flow velocities.
- P.22 Sound power measurement
- Huebner, G. Sound Power Determination of Machines in situ. Proc. Inter-Noise 72: 381 (1972). Discusses errors from being in near field, from finite number of measurements, from measurement error, and from room reflections. Latter unimportant if area ratio (total absorption in room)/(area of measuring surfaces) is greater than 10.
- P.23 Stack noise
- Hersh, A. S., et al. Refinery Auxiliary Stack Redesign to Eliminate Induced Resonant Tone. Proc. Noise-Con 73: 441 (1973). Many small changes, including avoiding turbulence, are described.
- P.24 Valve noise
- Heymann, F. J. Some Experiments Concerning Control Valve Noise. Proc. Noise-Con 73: 382 (1973). Several plug and seat configurations are described. Much useful data on getting data from which to predict noise from scale models.
- P.25 Vibration and radiated power
- Chan, C.M.P., and D. Anderson. Correlation of Machine Structure Surface Vibration and Radiated Noise. Proc. Inter-Noise 72: 261 (1972). Mean square velocity or acceleration correlates well with sound power.

- P.26 Vibration and shock isolation
- Miller, H. T., et al. Practical Design of Machinery Foundations for Vibration and Noise Control. Proc. Inter-Noise 72: 185 (1972). Discusses real life parameters that must be considered.
- P.27 Woodworking industry
- Christman, R. P., et al. Sound Pressure Levels in the Wood Products Industry. Noise Control. 2 (5): 33, September 1956. Octave spectra for many machines.

Additional specific references used in the case histories are included as footnotes to the specific case.